



Technical catalogue | March 2015

System pro *E* power

New main distribution switchboards up to 6300A

Power and productivity
for a better world™



System pro *E* power

Technical catalogue

[Range presentation](#)

1

[Structure](#)

2

[Internal kits](#)

3

[Dedicated solution](#)

4

[Main distribution systems](#)

5

[Segregations](#)

6

[Technical details and certifications](#)

7

[Overall dimensions](#)

8

[List of codes](#)

9

ABB SACE Division - Quality, ethics and environmental certification

ABB SACE, a division of ABB S.p.A., has always been at the forefront when it comes to dedicating consistent resources for the purpose of attaining its sustainability and environmental protection goals.

A policy confirmed by acquisition of ISO 9001 quality certification and ISO 14001 environmental management system certification by all the corporate plants.

Thanks to use of analysis tools like LCA (Life Cycle Analysis), assessment and improvement of the environmental performance of the entire life cycle of the products is included in ABB SACE's design engineering work right from the very start.

This guarantees technical and energy performance optimization during operation and control, as well as reduction of environmental impact during the manufacturing phase and end of life management process.

The Garbagnate Monastero plant has also obtained certification for its QAS (Quality, Environment, Safety) integrated management system.

All the corporate divisions have always actively pursued policies for environmental management improvement implemented by rationalizing the use of raw materials and energy, preventing pollution, monitoring air and water quality, reducing noise emissions and the waste created by the production processes as well as conducting regular environmental audits with the major suppliers.

Each of these goals and tasks is the result of a farsighted decision to adopt environmental policies and methods for reducing environmental impact. Already a leading enterprise as to the quality of its products, ABB SACE is also a pacesetter in Italy with regard to these issues.



ABB: Energy efficiency for sustainable progress



ABB is actively committed to promoting environmental protection and sustainable development by providing products and solutions that help to improve the energy efficiency and productivity of the installations while reducing CO₂ emissions.

The ABB SACE website: makes your work easier, develops your business

- **News**, to keep you up to date about the latest electrical engineering innovations
- **Products**, just a simple click for an overview of ABB SACE products 24 hours a day
- **Catalogues** that you can consult, download and request
- **Technical documentation** where you can check circuit diagrams, dimensional drawings, instruction sheets, installation manuals
- **Work tools** for designing in complete safety
- **Training**, where you can consult the training catalogue and register for courses online



Technical software Calculation and cost estimate tools e-Design: everyone has a project, ABB has a solution to make it happen.

e-Design is the integrated suite, designed and created by ABB, dedicated to designers, technicians, engineering companies, panel builders and wholesalers. Thanks to e-Design you can design an electrical installation and optimize the processing time, while benefiting from a product portfolio you can use in synergy and with intuitive and simple functions.

We would like to highlight several positive features:

FLEXIBILITY

- 4 interconnected modules accessible during all stages of the project
- Projects that can be reused by all the professionals involved in their creation

VELOCITY

- You can save, duplicate and edit product and switchboard configurations
- User-friendly configuration of switchboards and products
- Calculation of single-line diagrams and automatic dimensioning of conductors and control and protection equipment

SIMPLICITY

- You can draw single-line diagrams using predefined macros
- User-friendly configuration of switchboards and products

The software comprises four different modules for different purposes. One single process includes electrical system dimensioning, selection and configuration of products and accessories, switchboard configuration and cost estimates. Everything is much easier than in the past. Each individual module allows you to work on the details, but is also closely connected with the other modules. Using separate modules, design engineers can make a precise calculation of whole electrical system, then select equipment to suit the established electrical requirements and create a switchboard configuration. Finally, if the result is not sufficiently feasible, more detailed calculations can be made with the switchboard engineering module.

Here are some of the new purpose-made properties that make this process enjoyable:

- Easy drawing of single-line diagrams, both as regards power distribution and command and control circuits
- Simple and immediate selection and configuration of products, even for those who are not familiar with ABB products, simply by defining technical features
- The automatic user-friendly design process based on the list of devices simplifies one of the most complex design stages and avoids compatibility errors between products, assembly kits and busbar systems
- Effective product organization with tree views, so that the user can work methodically, view the relevant product immediately and define the switchboards with ease
- Availability of a dedicated module for busbar configuration

Well aware of market requirements, ABB now capitalizes on its experience and presents the new e-Design suite as a practical answer to every critical aspect of the design process.

www.abb.it/lowvoltage

The ABB SACE website will help you in your daily work with an innovative approach to the world of low voltage electrical installations and industrial automation.

e-Design

e-Design suite is structured with four integrated functional modules, allowing it to support all planning stages of an electrical installation. All solutions are studied in detail, from electrical network dimensioning, to switchboard configuration, through to the final cost estimate stage. The registration procedure is very easy and, once completed, you can immediately download installers and upgrades.



- DOC** Electrical Installation Dimensioning
- EDS** Switchboard Configuration
- PDC** Switchboard Engineering
- CAT** Product Selection and Configuration

The suite's appealing and brand-new look, combined with general optimization of the functions that have always characterized ABB software, make it an innovative tool, up to date with the technologies currently available in the sector.

After only a brief introduction, the user can already design, calculate, archive and perform project planning. No special CAD skills are required. Software operation is based on dialog boxes. The user is led through the program.

ABB SACE Division and its environmental protection commitment

Among the enterprises belonging to the Group, ABB SACE is in the forefront when it comes to dedicating consistent resources to its sustainable development and environmental protection goals. A policy confirmed by acquisition of ISO 9001 quality certification and ISO 14001 environmental management system certification by all the corporate plants as well as Integrated Quality, Environment, Safety Management System certification for the majority of business units.

Each of these goals and tasks is the result of a farsighted decision to adopt environmental policies and methods for reducing environmental impact. Already a leading enterprise as to the quality of its products, ABB SACE is also a pacesetter in Italy with regard to these issues.

Indeed, all the corporate divisions actively pursue policies for environmental management improvement implemented by rationalizing the use of raw materials and energy, preventing pollution, monitoring air and water quality, reducing noise emissions and the waste created by the production processes as well as conducting regular environmental audits with the major suppliers.

Thanks to use of analysis tools like LCA (Life Cycle Analysis), assessment and improvement of the environmental performance of the entire life cycle of the products is included in ABB SACE's design engineering work right from the very start. This with a view to optimizing the technical and energy performance, controlling and reducing environmental impact during the manufacturing phase and allowing the product end of life management process to be defined.



ABB: quality of the certified product

ABB dedicates consistent resources for the purpose of attaining its quality and environmental protection goals, as testified by the following certifications obtained by the company:



System pro E power

User's guide



Chapter 1
Range presentation
Overview, introduction and advantages of the new main distribution switchboard range up to 6300A.



Chapter 5
Segregations
Segregation kits up to Form 4b available for busbar and breakers with front/rear terminal.



Chapter 2
Structure
Distinctive features of the new switchboards with selection guides for rapid choice of the structure. Ordering codes for the framework and external covers.



Chapter 6
Technical details, certifications and configuration examples.
Specifications of the new switchboard, regulatory framework, Italian and international certifications.



Chapter 3
Internal kits
Assembly kits for the circuit-breakers and the accessories available for the new switchboard solution.



Chapter 7
Overall dimensions
Overall dimensions of the switchboards and the relative components available.

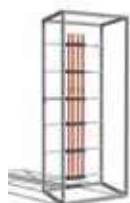

Chapter 4
Main distribution systems
Description of the different busbar system combinations that can be created. Selection guides and capacity tables.



Chapter 8
List of codes
Analytical list of codes.

System pro *E* power

Range presentation

Range presentation

Introduction	1/2
Advantages	1/4
Flexibility	1/4
Velocity	1/5
Simplicity	1/5

Composition of the series	1/6
---------------------------	-----

System pro E power

Range presentation

1

System pro E power, ABB's pioneering new solution for main distribution switchboards with rated current up to 6300A and short-circuit current up to 120kA, meets all plant requirements depending on the type of installation, required degree of protection and the electrical and mechanical specifications.

Introduction

Thanks to the new switchboard, ABB can provide complete solutions for main electric power distribution in infrastructures and industries, in accordance with the regulatory framework. Typical fields of application are airports, subways, hospitals, industrial and residential estates, ports, tunnels, railways, theatres, etc.

In addition, System pro E power guarantees full synergy with all the other ABB apparatus (i.e. modular circuit-breakers, Tmax T and XT moulded-case circuit-breakers, Emax 2 air circuit-breakers) while being extremely simple to assemble and ensuring ease of wiring. Great attention has been made to the wiring requirements, with adequately sized structures and pre-engineered sites for mounting the horizontal and vertical plastic ducts.

The switchboards comprise the following components:

- **Structure:** simple and quick to assemble. Stability is ensured thanks to the new double-surface profile of the upright and the new patented joining system.
- **Internal kits:** designed to integrate ABB's low voltage products. Save time during the assembly work thanks to the patented new click-in mounting system.
- **Main distribution systems:** available in the linear and scaled versions. Allow the busbars to be installed in any position, horizontally or vertically.



Main characteristics of the series

Compliance with Standard	IEC 61439-1-2	
Vibration test	In accordance with Standard IEC 60068-2-57	
Seismic withstand capability test	In accordance with Standard IEE Std 693	
Rated service voltage Ue	up to 1000V AC - 1500V DC	
Rated insulation voltage Ui	up to 1000V AC - 1500V DC	
Rated frequency	50-60Hz	
Rated impulse withstand voltage Uimp	12kV	
Rated current In	up to 6300A	
Rated short-time withstand current Icw	up to 120kA	
Rated peak short-circuit current Ipk	up to 264kA	
IP protection class	IP30, IP31, IP40, IP41, IP65	
Functional dimensions	Height (mm)	1800, 2000mm
	Width (mm)	300, 400, 600, 800, 1000, 1250mm
	Depth (mm)	200, 300, 500, 700, 900mm



System pro *E* power Range presentation

1

The range of System pro *E* power structures can be used to create lots of switchboard configurations while guaranteeing flexibility and a certified product. Up to 120 different configurations can be assembled with a just a few part numbers. This new series features a structure in hot-dip galvanized sheet steel that guarantees equipotential bonding of the switchboard.

IP protection degrees for all types of applications, i.e. up to IP65, can be obtained. It's the only switchboard to reach such a high value. Certification was achieved after stringent tests involving the entire configuration (structure, circuit-breakers and busbar system), thus systems conforming to the new international standard IEC 61439-1-2 can be created by following ABB's instructions.

ABB apparatus can be installed inside the switchboards with high-level integration and optimized use of the available space thanks to the new modules, i.e. 150mm in height, as well as the usual 200mm modules. The circuit-breakers can be internally separated from Form 1 to Form 4b.

Advantages

The System pro *E* power switchboard range is based upon three fundamental criteria that define its practical characteristics and advantages for the users.

Flexibility

The structure can be assembled to suit different logic sequences.

Just a few part numbers for 120 enclosure sizes.

Can be assembled with or without plinth.

Upright with two different surface levels per side so that different kits can be installed.

New ergonomic handle allowing the door to be opened towards the right or left.

New busbar systems using the same components: cross-pieces, mounting plates and multifunction insulating supports able to house 5 or 10mm thick flat or shaped busbars.

Flexible busbar connections.



Velocity

New mounting plates with rapid click-in system.

Panels with ¼-turn screws.

Circuit-breaker kits fixed straight onto the uprights.

Internal segregation partitions created by simply adding accessories in sequence.

New handle allowing different inserts to be housed.

Simplicity

New, simple assembly sequence.

Error-free assembly of the structure, which is perfectly symmetrical.

Modular uprights and cross-pieces joined together by means of a patented new system with axial screws.

Dedicated kits for 3-pole moulded-case circuit-breakers and common kits for 3- and 4-pole moulded case circuit-breakers.

Same front panels for fixed and swing frames, and for screwed and hinged solutions.

Two front panel height sizes available (150 and 200mm) for the DIN rail kit.

All this, plus an ultra-sturdy and safe construction, thanks to the new laser-beam welded upright with 13 folds.



System pro E power

Composition of the series

1

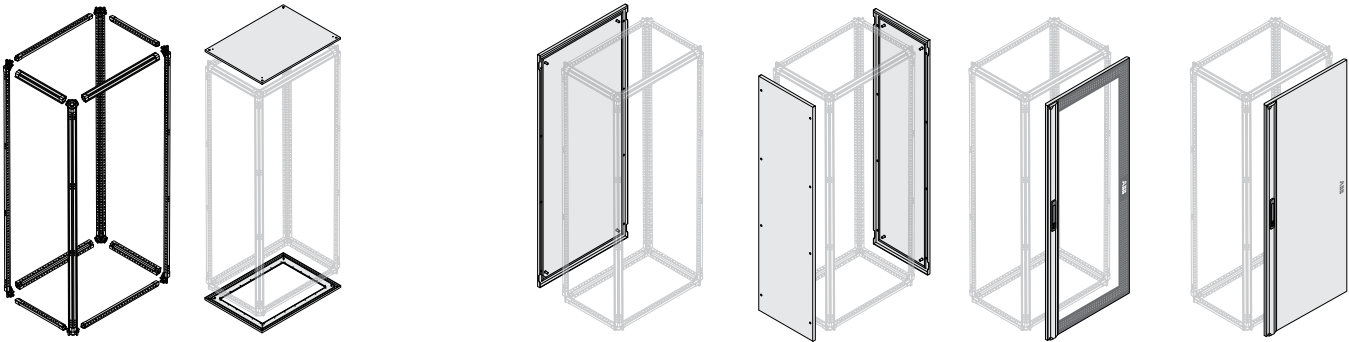

STRUCTURE

EXTERNAL COVERS

Functional dimensions			Top/Bottom		Rear panel		Side panels		Door					
			Blind	Open ⁽¹⁾	Internal bottom	Blind	Vented	Blind	Vented	Glass		Blind		
H (mm)	W (mm)	D (mm)	IP30 to 65	IP65	IP40	IP30 to 65	IP30 to 41	IP30 to 65	IP30 to 41	IP40/41	IP65	IP40/41	IP65	
1800 2000	300	200	■	■	■	■	■	■	■			■	■	
		300	■	■	■	■	■	■	■			■	■	
		500	■	■	■	■	■	■	■			■	■	
		700	■	■	■	■	■	■	■			■	■	
		900	■	■	■	■	■	■	■			■	■	
	400	200	■	■	■	■	■	■	■	■	■	■	■	■
		300	■	■	■	■	■	■	■	■	■	■	■	■
		500	■	■	■	■	■	■	■	■	■	■	■	■
		700	■	■	■	■	■	■	■	■	■	■	■	■
		900	■	■	■	■	■	■	■	■	■	■	■	■
	600	200	■	■	■	■	■	■	■	■	■	■	■	■
		300	■	■	■	■	■	■	■	■	■	■	■	■
		500	■	■	■	■	■	■	■	■	■	■	■	■
		700	■	■	■	■	■	■	■	■	■	■	■	■
		900	■	■	■	■	■	■	■	■	■	■	■	■
	800	200	■	■	■	■	■	■	■	■	■	■	■	■
		300	■	■	■	■	■	■	■	■	■	■	■	■
		500	■	■	■	■	■	■	■	■	■	■	■	■
		700	■	■	■	■	■	■	■	■	■	■	■	■
		900	■	■	■	■	■	■	■	■	■	■	■	■
1000	200	■	■	■	■	■	■	■	■	■	■	■	■	
	300	■	■	■	■	■	■	■	■	■	■	■	■	
	500	■	■	■	■	■	■	■	■	■	■	■	■	
	700	■	■	■	■	■	■	■	■	■	■	■	■	
	900	■	■	■	■	■	■	■	■	■	■	■	■	
1250	200	■	■	■	■	■	■	■	■	■	■	■	■	
	900	■	■	■	■	■	■	■	■	■	■	■	■	

⁽¹⁾ Use the dedicated incoming cable flanges to obtain protection class IP65.

System pro E power Structure

General information 2/2

Choice of the structure

H=1800mm quick selection guide 2/8

H=2000mm quick selection guide 2/10

Guide to the order codes 2/14

Order codes

Frame 2/15

External covers 2/20

Finishing components 2/34

Accessories and spare parts 2/36

2

System pro E power

General information

The range of System pro E power structures can be used to create lots of switchboard configurations while guaranteeing scalability, flexibility and a certified product.

2

Structure

The structure can be assembled in different ways. Moreover, assembly is error-free since the uprights and crosspieces are symmetrical. The structure comprises:

- Uprights and crosspieces
- Plinth and flanges
- Top/Bottom
- Door and panels

To ensure the utmost freedom of choice, flexibility and to save on storage space, the components that form the structure are supplied loose, each one identified by an order code.

Uprights and crosspieces

The uprights and crosspieces (width and depth) have the same laser-beam welded 13-fold profile and are assembled by means of a patented new joining system with 3 axial screws that makes the switchboard incredibly sturdy. The uprights are available in galvanized sheet metal or AISI 304 stainless steel for $I_n > 4000A$ rated current values, able to limit stray currents.

Thanks to its shape, the new profile provides 2 surface levels on the same side to allow different kits to be mounted.

The holes made inside are an important innovation, i.e. the 25mm pitch alternation between a round hole and a square one. Self-threading screws can be inserted into the round holes while the square hole has been created for fastening kits.

The holes made on the outside are different, since there are two round holes with different diameters able to take self-threading screws and round cage nuts. The two different types of holes alternate with a 25mm pitch as required by the DIN Standards.

Functional dimensions available

Type of installation	Dimensions
Height (functional)	1800, 2000mm
Width (functional)	300, 400, 600, 800, 1000, 1250mm
Depth (functional)	200, 300, 500, 700, 900mm

Structures with blind door

W (mm)	300	400	600	800	1000	1250*
DIN modules		12	24	36	48	-

* Double door version with overlapping closing.



New laser-beam welded upright with 13 folds. Extremely sturdy without being too heavy.

Plinth and flanges

The innovative plinth angle piece featuring a patented “folding” system guarantees high-level mechanical strength and can be fastened from the inside and outside of the structure. The switchboard can also be ordered without plinth and, if required by the project specifications or requested by the end customer, the plinth angle piece can be fixed to the structure in a successive stage. The plinth has an anti-rotation device for easier transport on transpallets. The reinforced version is available on request and allows the switchboard to be moved on rollers.

Top/Bottom

New types of top/bottom have been used so as to allow cables to enter from above or below, also thanks to the special flanges that guarantee the desired IP class.

Door and Panels

The doors are available in the glass or blind versions and open through 135° on single units. Door opening through 180° can be obtained on request. For maximum flexibility and ease of use, the hinges are no longer fixed to the uprights but are supplied in the door package. The handle is not fixed and allows the user to choose whether the door must open towards the right or left. The handle can house various types of closing inserts (double tab, key-operated, etc.).

The panels are fixed with TORX screws and come in the RAL7035 orange peel.

Structures with glass door

W (mm)	400	600	800	1000	1250*
DIN modules	12	24	36	48	-

* Double door version with overlapping closing.

Structures with glass door and internal cable compartment

W (mm)	600	800	1000
DIN modules	12	12/24	24/36



System pro E power

General information

Frame

Uprights and crosspieces

- New profile with 2 surface levels on the same side to allow different kits to be mounted.
- Uprights and crosspieces in galvanized sheet metal or AISI 304 stainless steel for $I_n > 4000A$ rated current values, able to limit stray currents.
- Easy to assemble: new joining system with 3 axial screws.
- Extremely sturdy: 13 laser-beam welded folds.
- Small packages.
- Internal kits mounted with a rapid system using 1/4-turn screws.

Plinth

- High-level mechanical strength.
- Can be fixed from the outside and from the inside of the structure.
- Can be fixed to the structure in a successive phase.
- Plinth angle piece with anti-rotation system.
- Bottom can be transported on a transpallet.



New 3-way connection in aluminium. Allows the plinth to be assembled and the structure to be lifted. Double-profile uprights for mounting accessories and kits at different depths.



New plinth with high-level mechanical strength. Equipped with anti-rotation system. Thanks to its innovative shape, it can be fixed from the inside and outside of the structure.



Structural crosspieces for depth and width
in galvanized sheet metal or AISI 304
stainless steel

Pag.2/13

Uprights in galvanized sheet metal or AISI
304 stainless steel

Pag.2/12

Universal angle pieces for plinths in
galvanized sheet metal

Pag.2/14

Plinth flanges in galvanized sheet metal
painted in RAL 7012 orange peel

Pag.2/15

System pro *E* power

General information

External covers

The new design partly reflects ABB's distinctive, classic style while System pro *E* power adds to the elegant appearance without forgoing functionality or sturdiness. The family feeling proposed by the versions and accessories in ABB's range is underscored throughout, thereby guaranteeing the utmost flexibility as to assembly. Thanks to the handle, which can house different types of closing inserts and is supplied with the door hinges (no longer fixed to the upright), a vast range of assembly solutions can be obtained to suit the customers' requirements. It is impossible to commit errors when assembling the structure. Ease of assembly is guaranteed since the hinges are no longer already fixed to the uprights but are supplied with the door and panel accessories. Tops and bottoms are not pre-assembled but supplied separately to allow different incoming-outgoing combinations to be obtained. The new main distribution switchboards are available in versions with glass or blind doors.

Doors and panels

- Family feeling that reflects in all the versions/applications/installations (glass door, blind door).
- The handle allows different inserts to be used.
- The handle and hinges are supplied disassembled. This allows the customer to choose whether the door must open towards the right or left.



The handle can house different types of closing inserts and comes with hinges no longer fixed to the uprights, but supplied with the door and panel accessories.



The stylish handles are customized with the ABB logo.





Blind top/bottom, open bottom and for applications without plinth for up to IP65 degree of protection in pickled steel sheet painted in RAL 7035 orange peel.

Pag.2/16

Glass door or blind door in pickled steel sheet painted in RAL 7035 orange peel, up to IP65 degree of protection.

Pag.2/24

External rear panel in pickled steel sheet painted in RAL 7035 orange peel, up to IP65 degree of protection.

Pag.2/20

External side panel in pickled steel sheet painted in RAL 7035 orange peel, up to IP65 degree of protection.

Pag.2/22

Incoming cable flanges in pickled steel sheet.

Pag.2/32

System pro E power

Choice of the structure

H=1800mm quick selection guide

2



Functional dimensions		External dimensions *		FRAME										EXTERNAL COVERS			
Height 1800mm	W (mm)	D (mm)	Height 2013mm		Uprights		Structure crosspieces			H=100mm plinth			Top/bottom panels				
			W (mm)	D (mm)	Galvanized sheet metal In≤4000A	Stainless steel In>4000A	Galvanized sheet metal In≤4000A	Stainless steel In>4000A	Galvanized sheet metal	Plinth flanges	Top/Bottom						
							Front/Rear	Sides	Front/Rear	Sides	Angle pieces	Front/Rear	Sides	IP65	IP30 ⁽¹⁾ IP40 ⁽¹⁾	IP65	Open ⁽²⁾
300	200	316	416	616	PUPM1800	PUPS1800	PCFM0300	PCFM0200	PCFS0300	PCFS0200	PPAM0100	PPFM1030	PPFM1020	PTBB3026	PTBB3020	PTB03020	
	300	416						PCFM0300					PPFM1030	PTBB3036	PTBB3030	PTB03030	
	500	616						PCFM0500					PPFM1050	PTBB3056	PTBB3050	PTB03050	
	700	816						PCFM0700	PCFS0300	PCFS0700			PPFM1070	PTBB3076	PTBB3070	PTB03070	
	900	1016						PCFM0900	PCFS0300	PCFS0900			PPFM1090	PTBB3096	PTBB3090	PTB03090	
400	200	316	516	616	PUPM1800	PUPS1800	PCFM0400	PCFM0200	PCFS0400	PCFS0200	PPAM0100	PPFM1040	PPFM1020	PTBB4026	PTBB4020	PTB04020	
	300	416						PCFM0300					PPFM1030	PTBB4036	PTBB4030	PTB04030	
	500	616						PCFM0500					PPFM1050	PTBB4056	PTBB4050	PTB04050	
	700	816						PCFM0700	PCFS0400	PCFS0700			PPFM1070	PTBB4076	PTBB4070	PTB04070	
	900	1016						PCFM0900	PCFS0400	PCFS0900			PPFM1090	PTBB4096	PTBB4090	PTB04090	
600	200	316	716	616	PUPM1800	PUPS1800	PCFM0600	PCFM0200	PCFS0600	PCFS0200	PPAM0100	PPFM1060	PPFM1020	PTBB6026	PTBB6020	PTB06020	
	300	416						PCFM0300					PPFM1030	PTBB6036	PTBB6030	PTB06030	
	500	616						PCFM0500					PPFM1050	PTBB6056	PTBB6050	PTB06050	
	700	816						PCFM0700	PCFS0600	PCFS0700			PPFM1070	PTBB6076	PTBB6070	PTB06070	
	900	1016						PCFM0900	PCFS0600	PCFS0900			PPFM1090	PTBB6096	PTBB6090	PTB06090	
800	200	316	916	616	PUPM1800	PUPS1800	PCFM0800	PCFM0200	PCFS0800	PCFS0200	PPAM0100	PPFM1080	PPFM1020	PTBB8026	PTBB8020	PTB08020	
	300	416						PCFM0300					PPFM1030	PTBB8036	PTBB8030	PTB08030	
	500	616						PCFM0500					PPFM1050	PTBB8056	PTBB8050	PTB08050	
	700	816						PCFM0700	PCFS0800	PCFS0700			PPFM1070	PTBB8076	PTBB8070	PTB08070	
	900	1016						PCFM0900	PCFS0800	PCFS0900			PPFM1090	PTBB8096	PTBB8090	PTB08090	
1000	200	316	1116	616	PUPM1800	PUPS1800	PCFM1000	PCFM0200	PCFS1000	PCFS0200	PPAM0100	PPFM1010	PPFM1020	PTBB1026	PTBB1020		
	300	416						PCFM0300					PPFM1030	PTBB1036	PTBB1030	PTB01030	
	500	616						PCFM0500					PPFM1050	PTBB1056	PTBB1050	PTB01050	
	700	816						PCFM0700	PCFS1000	PCFS0700			PPFM1070	PTBB1076	PTBB1070	PTB01070	
	900	1016						PCFM0900	PCFS1000	PCFS0900			PPFM1090	PTBB1096	PTBB1090	PTB01090	
1250	200	316	1366	1016	PUPM1800	PUPS1800	PCFM1250	PCFM0200	PCFS1250	PCFS0200	PPAM0100	PPFM1250	PPFM1020		PTBB1220		
	900	1016						PCFM0900		PCFS0900			PPFM1090		PTBB1290	PTB01290	

* The external dimensions include the H=100mm plinth and the panels.

Consult page 2/12 and 7/2 for selection of the protection class.

⁽¹⁾ In order to reach IPX1 protection degree it is necessary to add the proper top sealing kit, page 2/23.

⁽²⁾ Use the dedicated incoming cable flanges to obtain protection class IP65.

> Order codes page 2/13 > Technical details page 7/1 > Overall dimensions page 8/1



Front/side panels

Bottom Without plinth	Rear panel			Side panel			Glass door 12/24 36/48 mod. DIN		Glass door 12/24/36 mod. DIN + internal cable compartment				Blind door 12/24 36/48 mod. DIN	
	Blind	Vented		Blind	Vented		IP65	IP40 ⁽¹⁾	Cable comp. W=200mm IP65	Cable comp. W=400mm IP65	Cable comp. W=200mm IP40 ⁽¹⁾	Cable comp. W=400mm IP40 ⁽¹⁾	IP65	IP40 ⁽¹⁾
		IP65	IP30 ⁽¹⁾ IP40 ⁽¹⁾		IP30 ⁽¹⁾	IP65								
PBWP3020				PPEB1826	PPEB1820									
PBWP3030				PPEB1836	PPEB1830	PPEA1830								
PBWP3050	PPEB1836	PPEB1830	PPEA1830	PPEB1856	PPEB1850	PPEA1850							PDLB1836	PDLB1830
PBWP3070				PPEB1876	PPEB1870	PPEA1870								
PBWP3090				PPEB1896	PPEB1890	PPEA1890								
PBWP4020				PPEB1826	PPEB1820									
PBWP4030				PPEB1836	PPEB1830	PPEA1830								
PBWP4050	PPEB1846	PPEB1840	PPEA1840	PPEB1856	PPEB1850	PPEA1850	PDLG1846	PDLG1840					PDLB1846	PDLB1840
PBWP4070				PPEB1876	PPEB1870	PPEA1870								
PBWP4090				PPEB1896	PPEB1890	PPEA1890								
PBWP6020				PPEB1826	PPEB1820									
PBWP6030				PPEB1836	PPEB1830	PPEA1830								
PBWP6050	PPEB1866	PPEB1860	PPEA1860	PPEB1856	PPEB1850	PPEA1850	PDLG1866	PDLG1860	PDLG1842		PDLG8420		PDLB1866	PDLB1860
PBWP6070				PPEB1876	PPEB1870	PPEA1870								
PBWP6090				PPEB1896	PPEB1890	PPEA1890								
PBWP8020				PPEB1826	PPEB1820									
PBWP8030				PPEB1836	PPEB1830	PPEA1830								
PBWP8050	PPEB1886	PPEB1880	PPEA1880	PPEB1856	PPEB1850	PPEA1850	PDLG1886	PDLG1880	PDLG1862	PDLG1844	PDLG8620	PDLG8440	PDLB1886	PDLB1880
PBWP8070				PPEB1876	PPEB1870	PPEA1870								
PBWP8090				PPEB1896	PPEB1890	PPEA1890								
PBWP1030					PPEB1820									
PBWP1050	PPEB1816	PPEB1810	PPEA1810	PPEB1836	PPEB1830	PPEA1830	PDLG1816	PDLG1810	PDLG1882	PDLG1864	PDLG8820	PDLG8640	PDLB1816	PDLB1810
PBWP1070				PPEB1856	PPEB1850	PPEA1850								
PBWP1090				PPEB1876	PPEB1870	PPEA1870								
				PPEB1896	PPEB1890	PPEA1890								
PBWP1290		PPRB1820 ⁽⁴⁾ PPLB1820 ⁽⁵⁾	PPRA1820 ⁽⁴⁾ PPLA1820 ⁽⁵⁾		PPEB1820				PDLB8120 ⁽⁶⁾ PDLG8500 ⁽⁷⁾					PDLB8120 ⁽⁶⁾ PDLB8500 ⁽⁷⁾

⁽³⁾ Bottom for switchboard without plinth complete with the dedicated set of brackets, which can be ordered separately.

⁽⁴⁾ Right rear panel for structures W=1250mm.

⁽⁵⁾ Left rear panel for structures W=1250mm.

⁽⁶⁾ Door with overlapping for the double door version.

⁽⁷⁾ Door with handle for the double door version.

System pro E power

Choice of the structure

H=2000mm quick selection guide

2

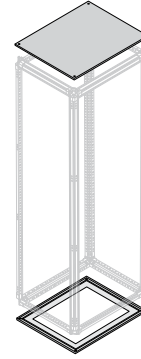
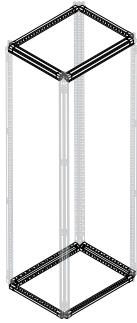
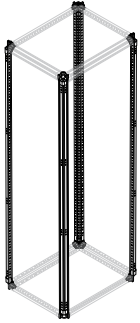

Functional dimensions		External dimensions *		FRAME										EXTERNAL COVERS		
Height 2000mm	W (mm)	D (mm)	Height 2213mm		Uprights		Structure crosspieces			H=100mm plinth			Top/bottom panels			
			W (mm)	D (mm)	Galvanized sheet metal In≤4000A	Stainless steel In>4000A	Galvanized sheet metal In≤4000A		Stainless steel In>4000A		Galvanized sheet metal		Top/Bottom			
							Front/ Rear	Sides	Front/ Rear	Sides	Angle pieces	Front/Rear	Sides	Blind IP65	IP30 ⁽¹⁾ IP40 ⁽¹⁾	Open ⁽²⁾ IP65
300	200	316	416	616	PUPM2000	PUPS2000	PCFM0300	PCFM0200	PCFS0300	PCFS0200	PPAM0100	PPFM1030	PPFM1020	PTBB3026	PTBB3020	PTB03020
	300	416						PCFM0300					PPFM1030	PTBB3036	PTBB3030	PTB03030
	500	616						PCFM0500					PPFM1050	PTBB3056	PTBB3050	PTB03050
	700	816						PCFM0700	PCFS0300	PCFS0700			PPFM1070	PTBB3076	PTBB3070	PTB03070
	900	1016						PCFM0900	PCFS0300	PCFS0900			PPFM1090	PTBB3096	PTBB3090	PTB03090
400	200	316	516	616	PUPM2000	PUPS2000	PCFM0400	PCFM0200	PCFS0400	PCFS0200	PPAM0100	PPFM1040	PPFM1020	PTBB4026	PTBB4020	PTB04020
	300	416						PCFM0300					PPFM1030	PTBB4036	PTBB4030	PTB04030
	500	616						PCFM0500					PPFM1050	PTBB4056	PTBB4050	PTB04050
	700	816						PCFM0700	PCFS0400	PCFS0700			PPFM1070	PTBB4076	PTBB4070	PTB04070
	900	1016						PCFM0900	PCFS0400	PCFS0900			PPFM1090	PTBB4096	PTBB4090	PTB04090
600	200	316	716	616	PUPM2000	PUPS2000	PCFM0600	PCFM0200	PCFS0600	PCFS0200	PPAM0100	PPFM1060	PPFM1020	PTBB6026	PTBB6020	PTB06020
	300	416						PCFM0300					PPFM1030	PTBB6036	PTBB6030	PTB06030
	500	616						PCFM0500					PPFM1050	PTBB6056	PTBB6050	PTB06050
	700	816						PCFM0700	PCFS0600	PCFS0700			PPFM1070	PTBB6076	PTBB6070	PTB06070
	900	1016						PCFM0900	PCFS0600	PCFS0900			PPFM1090	PTBB6096	PTBB6090	PTB06090
800	200	316	916	616	PUPM2000	PUPS2000	PCFM0800	PCFM0200	PCFS0800	PCFS0200	PPAM0100	PPFM1080	PPFM1020	PTBB8026	PTBB8020	PTB08020
	300	416						PCFM0300					PPFM1030	PTBB8036	PTBB8030	PTB08030
	500	616						PCFM0500					PPFM1050	PTBB8056	PTBB8050	PTB08050
	700	816						PCFM0700	PCFS0800	PCFS0700			PPFM1070	PTBB8076	PTBB8070	PTB08070
	900	1016						PCFM0900	PCFS0800	PCFS0900			PPFM1090	PTBB8096	PTBB8090	PTB08090
1000	200	316	1116	616	PUPM2000	PUPS2000	PCFM1000	PCFM0200	PCFS1000	PCFS0200	PPAM0100	PPFM1010	PPFM1020	PTBB1026	PTBB1020	PTB01020
	300	416						PCFM0300					PPFM1030	PTBB1036	PTBB1030	PTB01030
	500	616						PCFM0500					PPFM1050	PTBB1056	PTBB1050	PTB01050
	700	816						PCFM0700	PCFS1000	PCFS0700			PPFM1070	PTBB1076	PTBB1070	PTB01070
	900	1016						PCFM0900	PCFS1000	PCFS0900			PPFM1090	PTBB1096	PTBB1090	PTB01090
1250	200	316	1366	1016	PUPM2000	PUPS2000	PCFM1250	PCFM0200	PCFS1250	PCFS0200	PPAM0100	PPFM1250	PPFM1020		PTBB1220	
	900	1016						PCFM0900					PPFM1090		PTBB1290	PTB01290

* The external dimensions include the H=100mm plinth and the panels.

Consult page 2/12 and 7/2 for selection of the protection class.

⁽¹⁾ In order to reach IPX1 protection degree it is necessary to add the proper top sealing kit, page 2/23.

⁽²⁾ Use the dedicated incoming cable flanges to obtain protection class IP65.

> Order codes page 2/13 > Technical details page 7/1 > Overall dimensions page 8/1



Front/side panels

Bottom Without plinth	Rear panel			Side panel			Glass door 12/24 36/48 mod. DIN		Glass door 12/24/36 mod. DIN + internal cable compartment				Blind door 12/24 36/48 mod. DIN	
	Blind	Vented		Blind	Vented		IP65	IP40 ⁽¹⁾	Cable comp. W=200mm IP65	Cable comp. W=400mm IP65	Cable comp. W=200mm IP40 ⁽¹⁾	Cable comp. W=400mm IP40 ⁽¹⁾	IP65	IP40 ⁽¹⁾
		IP65	IP30 ⁽¹⁾ IP40 ⁽¹⁾		IP30 ⁽¹⁾	IP65								
PBWP3020				PPEB2026	PPEB2020									
PBWP3030				PPEB2036	PPEB2030	PPEA2030								
PBWP3050	PPEB2036	PPEB2030	PPEA2030	PPEB2056	PPEB2050	PPEA2050							PDLB2036	PDLB2030
PBWP3070				PPEB2076	PPEB2070	PPEA2070								
PBWP3090				PPEB2096	PPEB2090	PPEA2090								
PBWP4020				PPEB2026	PPEB2020									
PBWP4030				PPEB2036	PPEB2030	PPEA2030								
PBWP4050	PPEB2046	PPEB2040	PPEA2040	PPEB2056	PPEB2050	PPEA2050	PDLG2046	PDLG2040					PDLB2046	PDLB2040
PBWP4070				PPEB2076	PPEB2070	PPEA2070								
PBWP4090				PPEB2096	PPEB2090	PPEA2090								
PBWP6020				PPEB2026	PPEB2020									
PBWP6030				PPEB2036	PPEB2030	PPEA2030								
PBWP6050	PPEB2066	PPEB2060	PPEA2060	PPEB2056	PPEB2050	PPEA2050	PDLG2066	PDLG2060	PDLG2042		PDLG2420		PDLB2066	PDLB2060
PBWP6070				PPEB2076	PPEB2070	PPEA2070								
PBWP6090				PPEB2096	PPEB2090	PPEA2090								
PBWP8020				PPEB2026	PPEB2020									
PBWP8030				PPEB2036	PPEB2030	PPEA2030								
PBWP8050	PPEB2086	PPEB2080	PPEA2080	PPEB2056	PPEB2050	PPEA2050	PDLG2086	PDLG2080	PDLG2062	PDLG2044	PDLG2620	PDLG2440	PDLB2086	PDLB2080
PBWP8070				PPEB2076	PPEB2070	PPEA2070								
PBWP8090				PPEB2096	PPEB2090	PPEA2090								
PBWP1030					PPEB2020									
PBWP1050	PPEB2016	PPEB2010	PPEA2010	PPEB2036	PPEB2030	PPEA2030								
PBWP1070				PPEB2056	PPEB2050	PPEA2050	PDLG2016	PDLG2010	PDLG2082	PDLG2064	PDLG2820	PDLG2640	PDLB2016	PDLB2010
PBWP1090				PPEB2076	PPEB2070	PPEA2070								
				PPEB2096	PPEB2090	PPEA2090								
PBWP1290		PPRB2020 ⁽⁴⁾ PPLB2020 ⁽⁵⁾	PPRA2020 ⁽⁴⁾ PPLA2020 ⁽⁵⁾		PPEB2020									PDLB2120 ⁽⁶⁾ PDLG2500 ⁽⁷⁾
					PPEB2090	PPEA2090								PDLB2500 ⁽⁷⁾

⁽³⁾ Bottom for switchboard without plinth complete with the dedicated set of brackets, which can be ordered separately.

⁽⁴⁾ Right rear panel for structures W=1250mm.

⁽⁵⁾ Left rear panel for structures W=1250mm.

⁽⁶⁾ Door with overlapping for the double door version.

⁽⁷⁾ Door with handle for the double door version.

System pro E power

Choice of the structure

Realization of the different IP protection class example

2

IP30

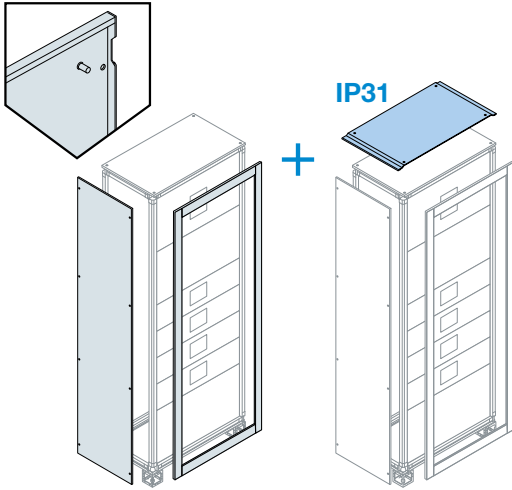

IP40

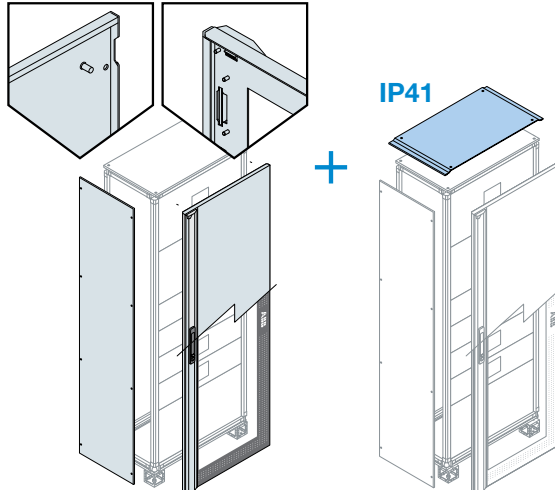

IP30

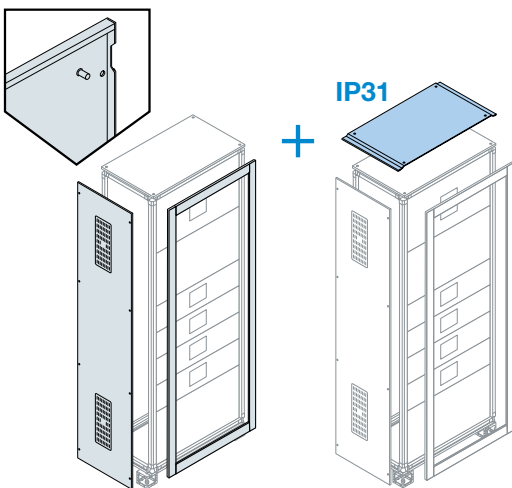

IP40

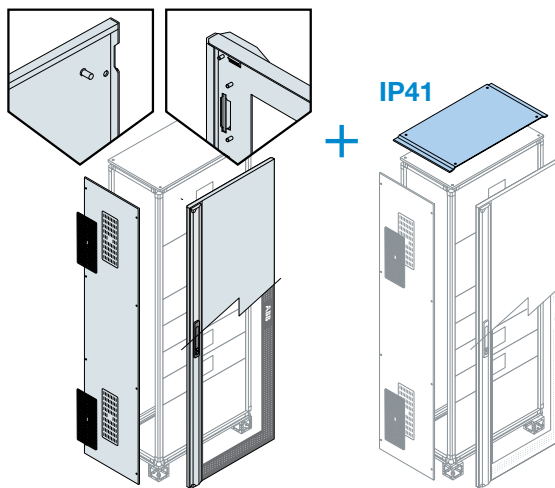

IP65

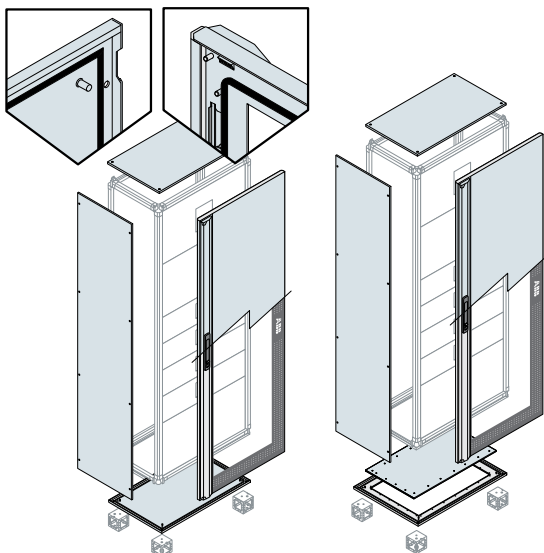

Examples of use

PUCM.... or PUCS...

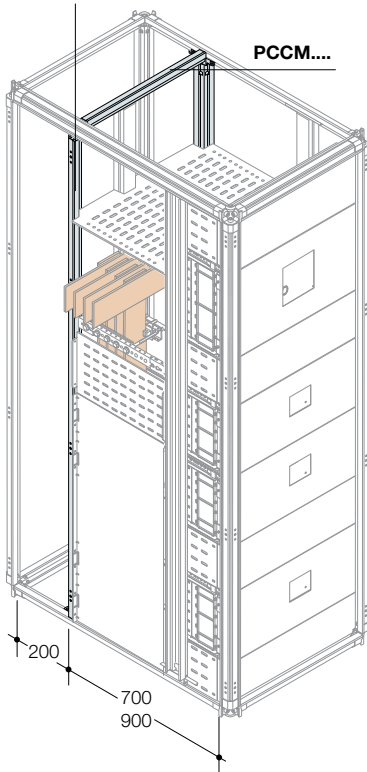

Structure with rear cable compartment: to be realized by means of 2 crosspieces for structure PCCM.... and 2 uprights for internal cable compartment PUCM.... o PUCS....

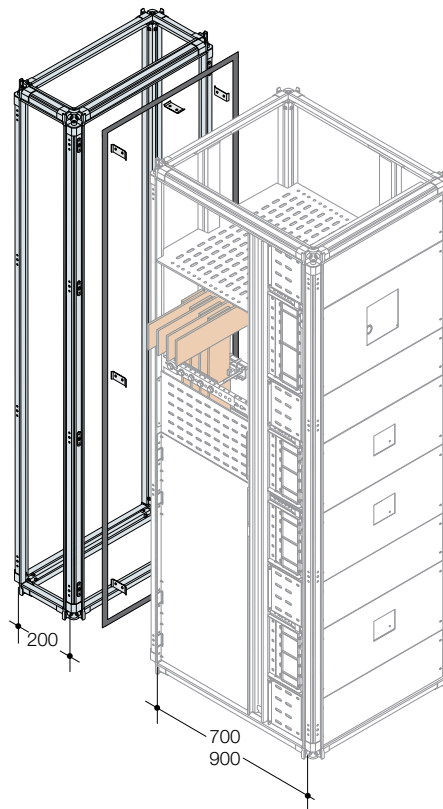

Back to back structures

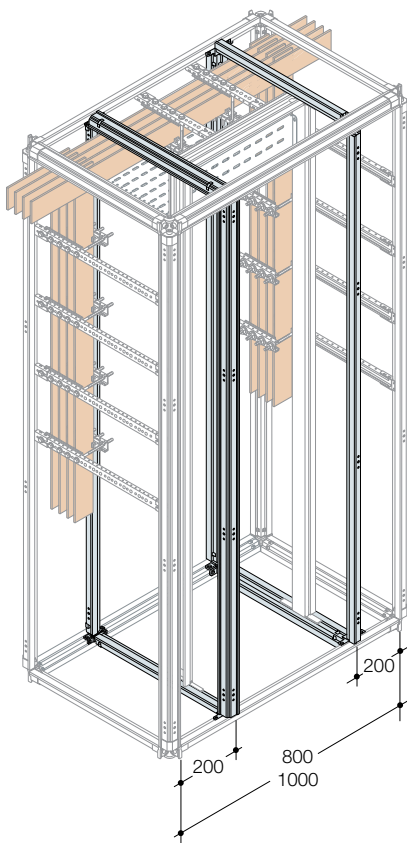

Structure with double internal cable compartment: to be realized by means of crosspieces for internal cable compartment PCCS.... and uprights for internal cable compartment PUCM.... o PUCS....

System pro E power

Guide to the order codes

The new code is formed by 4 letters standing for English terms and 4 numbers, without spaces in between.

2

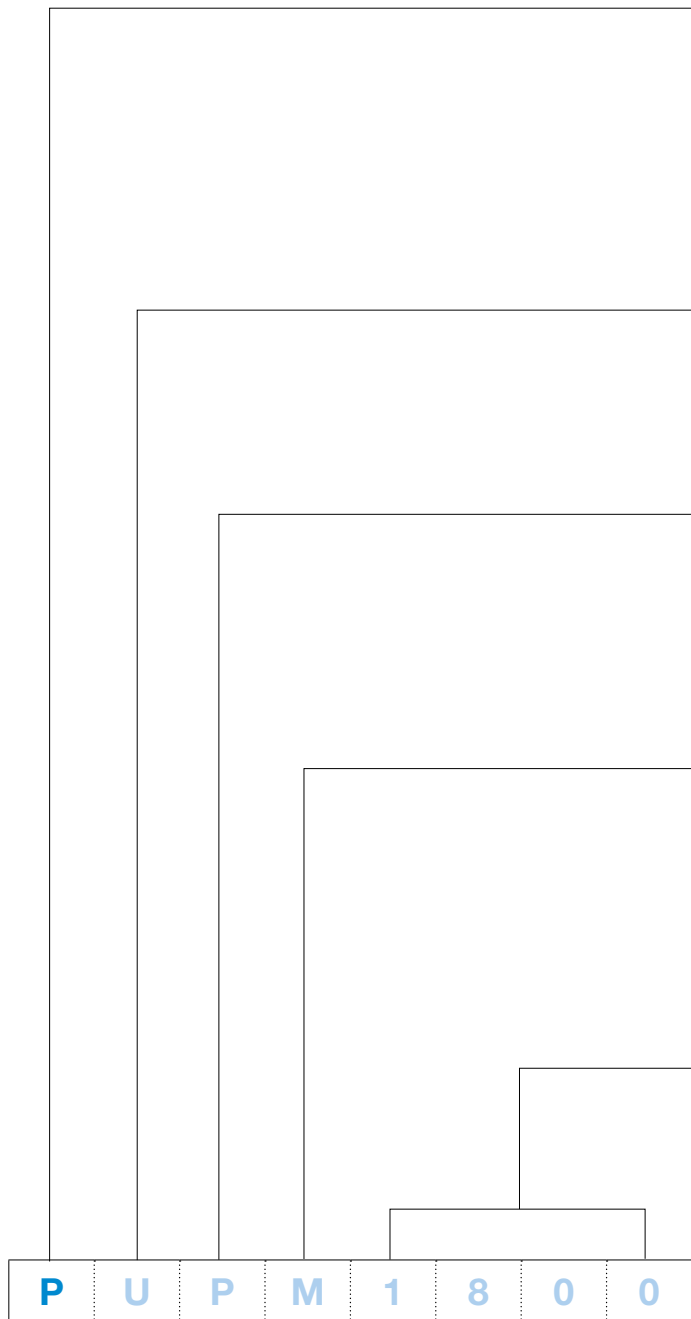

RANGE IDENTIFIER

The first letter of all the codes of the new main distribution switchboard **"P"** stands for **"power"**. Thus the new product is clearly identified by the same initial used for all new components of ABB's System pro E power

TYPE OF PRODUCT AND CHARACTERISTICS

The second letter in the code indicates the type of product or component of the switchboard. The third and fourth letters describe the characteristics or material in more detail.

- U** = Upright
- C** = Crosspieces
- P** = Plinth, Panel, Profile
- T** = Top
- B** = Bottom
- D** = Door
- K** = Kit

- P** = Upright, Profile
- C** = Cable compartment
- F** = Frame, Flanges, Finishing
- A** = Plinth angle pieces
- I** = Intermediate
- B** = Bottom
- W** = Without plinth
- E** = External cover
- D** = Double tab insert

- M** = Metal/Galvanized sheel metal
- S** = Stainless steel
- B** = Blind
- O** = Open
- P** = Plinth
- A** = Vented
- G** = Glass
- H** = Horizontal
- V** = Vertical
- T** = Top

MEASUREMENTS

The last 4 numbers usually refer to one of the component's measurements or to several dimensions concerning the code. In certain cases, if the last number is 6, it refers to the IP65 protection class.

Order codes - Frame

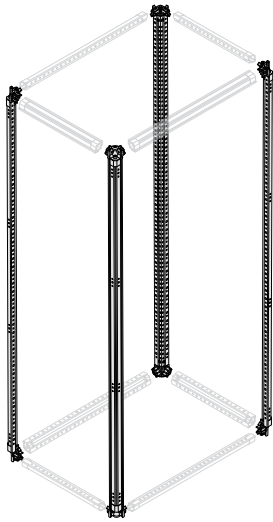

Uprights – Galvanized sheet metal

Upright formed by a closed profile made of galvanized sheet metal. The uprights include 8 already assembled 3-way joints, 8 already assembled axial screws and 16 loose axial screws. For applications with $I_n \leq 4000A$.

Description	Dimensions		Order code	Codice ABB	Package/ No. pcs
	H (mm)				
No.4 galvanized sheet metal uprights	1800		PUPM1800	1STQ007033A0000	1/4
No.4 galvanized sheet metal uprights	2000		PUPM2000	1STQ007034A0000	1/4

Uprights – Stainless steel

Upright formed by a closed profile in AISI 304 stainless steel. The uprights include 8 already assembled 3-way joints, 8 already assembled axial screws and 16 loose axial screws. For applications with $I_n > 4000A$.

Description	Dimensions		Order code	Codice ABB	Package/ No. pcs
	H (mm)				
No.4 stainless steel uprights	1800		PUPS1800	1STQ007061A0000	1/4
No.4 stainless steel uprights	2000		PUPS2000	1STQ007205A0000	1/4

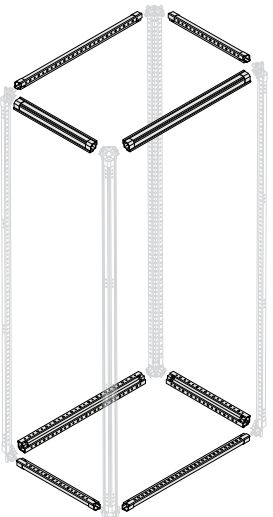

Structure crosspieces – Galvanized sheet metal

Depth and width crosspieces for structures in galvanized sheet metal. For applications with $\leq 4000A$.

Description	Dimensions (mm)		Order code	ABB code	Package/ No. pcs
	W	D			
Width crosspieces					
No.4 width crosspieces galvanized sheet metal	300		PCFM0300	1STQ007037A0000	1/4
No.4 width crosspieces galvanized sheet metal	400		PCFM0400	1STQ007038A0000	1/4
No.4 width crosspieces galvanized sheet metal	600		PCFM0600	1STQ007040A0000	1/4
No.4 width crosspieces galvanized sheet metal	800		PCFM0800	1STQ007042A0000	1/4
No.4 width crosspieces galvanized sheet metal	1000		PCFM1000	1STQ007043A0000	1/4
No.4 width crosspieces galvanized sheet metal	1250		PCFM1250	1STQ007044A0000	1/4
Depth crosspieces					
No.4 width crosspieces galvanized sheet metal		200	PCFM0200	1STQ007045A0000	1/4
No.4 width crosspieces galvanized sheet metal		300	PCFM0300	1STQ007037A0000	1/4
No.4 width crosspieces galvanized sheet metal		500	PCFM0500	1STQ007039A0000	1/4
No.4 width crosspieces galvanized sheet metal		700	PCFM0700	1STQ007046A0000	1/4
No.4 width crosspieces galvanized sheet metal		900	PCFM0900	1STQ007047A0000	1/4

Structure crosspieces – Stainless steel

Depth and width crosspieces for structure in AISI 304 stainless steel. For applications with $I_n > 4000A$.

Description	Dimensions (mm)		Order code	ABB code	Package/ No. pcs
	W	D			
Width crosspieces					
No.4 width crosspieces in stainless steel	300		PCFS0300	1STQ007206A0000	1/4
No.4 width crosspieces in stainless steel	400		PCFS0400	1STQ007062A0000	1/4
No.4 width crosspieces in stainless steel	600		PCFS0600	1STQ007063A0000	1/4
No.4 width crosspieces in stainless steel	800		PCFS0800	1STQ007064A0000	1/4
No.4 width crosspieces in stainless steel	1000		PCFS1000	1STQ007065A0000	1/4
No.4 width crosspieces in stainless steel	1250		PCFS1250	1STQ007066A0000	1/4
Depth crosspieces					
No.4 depth crosspieces in stainless steel		200	PCFS0200	1STQ009174A0000	1/4
No.4 depth crosspieces in stainless steel		700	PCFS0700	1STQ007067A0000	1/4
No.4 depth crosspieces in stainless steel		900	PCFS0900	1STQ007068A0000	1/4

System pro E power

Order codes - Frame

2

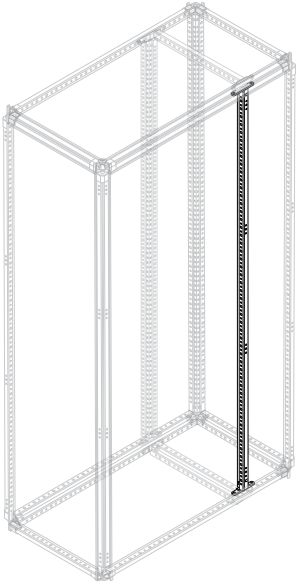

Uprights for internal cable compartment – Galvanized sheet metal

Upright formed by a closed profile in galvanized sheet metal for internal cable compartment with fixing brackets. For applications with $I_n \leq 4000A$.

Description	Dimensions H (mm)	Order code	Codice ABB	Package/ No. pcs
No.1 galv. sheet metal upright for cable compartment	1800	PUCM1800	1STQ007742A0000	1/1
No.1 galv. sheet metal upright for cable compartment	2000	PUCM2000	1STQ007743A0000	1/1

Uprights for internal cable compartment – Stainless steel

Upright formed by a closed profile in AISI 304 stainless steel for internal cable compartment with fixing brackets. For applications with $I_n > 4000A$.

Description	Dimensions H (mm)	Order code	Codice ABB	Package/ No. pcs
No.1 stainless steel upright for cable compartment	1800	PUCS1800	1STQ007749A0000	1/1
No.1 stainless steel upright for cable compartment	2000	PUCS2000	1STQ007750A0000	1/1

The upright is always required. The rear upright is used for fixing the crosspieces that support the busbars and for fixing the vertical side partitions of the structure.

Applications examples

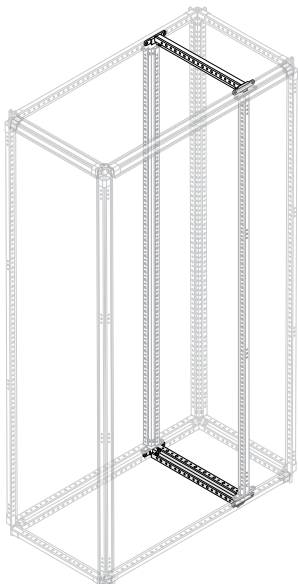
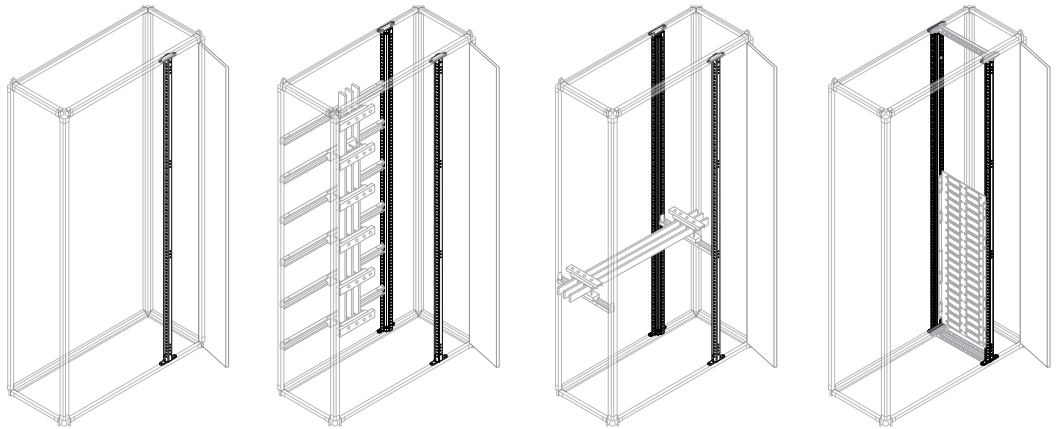

Crosspieces for internal cable compartment – Galvanized sheet metal

Crosspieces for internal cable compartment in galvanized sheet metal. For applications with $I_n \leq 4000A$ with fixing brackets.

Description	Dimen- sions D (mm)	Order code	Codice ABB	Package/ No. pcs
No.2 galvanized sheet cable cont. crosspieces	200	PCCM0200	1STQ007744A0000	1/2
No.2 galvanized sheet cable cont. crosspieces	300	PCCM0300	1STQ007745A0000	1/2
No.2 galvanized sheet cable cont. crosspieces	500	PCCM0500	1STQ007746A0000	1/2
No.2 galvanized sheet cable cont. crosspieces	700	PCCM0700	1STQ007747A0000	1/2
No.2 galvanized sheet cable cont. crosspieces	900	PCCM0900	1STQ007748A0000	1/2

o be ordered when there is an intermediate upright for mounting kit PUKI... or an intermediate crosspiece for installing busbars horizontally under the top or on the bottom of the PCKI... structure or when vertical side partitions are installed.

Not compatible with IP40 PBWP...

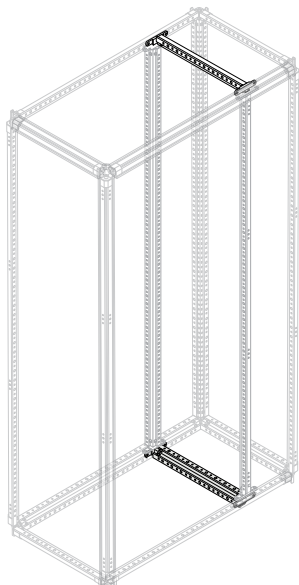

Crosspieces for internal cable compartment – Stainless steel

Crosspieces for internal cable compartment in AISI 304 stainless steel. For applications with In >4000A with fixing brackets

Description	Dimensions (mm) D	Order code	ABB code	Package/ No. pcs
No.2 stainless steel cable cont. crosspieces	700	PCCS0700	1STQ007751A0000	1/2
No.2 stainless steel cable cont. crosspieces	900	PCCS0900	1STQ007752A0000	1/2

To be ordered when there is an intermediate upright for mounting kit PUKI... or an intermediate cross-piece for installing busbars horizontally under the top or on the bottom of the PCKI... structure or when vertical side partitions are installed.

Not compatible with IP40 PBWP...

Applications examples

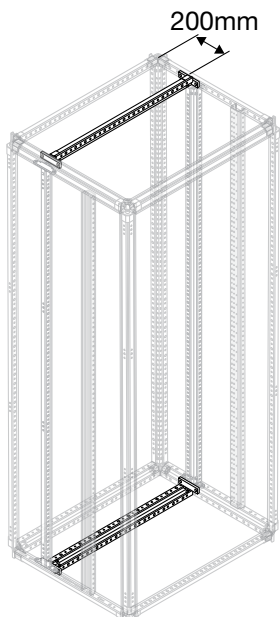
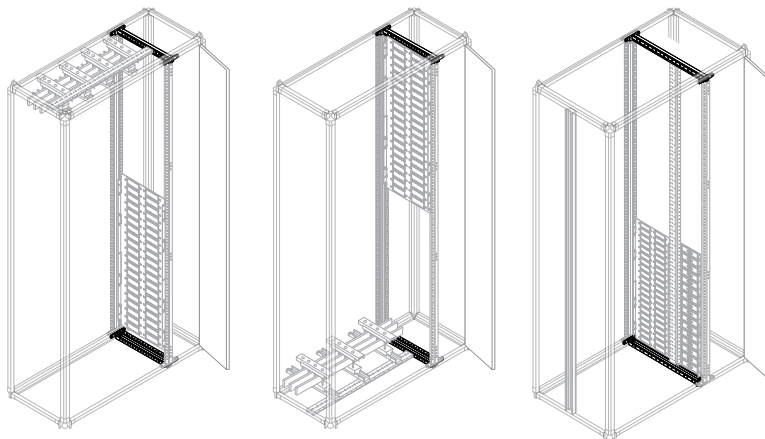

Crosspieces for structures – Galvanized sheet metal

Allows the creation of a cable compartment with D=200mm at the back of the structures. To be assembled with 2 intermediate uprights for internal cable container PUCM... o PUCS...

Description	Dimensions W (mm)	Order code	Codice ABB	Package/ No. pcs
No.2 galvanized sheet crosspieces for structures	400	PCCM0400	1STQ001336B0000	1/2
No.2 galvanized sheet crosspieces for structures	600	PCCM0600	1STQ001337B0000	1/2
No.2 galvanized sheet crosspieces for structures	800	PCCM0800	1STQ001338B0000	1/2
No.2 galvanized sheet crosspieces for structures	1000	PCCM1000	1STQ001339B0000	1/2

System pro E power

Order codes - Frame

2

PPAM0100

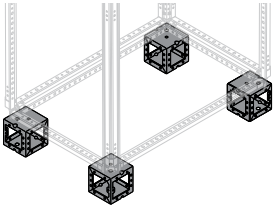

PPAM0200

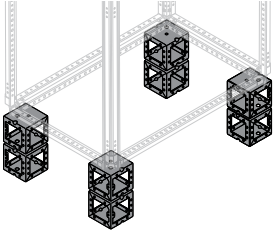

Universal angle pieces for plinths in galvanized sheet metal

Not pre-assembled to the structure. New angle piece with high mechanical strength. Can be fixed from the outside and from the inside of the structure even at a later date. Equipped with anti-rotation system and bottom that can be transported with a transpallet.

Description	Dimensions H (mm)	Order code	ABB code	Package/ No. pcs
No.4 plinth angle pieces	100	PPAM0100	1STQ007048A0000	1/4
No.8 plinth angle pieces H=100mm pre-assembled*	200	PPAM0200	1STQ007207A0000	1/4

*Order no. 2 pieces of H=100mm covering flange kits to complete the H=200mm plinth.

"L" covers for plinth angle-pieces

Used for covering the sides of the plinth when the flanges are not used.

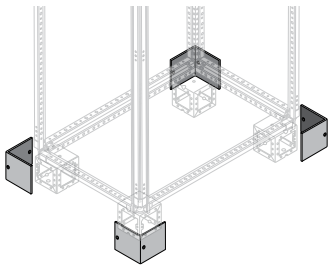

Description	Dimensions H (mm)	Order code	ABB code	Package/ No. pcs
No.4 angle-piece covers	100	PCPA0004	1STQ008109A0000	1/4

PPIM0100

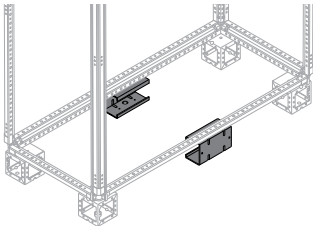

PPIM0200

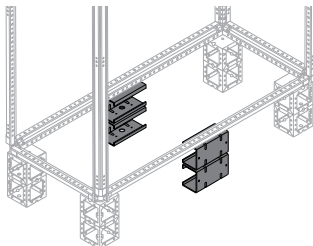

Intermediate plinth

Intermediate plinth only for structures W=1250mm

Description	Dimensions H (mm)	Order code	ABB code	Package/ No. pcs
No.2 intermediate plinths	100	PPIM0100*	1STQ007208A0000	1/2
No.4 intermediate plinths H=100mm pre-assembled*	200	PPIM0200*	1STQ007209A0000	1/2

* Order no. 2 pieces of H=100mm covering flange kits to complete the H=200mm intermediate plinth.

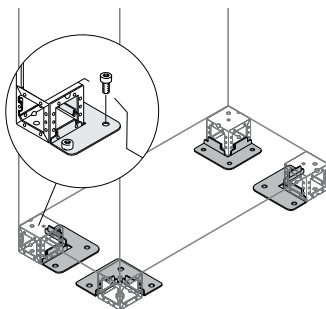

Brackets for fixing to the floor

The kit allows the floor or on container fixing of the structure by means of M12 screws.

Description	Order code	ABB code	Package/ No. pcs
No.4 floor fixing brackets	ZN1041	1STQ006833A0000	1/4

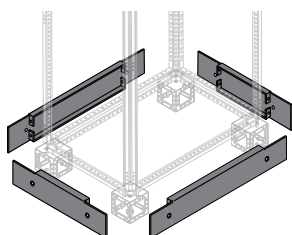

Plinth flanges

Side and front/rear plinth flanges H=100mm RAL 7012.

Description	Dimensions (mm)		Order code	ABB code	Package/ No. pcs
	W	D			
Front/rear plinth flanges					
No.2 plinth flanges	300		PPFM1030	1STQ007050A0000	1/2
No.2 plinth flanges	400		PPFM1040	1STQ007051A0000	1/2
No.2 plinth flanges	600		PPFM1060	1STQ007053A0000	1/2
No.2 plinth flanges	800		PPFM1080	1STQ007055A0000	1/2
No.2 plinth flanges	1000		PPFM1010	1STQ007056A0000	1/2
No.4 plinth flanges	1250		PPFM1250	1STQ007057A0000	1/4
Side plinth flanges					
No.2 plinth flanges		200	PPFM1020	1STQ007058A0000	1/2
No.2 plinth flanges		300	PPFM1030	1STQ007050A0000	1/2
No.2 plinth flanges		500	PPFM1050	1STQ007052A0000	1/2
No.2 plinth flanges		700	PPFM1070	1STQ007059A0000	1/2
No.2 plinth flanges		900	PPFM1090	1STQ007060A0000	1/2

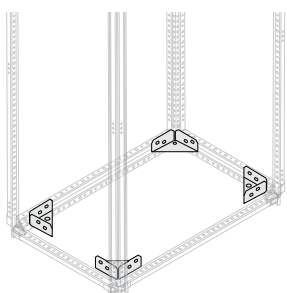

Brackets for bottoms without plinth

The kit allows the mounting of the angle pieces PPAM.... from the inside of the structure or the application of enclosures without plinth when combined with the proper internal bottom PBWP.... IP40 or the other bottom codes available that have to be cut according to the drilling indication in chapter 8.

Description	Order code	ABB code	Package/ No. pcs
No. 4 brackets for bottoms without plinth	PBRB0004	1STQ008127A0000	1/4

System pro E power

Order codes - External covers

2

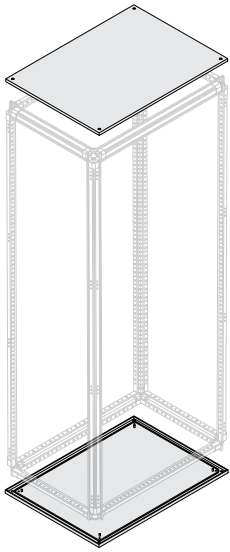

Blind Top/Bottom IP65 – Pickled sheet steel

Pickled sheet steel with IP65 gasket. The article comprises one single component that can be used as either a top or bottom. In order to purchase both the top and the bottom, please order two quantities of the same code or two different top/bottom codes according to the desired design of the structure. The code includes four M12x20 screws.

Description	Dimensions (mm)		Order code	ABB code	Package/ No. pcs
	W	D			
Blind Top/Bottom IP65	300	200	PTBB3026	1STQ007074A0000	1/1
Blind Top/Bottom IP65	300	300	PTBB3036	1STQ007075A0000	1/1
Blind Top/Bottom IP65	300	500	PTBB3056	1STQ007076A0000	1/1
Blind Top/Bottom IP65	300	700	PTBB3076	1STQ007077A0000	1/1
Blind Top/Bottom IP65	300	900	PTBB3096	1STQ007078A0000	1/1
Blind Top/Bottom IP65	400	200	PTBB4026	1STQ007079A0000	1/1
Blind Top/Bottom IP65	400	300	PTBB4036	1STQ007080A0000	1/1
Blind Top/Bottom IP65	400	500	PTBB4056	1STQ007081A0000	1/1
Blind Top/Bottom IP65	400	700	PTBB4076	1STQ007082A0000	1/1
Blind Top/Bottom IP65	400	900	PTBB4096	1STQ007083A0000	1/1
Blind Top/Bottom IP65	600	200	PTBB6026	1STQ007086A0000	1/1
Blind Top/Bottom IP65	600	300	PTBB6036	1STQ007087A0000	1/1
Blind Top/Bottom IP65	600	500	PTBB6056	1STQ007088A0000	1/1
Blind Top/Bottom IP65	600	700	PTBB6076	1STQ007089A0000	1/1
Blind Top/Bottom IP65	600	900	PTBB6096	1STQ007090A0000	1/1
Blind Top/Bottom IP65	800	200	PTBB8026	1STQ007094A0000	1/1
Blind Top/Bottom IP65	800	300	PTBB8036	1STQ007095A0000	1/1
Blind Top/Bottom IP65	800	500	PTBB8056	1STQ007096A0000	1/1
Blind Top/Bottom IP65	800	700	PTBB8076	1STQ007097A0000	1/1
Blind Top/Bottom IP65	800	900	PTBB8096	1STQ007098A0000	1/1
Blind Top/Bottom IP65	1000	200	PTBB1026	1STQ009178A0000	1/1
Blind Top/Bottom IP65	1000	300	PTBB1036	1STQ007099A0000	1/1
Blind Top/Bottom IP65	1000	500	PTBB1056	1STQ007100A0000	1/1
Blind Top/Bottom IP65	1000	700	PTBB1076	1STQ007101A0000	1/1
Blind Top/Bottom IP65	1000	900	PTBB1096	1STQ007102A0000	1/1

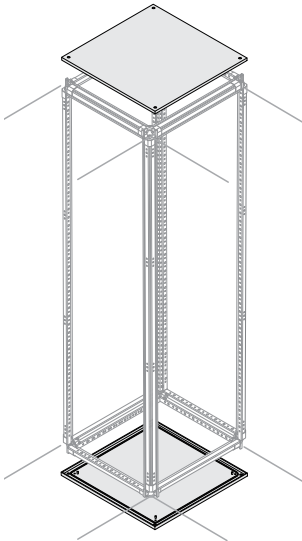

Top/bottom IP65 for corner structures

Pickled sheet steel with IP65 gasket. The article comprises one single component that can be used as either a top or bottom. In order to purchase both the top and the bottom, please order two quantities of the same code or two different top/bottom codes according to the desired design of the structure. It requires the use of the relating kit PSCS0579 in case of joining corner structures.

Description	Dimensions (mm)		Order code	ABB code	Package/ No. pcs
	W	D			
Blind Top/Bottom IP65	500	500	PTBB5050	1STQ009179A0000	1/1
Blind Top/Bottom IP65	700	700	PTBB7070	1STQ009180A0000	1/1
Blind Top/Bottom IP65	900	900	PTBB9090	1STQ009181A0000	1/1

To fix the busbars system use the universal crosspiece PCRM2013 that has to be cut according to the needs and the brackets PBCB0002.

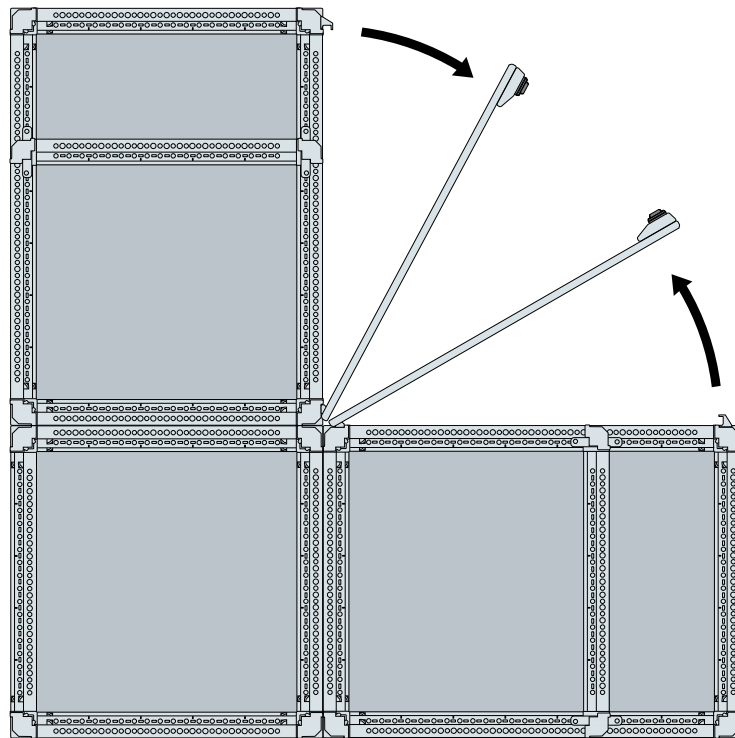

System pro E power

Order codes - External covers

2

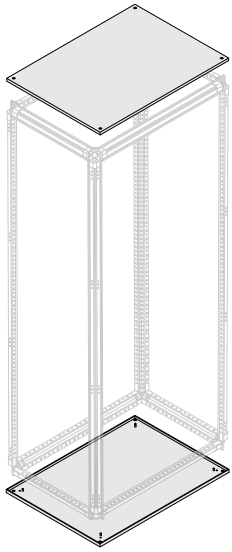

Blind Top/Bottom IP30, IP40 – Pickled sheet steel

Pickled sheet steel without gasket. In order to reach IPX1 protection degree it is necessary to add the proper top sealing kit, page 2/23.

The article comprises one single component that can be used as either a top or bottom. In order to purchase both the top and the bottom, please order two quantities of the same code or two different top/bottom codes according to the desired design of the structure. The code includes four M12x20 screws.

Description	Dimensions (mm)		Order code	ABB code	Package/ No. pcs
	W	D			
Blind Top/Bottom IP30, 40	300	200	PTBB3020	1STQ007107A0000	1/1
Blind Top/Bottom IP30, 40	300	300	PTBB3030	1STQ007108A0000	1/1
Blind Top/Bottom IP30, 40	300	500	PTBB3050	1STQ007109A0000	1/1
Blind Top/Bottom IP30, 40	300	700	PTBB3070	1STQ007110A0000	1/1
Blind Top/Bottom IP30, 40	300	900	PTBB3090	1STQ007111A0000	1/1
Blind Top/Bottom IP30, 40	400	200	PTBB4020	1STQ007112A0000	1/1
Blind Top/Bottom IP30, 40	400	300	PTBB4030	1STQ007113A0000	1/1
Blind Top/Bottom IP30, 40	400	500	PTBB4050	1STQ007114A0000	1/1
Blind Top/Bottom IP30, 40	400	700	PTBB4070	1STQ007115A0000	1/1
Blind Top/Bottom IP30, 40	400	900	PTBB4090	1STQ007116A0000	1/1
Blind Top/Bottom IP30, 40	600	200	PTBB6020	1STQ007117A0000	1/1
Blind Top/Bottom IP30, 40	600	300	PTBB6030	1STQ007118A0000	1/1
Blind Top/Bottom IP30, 40	600	500	PTBB6050	1STQ007119A0000	1/1
Blind Top/Bottom IP30, 40	600	700	PTBB6070	1STQ007120A0000	1/1
Blind Top/Bottom IP30, 40	600	900	PTBB6090	1STQ007121A0000	1/1
Blind Top/Bottom IP30, 40	800	200	PTBB8020	1STQ007122A0000	1/1
Blind Top/Bottom IP30, 40	800	300	PTBB8030	1STQ007123A0000	1/1
Blind Top/Bottom IP30, 40	800	500	PTBB8050	1STQ007124A0000	1/1
Blind Top/Bottom IP30, 40	800	700	PTBB8070	1STQ007125A0000	1/1
Blind Top/Bottom IP30, 40	800	900	PTBB8090	1STQ007126A0000	1/1
Blind Top/Bottom IP30, 40	1000	200	PTBB1020	1STQ009152A0000	1/1
Blind Top/Bottom IP30, 40	1000	300	PTBB1030	1STQ007127A0000	1/1
Blind Top/Bottom IP30, 40	1000	500	PTBB1050	1STQ007128A0000	1/1
Blind Top/Bottom IP30, 40	1000	700	PTBB1070	1STQ007129A0000	1/1
Blind Top/Bottom IP30, 40	1000	900	PTBB1090	1STQ007130A0000	1/1
Blind Top/Bottom IP30, 40	1250	200	PTBB1220	1STQ009153A0000	1/1
Blind Top/Bottom IP30, 40	1250	900	PTBB1290	1STQ007131A0000	1/1

Realization of the different IP protection class:

IP30: IP30, IP40 panels + vertical finishing profiles for structure or external cable container PPFV... or vertical finishing profiles for internal cable container PPCV... and horizontal finishing profiles PPFH...

IP31: add to IP30 codes the top sealing kit PKPT...

IP40: IP30, IP40 panels + blind door IP40/IP41 PDLB... or glass door IP40/IP41 PDLG...

IP41: add to IP40 codes the top sealing kit PKPT...

IP65: dedicated IP65 codes

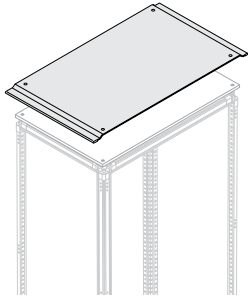

Top sealing kit IP31/IP41

Profiles for IP31/IP41 for top.

Description	Dimensions (mm)		Order code	ABB code	Package/ No. pcs
	W	D			
Top sealing kit IP31/IP41	300	200	PKPT3020	1STQ008061A0000	1/1
Top sealing kit IP31/IP41	300	300	PKPT3030	1STQ008062A0000	1/1
Top sealing kit IP31/IP41	300	500	PKPT3050	1STQ008063A0000	1/1
Top sealing kit IP31/IP41	300	700	PKPT3070	1STQ008064A0000	1/1
Top sealing kit IP31/IP41	300	900	PKPT3090	1STQ008065A0000	1/1
Top sealing kit IP31/IP41	400	200	PKPT4020	1STQ008066A0000	1/1
Top sealing kit IP31/IP41	400	300	PKPT4030	1STQ008067A0000	1/1
Top sealing kit IP31/IP41	400	500	PKPT4050	1STQ008068A0000	1/1
Top sealing kit IP31/IP41	400	700	PKPT4070	1STQ008069A0000	1/1
Top sealing kit IP31/IP41	400	900	PKPT4090	1STQ008070A0000	1/1
Top sealing kit IP31/IP41	600	200	PKPT6020	1STQ008071A0000	1/1
Top sealing kit IP31/IP41	600	300	PKPT6030	1STQ008072A0000	1/1
Top sealing kit IP31/IP41	600	500	PKPT6050	1STQ008073A0000	1/1
Top sealing kit IP31/IP41	600	700	PKPT6070	1STQ008074A0000	1/1
Top sealing kit IP31/IP41	600	900	PKPT6090	1STQ008075A0000	1/1
Top sealing kit IP31/IP41	800	200	PKPT8020	1STQ008076A0000	1/1
Top sealing kit IP31/IP41	800	300	PKPT8030	1STQ008077A0000	1/1
Top sealing kit IP31/IP41	800	500	PKPT8050	1STQ008078A0000	1/1
Top sealing kit IP31/IP41	800	700	PKPT8070	1STQ008079A0000	1/1
Top sealing kit IP31/IP41	800	900	PKPT8090	1STQ008080A0000	1/1
Top sealing kit IP31/IP41	1000	200	PKPT1020	1STQ009176A0000	1/1
Top sealing kit IP31/IP41	1000	300	PKPT1030	1STQ008081A0000	1/1
Top sealing kit IP31/IP41	1000	500	PKPT1050	1STQ008082A0000	1/1
Top sealing kit IP31/IP41	1000	700	PKPT1070	1STQ008083A0000	1/1
Top sealing kit IP31/IP41	1000	900	PKPT1090	1STQ008084A0000	1/1
Top sealing kit IP31/IP41	1250	200	PKPT1220	1STQ009177A0000	1/1
Top sealing kit IP31/IP41	1250	900	PKPT1259	1STQ008085A0000	1/1

System pro E power

Order codes - External covers

2

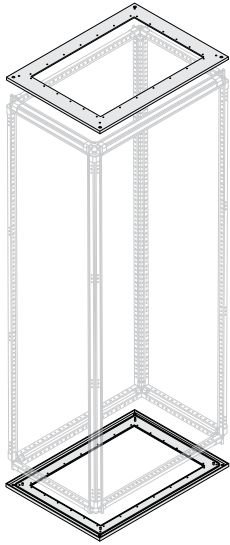

Open Top/Bottom

Pickled sheet steel with holes. The code comprises one single component that can be used as either a top or bottom. In order to purchase both the top and the bottom, please order two quantities of the same code or two different top/bottom codes according to the desired design of the structure.

In order to reach IP65 protection degree, use the dedicated fixed cable incoming flanges PFCF....; in order to reach IP40 protection degree, use the dedicated swinging cable incoming flanges PFCS.... at page 2/25.

The use of the single open top/bottom without flanges does not guarantee any degree of protection IP. The open top/bottom, associated with sliding flanges, is incompatible with crosspieces assembled inside the cable compartment.

Description	Dimensions (mm)		Order code	ABB code	Package/ No. pcs
	W	D			
Open Top/Bottom	300	200	PTBO3020	1STQ007135A0000	1/1
Open Top/Bottom	300	300	PTBO3030	1STQ007136A0000	1/1
Open Top/Bottom	300	500	PTBO3050	1STQ007137A0000	1/1
Open Top/Bottom	300	700	PTBO3070	1STQ007138A0000	1/1
Open Top/Bottom	300	900	PTBO3090	1STQ007139A0000	1/1
Open Top/Bottom	400	200	PTBO4020	1STQ007140A0000	1/1
Open Top/Bottom	400	300	PTBO4030	1STQ007141A0000	1/1
Open Top/Bottom	400	500	PTBO4050	1STQ007142A0000	1/1
Open Top/Bottom	400	700	PTBO4070	1STQ007143A0000	1/1
Open Top/Bottom	400	900	PTBO4090	1STQ007144A0000	1/1
Open Top/Bottom	600	200	PTBO6020	1STQ007147A0000	1/1
Open Top/Bottom	600	300	PTBO6030	1STQ007148A0000	1/1
Open Top/Bottom	600	500	PTBO6050	1STQ007149A0000	1/1
Open Top/Bottom	600	700	PTBO6070	1STQ007150A0000	1/1
Open Top/Bottom	600	900	PTBO6090	1STQ007151A0000	1/1
Open Top/Bottom	800	200	PTBO8020	1STQ007155A0000	1/1
Open Top/Bottom	800	300	PTBO8030	1STQ007156A0000	1/1
Open Top/Bottom	800	500	PTBO8050	1STQ007157A0000	1/1
Open Top/Bottom	800	700	PTBO8070	1STQ007158A0000	1/1
Open Top/Bottom	800	900	PTBO8090	1STQ007159A0000	1/1
Open Top/Bottom	1000	300	PTBO1030	1STQ007160A0000	1/1
Open Top/Bottom	1000	500	PTBO1050	1STQ007161A0000	1/1
Open Top/Bottom	1000	700	PTBO1070	1STQ007162A0000	1/1
Open Top/Bottom	1000	900	PTBO1090	1STQ007163A0000	1/1
Open Top/Bottom	1250	900	PTBO1290	1STQ007167A0000	1/1

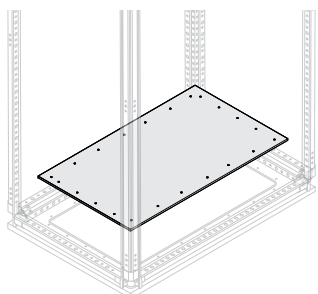

Fixed incoming cable flange

Fixed incoming cable flange in sheet metal to use in conjunction with the open bottom to guarantee IP65 protection class. With internal cable compartment crosspieces it is necessary to mount the fixed flange first.

Description	Dimensioni (mm)		Order code	ABB code	Package/ No. pcs
	W	D			
Fixed incoming cable flange	300	200	PFCF3020	1STQ007658A0000	1/1
Fixed incoming cable flange	300	300	PFCF3030	1STQ007659A0000	1/1
Fixed incoming cable flange	300	500	PFCF3050	1STQ007660A0000	1/1
Fixed incoming cable flange	300	700	PFCF3070	1STQ007661A0000	1/1
Fixed incoming cable flange	300	900	PFCF3090	1STQ007662A0000	1/1
Fixed incoming cable flange	400	200	PFCF4020	1STQ007663A0000	1/1
Fixed incoming cable flange	400	300	PFCF4030	1STQ007664A0000	1/1
Fixed incoming cable flange	400	500	PFCF4050	1STQ007665A0000	1/1
Fixed incoming cable flange	400	700	PFCF4070	1STQ007666A0000	1/1
Fixed incoming cable flange	400	900	PFCF4090	1STQ007667A0000	1/1
Fixed incoming cable flange	600	200	PFCF6020	1STQ007670A0000	1/1
Fixed incoming cable flange	600	300	PFCF6030	1STQ007671A0000	1/1
Fixed incoming cable flange	600	500	PFCF6050	1STQ007672A0000	1/1
Fixed incoming cable flange	600	700	PFCF6070	1STQ007673A0000	1/1
Fixed incoming cable flange	600	900	PFCF6090	1STQ007674A0000	1/1
Fixed incoming cable flange	800	200	PFCF8020	1STQ007678A0000	1/1
Fixed incoming cable flange	800	300	PFCF8030	1STQ007679A0000	1/1
Fixed incoming cable flange	800	500	PFCF8050	1STQ007680A0000	1/1
Fixed incoming cable flange	800	700	PFCF8070	1STQ007681A0000	1/1
Fixed incoming cable flange	800	900	PFCF8090	1STQ007682A0000	1/1
Fixed incoming cable flange	1000	300	PFCF1030	1STQ007683A0000	1/1
Fixed incoming cable flange	1000	500	PFCF1050	1STQ007684A0000	1/1
Fixed incoming cable flange	1000	700	PFCF1070	1STQ007685A0000	1/1
Fixed incoming cable flange	1000	900	PFCF1090	1STQ007686A0000	1/1
Fixed incoming cable flange	1250	900	2xPFCF6090	1STQ007674A0000	1/1

Sliding incoming cable flanges in sheet metal

Sliding incoming cable flanges in sheet metal to use in conjunction with the open bottom to guarantee IP40 protection class. It is not possible to assemble the sliding flanges in structures with internal cable compartment.

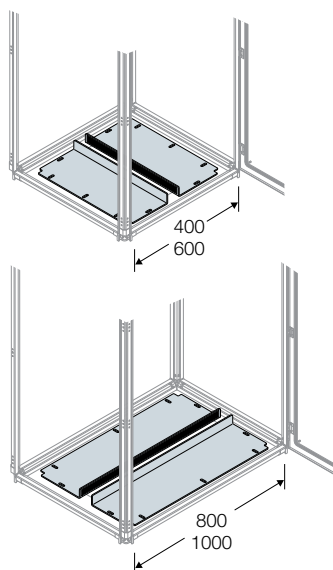

Description	Dimensioni (mm)		Order code	ABB code	Package/ No. pcs
	W	D			
No.2 sliding flanges	400	500	PFCS4050	1STQ007699A0000	1/2
No.2 sliding flanges	400	700	PFCS4070	1STQ007700A0000	1/2
No.2 sliding flanges	400	900	PFCS4090	1STQ007701A0000	1/2
No.2 sliding flanges	600	500	PFCS6050	1STQ007705A0000	1/2
No.2 sliding flanges	600	700	PFCS6070	1STQ007706A0000	1/2
No.2 sliding flanges	600	900	PFCS6090	1STQ007707A0000	1/2
No.2 sliding flanges	800	500	PFCS8050	1STQ007712A0000	1/2
No.2 sliding flanges	800	700	PFCS8070	1STQ007713A0000	1/2
No.2 sliding flanges	800	900	PFCS8090	1STQ007714A0000	1/2
No.2 sliding flanges	1000	500	PFCS1050	1STQ007716A0000	1/2
No.2 sliding flanges	1000	700	PFCS1070	1STQ007717A0000	1/2
No.2 sliding flanges	1000	900	PFCS1090	1STQ007718A0000	1/2
No.2 sliding flanges	1250	900	2xPFCS6090	1STQ007707A0000	1/2

System pro E power

Order codes - External covers

2

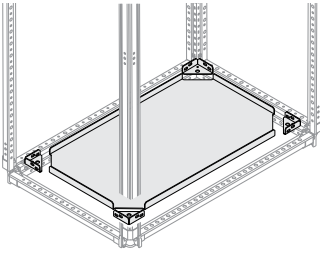

Internal bottom IP40

Internal galvanized steel bottom with special brackets kit included (special brackets kit available also as spare part with the code PBRB0004). In order to reach IPX1 protection degree it is necessary to add the proper top sealing kit PKPT..., page 2/23.

Description	Dimensions (mm)		Order code	ABB code	Package/ No. pcs
	W	D			
Internal bottom	300	200	PBWP3020	1STQ007171A0000	1/1
Internal bottom	300	300	PBWP3030	1STQ007172A0000	1/1
Internal bottom	300	500	PBWP3050	1STQ007173A0000	1/1
Internal bottom	300	700	PBWP3070	1STQ007174A0000	1/1
Internal bottom	300	900	PBWP3090	1STQ007175A0000	1/1
Internal bottom	400	200	PBWP4020	1STQ007176A0000	1/1
Internal bottom	400	300	PBWP4030	1STQ007177A0000	1/1
Internal bottom	400	500	PBWP4050	1STQ007178A0000	1/1
Internal bottom	400	700	PBWP4070	1STQ007179A0000	1/1
Internal bottom	400	900	PBWP4090	1STQ007180A0000	1/1
Internal bottom	600	200	PBWP6020	1STQ007183A0000	1/1
Internal bottom	600	300	PBWP6030	1STQ007184A0000	1/1
Internal bottom	600	500	PBWP6050	1STQ007185A0000	1/1
Internal bottom	600	700	PBWP6070	1STQ007186A0000	1/1
Internal bottom	600	900	PBWP6090	1STQ007187A0000	1/1
Internal bottom	800	200	PBWP8020	1STQ007191A0000	1/1
Internal bottom	800	300	PBWP8030	1STQ007192A0000	1/1
Internal bottom	800	500	PBWP8050	1STQ007193A0000	1/1
Internal bottom	800	700	PBWP8070	1STQ007194A0000	1/1
Internal bottom	800	900	PBWP8090	1STQ007195A0000	1/1
Internal bottom	1000	300	PBWP1030	1STQ007196A0000	1/1
Internal bottom	1000	500	PBWP1050	1STQ007197A0000	1/1
Internal bottom	1000	700	PBWP1070	1STQ007198A0000	1/1
Internal bottom	1000	900	PBWP1090	1STQ007199A0000	1/1
Internal bottom	1250	900	PBWP1290	1STQ007203A0000	1/1

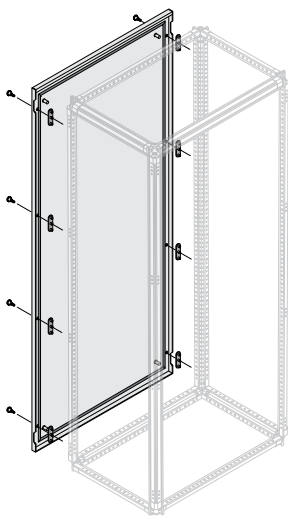

External blind rear panel IP65

Pickled sheet steel with gasket and plugs IP65.

Description	Dimensions (mm)		Order code	ABB code	Package/ No. pcs
	H	W			
Blind rear panel IP65	1800	300	PPEB1836	1STQ007577A0000	1/1
Blind rear panel IP65	1800	400	PPEB1846	1STQ007578A0000	1/1
Blind rear panel IP65	1800	600	PPEB1866	1STQ007580A0000	1/1
Blind rear panel IP65	1800	800	PPEB1886	1STQ007583A0000	1/1
Blind rear panel IP65	1800	1000	PPEB1816	1STQ007585A0000	1/1
Blind rear panel IP65	2000	300	PPEB2036	1STQ007589A0000	1/1
Blind rear panel IP65	2000	400	PPEB2046	1STQ007590A0000	1/1
Blind rear panel IP65	2000	600	PPEB2066	1STQ007592A0000	1/1
Blind rear panel IP65	2000	800	PPEB2086	1STQ007594A0000	1/1
Blind rear panel IP65	2000	1000	PPEB2016	1STQ007596A0000	1/1

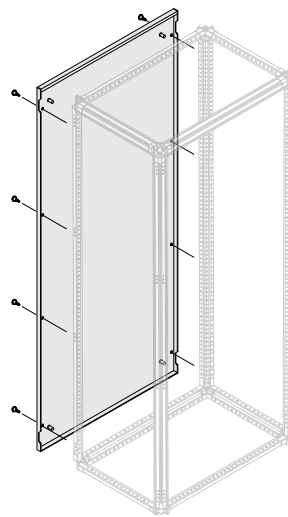

External blind rear panel IP30, IP40

Pickled sheet steel without gasket. In order to reach IPX1 protection degree it is necessary to add the proper top sealing kit PKPT..., page 2/23.

Description	Dimensions (mm)		Order code	ABB code	Package/ No. pcs
	H	W			
Blind rear panel IP30, IP40	1800	300	PPEB1830	1STQ007608A0000	1/1
Blind rear panel IP30, IP40	1800	400	PPEB1840	1STQ007609A0000	1/1
Blind rear panel IP30, IP40	1800	600	PPEB1860	1STQ007611A0000	1/1
Blind rear panel IP30, IP40	1800	800	PPEB1880	1STQ007613A0000	1/1
Blind rear panel IP30, IP40	1800	1000	PPEB1810	1STQ007615A0000	1/1
Blind rear panel IP30, IP40	1800	right	PPRB1820	1STQ007616A0000	1/1
Blind rear panel IP30, IP40		left	PPLB1820	1STQ007617A0000	1/1
Blind rear panel IP30, IP40	2000	300	PPEB2030	1STQ007619A0000	1/1
Blind rear panel IP30, IP40	2000	400	PPEB2040	1STQ007620A0000	1/1
Blind rear panel IP30, IP40	2000	600	PPEB2060	1STQ007622A0000	1/1
Blind rear panel IP30, IP40	2000	800	PPEB2080	1STQ007624A0000	1/1
Blind rear panel IP30, IP40	2000	1000	PPEB2010	1STQ007626A0000	1/1
Blind rear panel IP30, IP40	2000	right	PPRB2020	1STQ007627A0000	1/1
Blind rear panel IP30, IP40		left	PPLB2020	1STQ007628A0000	1/1

Realization of the different IP protection class:

IP30: IP30, IP40 panels + vertical finishing profiles for structure or external cable container PPFV... or vertical finishing profiles for internal cable container PPCV... and horizontal finishing profiles PPFH...

IP31: add to IP30 codes the top sealing kit PKPT...

IP40: IP30, IP40 panels + blind door IP40/IP41 PDLB... or glass door IP40/IP41 PDLG...

IP41: add to IP40 codes the top sealing kit PKPT...

IP65: dedicated IP65 codes

System pro E power

Order codes - External covers

2

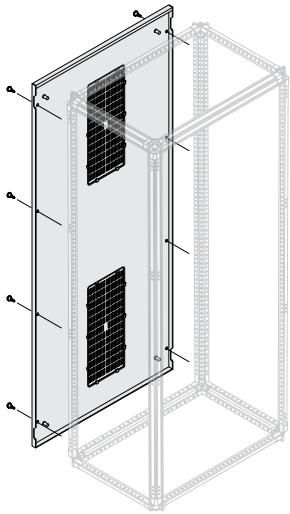

External vented rear panel IP30

In order to reach IPX1 protection degree it is necessary to add the proper top sealing kit PKPT..., page 2/23.

Description	No. Vented grates	Dimensions (mm)		Order code	ABB code	Package/ No. pcs
		H	W			
Vented rear panel IP30	2	1800	300	PPEA1830	1STQ007630A0000	1/1
Vented rear panel IP30	2	1800	400	PPEA1840	1STQ007631A0000	1/1
Vented rear panel IP30	2	1800	600	PPEA1860	1STQ007633A0000	1/1
Vented rear panel IP30	4	1800	800	PPEA1880	1STQ007636A0000	1/1
Vented rear panel IP30	6	1800	1000	PPEA1810	1STQ007638A0000	1/1
Vented rear panel IP30/31 with gasket	right	6	1800	PPRA1820	1STQ007639A0000	1/1
	left			PPLA1820	1STQ007640A0000	1/1
Vented rear panel IP30	2	2000	300	PPEA2030	1STQ007641A0000	1/1
Vented rear panel IP30	2	2000	400	PPEA2040	1STQ007642A0000	1/1
Vented rear panel IP30	2	2000	600	PPEA2060	1STQ007644A0000	1/1
Vented rear panel IP30	4	2000	800	PPEA2080	1STQ007646A0000	1/1
Vented rear panel IP30	6	2000	1000	PPEA2010	1STQ007648A0000	1/1
Vented rear panel IP30 with gasket	right	4	2000	PPRA2020	1STQ007649A0000	1/1
	left			PPLA2020	1STQ007650A0000	1/1

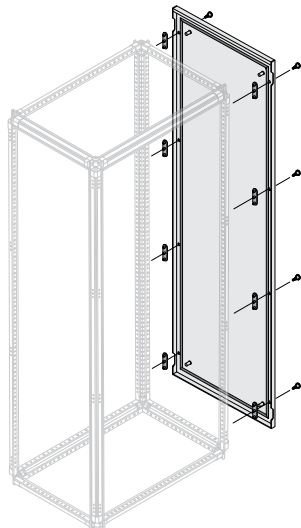

External blind side panel IP65

Pickled sheet steel with gasket and plugs IP65. The code refers to one single side panel.

Description	Dimensions (mm)		Order code	ABB code	Package/ No. pcs
	H	D			
Blind side panel IP65	1800	200	PPEB1826	1STQ007575A0000	1/1
Blind side panel IP65	1800	300	PPEB1836	1STQ007577A0000	1/1
Blind side panel IP65	1800	500	PPEB1856	1STQ007579A0000	1/1
Blind side panel IP65	1800	700	PPEB1876	1STQ007581A0000	1/1
Blind side panel IP65	1800	900	PPEB1896	1STQ007584A0000	1/1
Blind side panel IP65	2000	200	PPEB2026	1STQ007588A0000	1/1
Blind side panel IP65	2000	300	PPEB2036	1STQ007589A0000	1/1
Blind side panel IP65	2000	500	PPEB2056	1STQ008106A0000	1/1
Blind side panel IP65	2000	700	PPEB2076	1STQ008107A0000	1/1
Blind side panel IP65	2000	900	PPEB2096	1STQ008108A0000	1/1

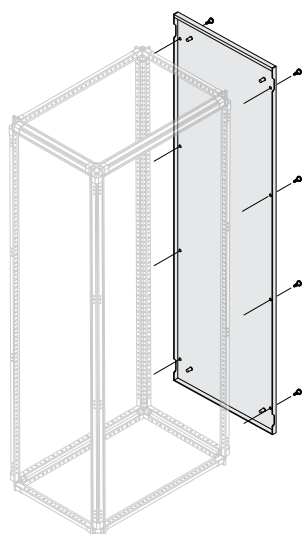

External blind side panel IP30, IP40

Pickled sheet steel with gasket. The code refers to one single side panel. In order to reach IPX1 protection degree it is necessary to add the proper top sealing kit PKPT..., page 2/23.

Description	Dimensions (mm)		Order code	ABB code	Package/ No. pcs
	H	D			
Blind side panel IP30, IP40	1800	200	PPEB1820	1STQ007607A0000	1/1
Blind side panel IP30, IP40	1800	300	PPEB1830	1STQ007608A0000	1/1
Blind side panel IP30, IP40	1800	500	PPEB1850	1STQ007610A0000	1/1
Blind side panel IP30, IP40	1800	700	PPEB1870	1STQ007612A0000	1/1
Blind side panel IP30, IP40	1800	900	PPEB1890	1STQ007614A0000	1/1
Blind side panel IP30, IP40	2000	200	PPEB2020	1STQ007618A0000	1/1
Blind side panel IP30, IP40	2000	300	PPEB2030	1STQ007619A0000	1/1
Blind side panel IP30, IP40	2000	500	PPEB2050	1STQ007621A0000	1/1
Blind side panel IP30, IP40	2000	700	PPEB2070	1STQ007623A0000	1/1
Blind side panel IP30, IP40	2000	900	PPEB2090	1STQ007625A0000	1/1

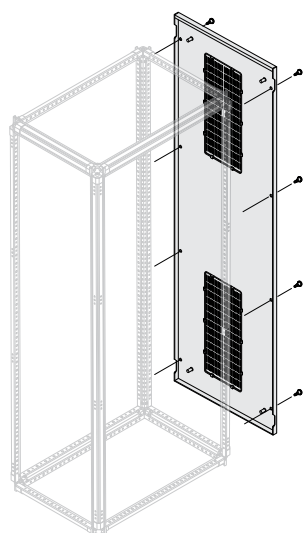

External vented side panel IP30

Pickled sheet steel without gasket. The code refers to one single side panel. For IP40 order the dedicated grate PGPP0040. In order to reach IPX1 protection degree it is necessary to add the proper top sealing kit PKPT..., page 2/23.

Description	No. Vented grates	Dimensions (mm)		Order code	ABB code	Package/ No. pcs
		H	D			
Vented side panel IP30	2	1800	300	PPEA1830	1STQ007630A0000	1/1
Vented side panel IP30	2	1800	500	PPEA1850	1STQ007632A0000	1/1
Vented side panel IP30	2	1800	700	PPEA1870	1STQ007634A0000	1/1
Vented side panel IP30	4	1800	900	PPEA1890	1STQ007637A0000	1/1
Vented side panel IP30	2	2000	300	PPEA2030	1STQ007641A0000	1/1
Vented side panel IP30	2	2000	500	PPEA2050	1STQ007643A0000	1/1
Vented side panel IP30	2	2000	700	PPEA2070	1STQ007645A0000	1/1
Vented side panel IP30	4	2000	900	PPEA2090	1STQ007647A0000	1/1

Realization of the different IP protection class:

IP30: IP30, IP40 panels + vertical finishing profiles for structure or external cable container PPFV... or vertical finishing profiles for internal cable container PPCV... and horizontal finishing profiles PPFH....

IP31: add to IP30 codes the top sealing kit PKPT....

IP40: IP30, IP40 panels + blind door IP40/IP41 PDLB.... or glass door IP40/IP41 PDLG....

IP41: add to IP40 codes the top sealing kit PKPT....

IP65: dedicated IP65 codes

IP40 grate for Vented external panels

Accessory for Vented panels. Allows IP40 protection class to be obtained. Order the quantity on the basis of the number of grates on the panel. In order to reach IPX1 protection degree it is necessary to add the proper top sealing kit, page 2/23.

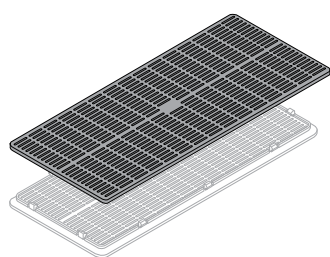

Description	Order code	ABB code	Package/ No. pcs
No.2 IP40 grates for Vented panels	PGPP0040	1STQ008090A0000	1/2

System pro E power

Order codes - External covers

2

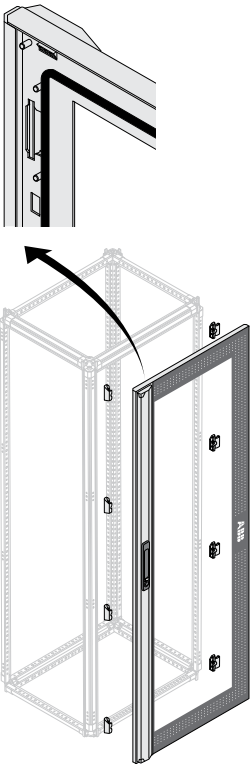

Glass door IP65

Pickled sheet steel with gasket. Opens through 135° (single column). Complete with 4 hinges to be screwed onto the uprights, 4 door closing brackets with cover and handle. Handle and hinges provided (not pre-assembled for complete reversibility). Doors can be mounted both on the front and on the back of the enclosures.

Description	No. DIN modules	Dimensions (mm)			Order code	ABB code	Package/ No. pcs
		H	W	Cable compartment W			
Glass door							
Glass door IP65	12	1800	400		PDLG1846	1STQ007303A0000	1/1
Glass door IP65	24	1800	600		PDLG1866	1STQ007305A0000	1/1
Glass door IP65	36	1800	800		PDLG1886	1STQ007308A0000	1/1
Glass door IP65	48	1800	1000		PDLG1816	1STQ007311A0000	1/1
Glass door IP65	12	2000	400		PDLG2046	1STQ007314A0000	1/1
Glass door IP65	24	2000	600		PDLG2066	1STQ007316A0000	1/1
Glass door IP65	36	2000	800		PDLG2086	1STQ007319A0000	1/1
Glass door IP65	48	2000	1000		PDLG2016	1STQ007322A0000	1/1
Glass door for structures with internal cable compartment							
Glass door IP65	12	1800	600	200	PDLG1842	1STQ007304A0000	1/1
Glass door IP65	12	1800	800	400	PDLG1844	1STQ007306A0000	1/1
Glass door IP65	24	1800	800	200	PDLG1862	1STQ007307A0000	1/1
Glass door IP65	24	1800	1000	400	PDLG1864	1STQ007309A0000	1/1
Glass door IP65	36	1800	1000	200	PDLG1882	1STQ007310A0000	1/1
Glass door IP65	12	2000	600	200	PDLG2042	1STQ007315A0000	1/1
Glass door IP65	12	2000	800	400	PDLG2044	1STQ007317A0000	1/1
Glass door IP65	24	2000	800	200	PDLG2062	1STQ007318A0000	1/1
Glass door IP65	24	2000	1000	400	PDLG2064	1STQ007320A0000	1/1
Glass door IP65	36	2000	1000	200	PDLG2082	1STQ007321A0000	1/1

Glass door IP40

Pickled sheet steel without gasket and 4 rubber overlapping plugs. Opens through 135° (single column). Complete with 4 hinges to be screwed onto the uprights, 4 door closing brackets with cover and handle. Handle and hinges provided (not pre-assembled for complete reversibility). In order to reach IPX1 protection degree it is necessary to add the proper top sealing kit PKPT..., page 2/23. Doors can be mounted both on the front and on the back of the enclosures.

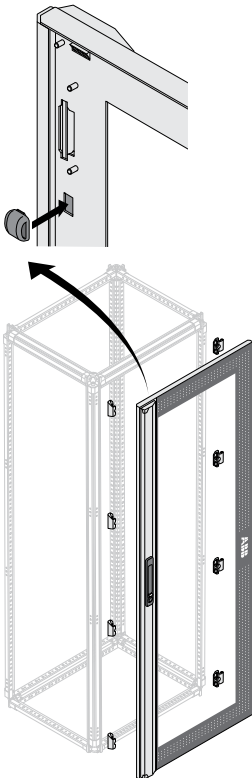

Description	No. DIN modules	Dimensions (mm)			Order code	ABB code	Package/ No. pcs
		H	W	Cable compartment W			
Glass door							
Glass door IP40	12	1800	400		PDLG1840	1STQ007325A0000	1/1
Glass door IP40	24	1800	600		PDLG1860	1STQ007327A0000	1/1
Glass door IP40	36	1800	800		PDLG1880	1STQ007330A0000	1/1
Glass door IP40	48	1800	1000		PDLG1810	1STQ007333A0000	1/1
Glass door IP40	12	2000	400		PDLG2040	1STQ007336A0000	1/1
Glass door IP40	24	2000	600		PDLG2060	1STQ007338A0000	1/1
Glass door IP40	36	2000	800		PDLG2080	1STQ007341A0000	1/1
Glass door IP40	48	2000	1000		PDLG2010	1STQ007344A0000	1/1
Glass door for structures with internal cable compartment							
Glass door IP40	12	1800	600	200	PDLG8420	1STQ007326A0000	1/1
Glass door IP40	12	1800	800	400	PDLG8440	1STQ007328A0000	1/1
Glass door IP40	24	1800	800	200	PDLG8620	1STQ007329A0000	1/1
Glass door IP40	24	1800	1000	400	PDLG8640	1STQ007331A0000	1/1
Glass door IP40	36	1800	1000	200	PDLG8820	1STQ007332A0000	1/1
Glass door IP40	12	2000	600	200	PDLG2420	1STQ007337A0000	1/1
Glass door IP40	12	2000	800	400	PDLG2440	1STQ007339A0000	1/1
Glass door IP40	24	2000	800	200	PDLG2620	1STQ007340A0000	1/1
Glass door IP40	24	2000	1000	400	PDLG2640	1STQ007342A0000	1/1
Glass door IP40	36	2000	1000	200	PDLG2820	1STQ007343A0000	1/1

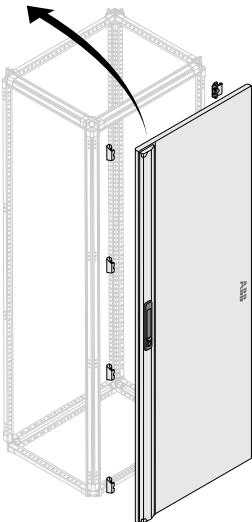
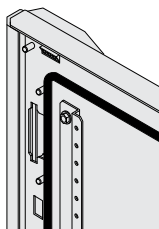

Blind door IP65

Pickled sheet steel with gasket. Opens through 135° (single column). Complete with 4 hinges to be screwed onto the uprights, 4 door closing brackets with cover and handle. Handle and hinges provided (not pre-assembled for complete reversibility). Doors can be mounted both on the front and on the back of the enclosures. Reinforcing tubes for W>400mm

Description	No. DIN modules	Dimensions (mm)		Order code	ABB code	Package/ No. pcs
		H	W			
Blind door IP65 cable compartment	-	1800	300	PDLB1836	1STQ007347A0000	1/1
Blind door IP65	12	1800	400	PDLB1846	1STQ007348A0000	1/1
Blind door IP65	24	1800	600	PDLB1866	1STQ007349A0000	1/1
Blind door IP65	36	1800	800	PDLB1886	1STQ007350A0000	1/1
Blind door IP65	48	1800	1000	PDLB1816	1STQ007351A0000	1/1
Blind door IP65 cable compartment	-	2000	300	PDLB2036	1STQ007354A0000	1/1
Blind door IP65	12	2000	400	PDLB2046	1STQ007355A0000	1/1
Blind door IP65	24	2000	600	PDLB2066	1STQ007356A0000	1/1
Blind door IP65	36	2000	800	PDLB2086	1STQ007357A0000	1/1
Blind door IP65	48	2000	1000	PDLB2016	1STQ007358A0000	1/1

Blind door IP40

Pickled sheet steel without gasket and 4 rubber overlapping plugs. Opens through 135° (single column). Complete with 4 hinges to be screwed onto the uprights, 4 door closing brackets with cover and handle. Handle and hinges provided (not pre-assembled for complete reversibility). In order to reach IPX1 protection degree it is necessary to add the proper top sealing kit PKPT..., page 2/23. Doors can be mounted both on the front and on the back of the enclosures. Reinforcing tubes for W>400mm

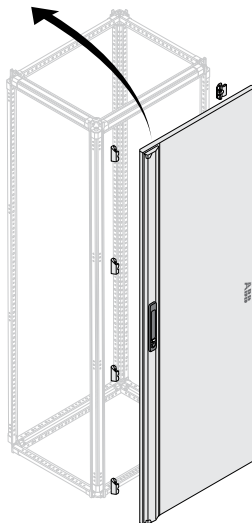
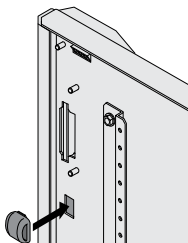

Description	No. DIN modules	Dimensions (mm)		Order code	ABB code	Package/ No. pcs
		H	W			
Blind door IP40 cable compartment	-	1800	300	PDLB1830	1STQ007361A0000	1/1
Blind door IP40	12	1800	400	PDLB1840	1STQ007362A0000	1/1
Blind door IP40	24	1800	600	PDLB1860	1STQ007363A0000	1/1
Blind door IP40	36	1800	800	PDLB1880	1STQ007364A0000	1/1
Blind door IP40	48	1800	1000	PDLB1810	1STQ007365A0000	1/1
Blind door IP40 cable compartment	-	2000	300	PDLB2030	1STQ007368A0000	1/1
Blind door IP40	12	2000	400	PDLB2040	1STQ007369A0000	1/1
Blind door IP40	24	2000	600	PDLB2060	1STQ007370A0000	1/1
Blind door IP40	36	2000	800	PDLB2080	1STQ007371A0000	1/1
Blind door IP40	48	2000	1000	PDLB2010	1STQ007372A0000	1/1

System pro E power

Order codes - External covers

2

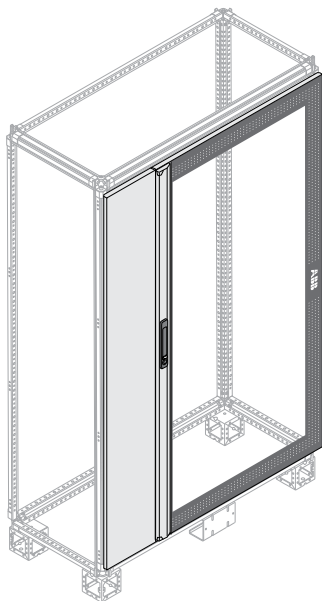

Double doors IP40 for W=1250mm structures

Doors with overlapping to use with the door with handle to create switchboards with double doors. Handle and hinges provided (not pre-assembled for complete reversibility). Doors can be mounted both on the front and on the back of the enclosures. In order to reach IPX1 protection degree it is necessary to add the proper top sealing kit, page 2/23.

Description	Dimensions (mm)		Order code	ABB code	Package/ No. pcs
	H	W			
Door with overlapping					
Blind door with overlapping IP40	1800	250	PDLB8120	1STQ007366A0000	1/1
Blind door with overlapping IP40	2000	250	PDLB2120	1STQ007373A0000	1/1
Door with handle					
Glass door with handle IP40	1800	1000	PDLG8500	1STQ007335A0000	1/1
Glass door with handle IP40	2000	1000	PDLG2500	1STQ007346A0000	1/1
Blind door with handle IP40	1800	1000	PDLB8500	1STQ007367A0000	1/1
Blind door with handle IP40	2000	1000	PDLB2500	1STQ007374A0000	1/1

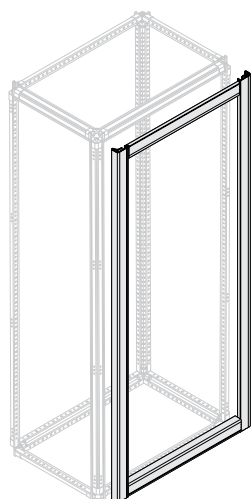

Horizontal/vertical front closing profiles IP30

Profiles for IP30/IP31 pickled sheet painted RAL 7035. In order to reach IPX1 protection degree it is necessary to add the proper top sealing kit PKPT..., page 2/23.

Description	Dimensions (mm)		Order code	ABB code	Package/ No. pcs
	H	W			
Finishing profiles vertical structure and external cable compartment					
No.2 vertical profiles IP30	1800		PPFV1800	1STQ008059A0000	1/2
No.2 vertical profiles IP30	2000		PPFV2000	1STQ008060A0000	1/2
Finishing profile vertical internal cable compartment					
No.1 profile vertical IP30	1800		PPCV1800	1STQ009294A0000	1/1
No.1 profile vertical IP30	2000		PPCV2000	1STQ009295A0000	1/1
Finishing profiles horizontal structure and external cable compartment					
No.2 horizontal profiles IP30		300	PPFH0300	1STQ008053A0000	1/2
No.2 horizontal profiles IP30		400	PPFH0400	1STQ008054A0000	1/2
No.2 horizontal profiles IP30		600	PPFH0600	1STQ008055A0000	1/2
No.2 horizontal profiles IP30		800	PPFH0800	1STQ008056A0000	1/2
No.2 horizontal profiles IP30		1000	PPFH1000	1STQ008057A0000	1/2
No.2 horizontal profiles IP30		1250	PPFH1250	1STQ008058A0000	1/2

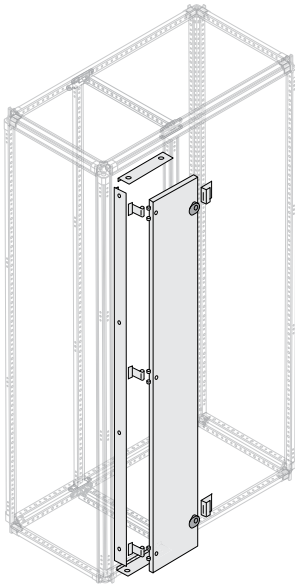

Internal door for internal cable compartment

Internal door in pickled steel sheet for cable compartment IP30.

Description	Dimensions (mm)		Order code	ABB code	Package/ No. pcs
	H	W			
Blind door for internal cable compartment	1800	200	PDCB1820	1STQ007753A0000	1/1
Blind door for internal cable compartment	1800	400	PDCB1840	1STQ007754A0000	1/1
Blind door for internal cable compartment	2000	200	PDCB2020	1STQ007755A0000	1/1
Blind door for internal cable compartment	2000	400	PDCB2040	1STQ007756A0000	1/1

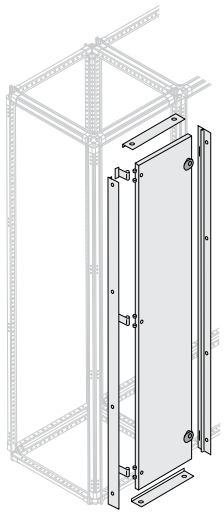

External door for external cable compartment

Internal door in pickled steel sheet for cable compartment IP30.

Description	Dimensions (mm)		Order code	ABB code	Package/ No. pcs
	H	W			
Blind door for external cable compartment	1800	300	PDCB1830	1STQ008086A0000	1/1
Blind door for external cable compartment	1800	400	PDCB1844	1STQ008087A0000	1/1
Blind door for external cable compartment	2000	300	PDCB2030	1STQ008088A0000	1/1
Blind door for external cable compartment	2000	400	PDCB2044	1STQ008089A0000	1/1

System pro E power

Order codes - Structure finishing components

2

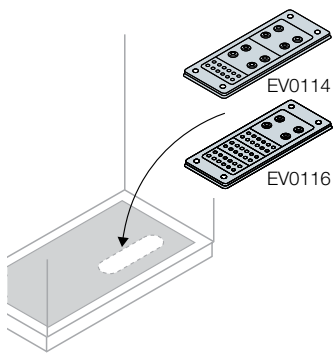

Pre-configured plastic cable gland flanges IP65

Allow numerous cables to be installed and guarantee that the components inside the switchboards are protected. The inserts have a membrane through which the cable can be easily pushed without the need for tools. IP65 protection class is guaranteed over the entire flange regardless of the number of cables installed. Cable clamp, and cable gland with cable clamp can also be installed.

RAL 7035 grey colour; operating temperature from -20 °C to +125 °C, IP65 protection class in accordance with EN 60529 specifications.

Description	Dimensioni (mm)		Order code	ABB code	Package/ No. pcs
	W	D			
Pre-configured modular flange IP65					
No.1 pre-configured incoming cable flange for 18 cables (Ø min/max 8/14mm) and 10 cables (Ø min/max 4/10mm)	214	90	EV0114	1STQ006545A0000	1/1
No.1 pre-configured incoming cable flange for 30 cables (Ø min/max 4/10mm), 2 cables (M20 Ø min/max 7/13mm) and 2 cables (M25 Ø min/max 8/17mm)	214	90	EV0116	1STQ006546A0000	1/1

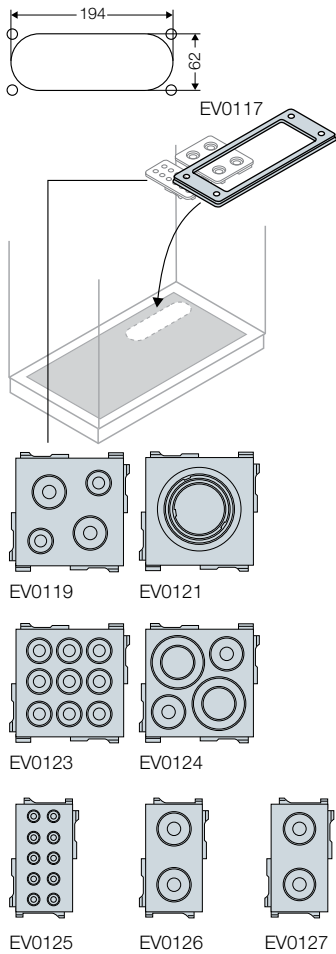

Flanges with adaptable plastic cable gland inserts IP65

Thanks to the frame and inserts available, the flange can be adapted to suit the size, quantity and position of the cables installed. The inserts have a membrane through which the cable can be easily pushed without the need for tools. IP65 protection class is guaranteed over the entire flange regardless of the number of cables installed. Cable clamp, and cable gland with cable clamp can also be installed. RAL 7035 grey colour; operating temperature from -20 °C to +125 °C, IP65 protection class in accordance with EN 60529 specifications.

Description	Dimensioni (mm)		Order code	ABB code	Package/ No. pcs
	W	D			
Adaptable modular flanges					
No. 1 flange frame for incoming cables to create with individual inserts	214	90	EV0117	1STQ006547A0000	1/1
Inserts for adaptable flanges					
No. 10 (ten) 68x68mm inserts for 4 incoming cables, 2 cables (M25 Ø min/ max 8/17mm), 2 cables (M16 Ø min/max 5/10mm)	68	68	EV0119	1STQ006548A0000	1/1
No. 10 (ten) 68x68mm inserts for 1 incoming cable type M32 / M40 / M50	68	68	EV0121	1STQ006549A0000	1/1
No. 10 (ten) 68x68mm inserts for 9 incoming cables (Ø min/max 8/14mm)	68	68	EV0123	1STQ006550A0000	1/1
No. 10 (ten) 68x68mm inserts for 4 incoming cables, 2 (Ø min/max 10/20) and 2 (Ø min/max 20/30mm)	68	68	EV0124	1STQ006551A0000	1/1
No. 10 (ten) 34x68mm inserts for 2 incoming cables (Ø min/max 8/17mm)	34	68	EV0125	1STQ006552A0000	1/1
No. 10 (ten) 34x68mm inserts for 2 incoming cables (Ø min/max 7/13mm)	34	68	EV0126	1STQ006553A0000	1/1
No. 10 (ten) 34x68mm inserts for 10 incoming cables (Ø min/max 4/10mm)	34	68	EV0127	1STQ006554A0000	1/1

System pro E power

Order codes - Accessories and spare parts

2

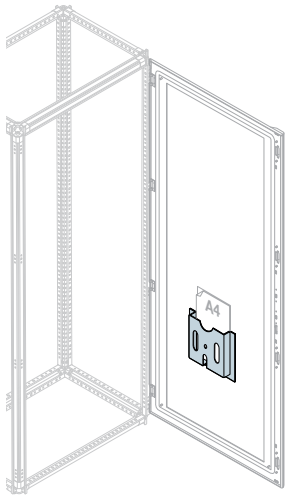

Plastic pocket for documents

Complete with adhesive parts for fixing to the door.

Description	Order code	ABB code	Package/ No. pcs
Plastic pocket for A4 documents	EV1075K	1STQ008199A0000	1/1

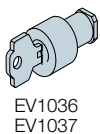
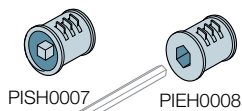
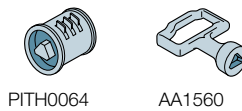
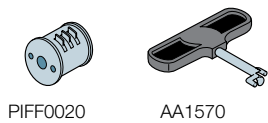
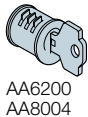
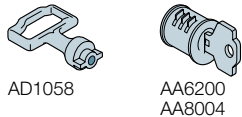
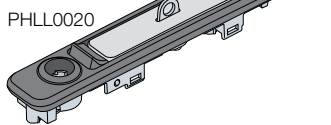
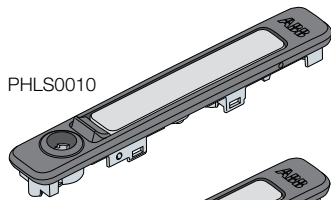

Closing systems

Can replace the standard closing systems of the external doors. The inserts are interchangeable and can be easily replaced by loosening just one nut.

Description	Order code	ABB code	Package/ No. pcs
Handle			
Standard lever handle (spare)	PHLS0010	1STQ008126A0000	1/1
Padlockable lever handle (spare)	PHLL0020	1STQ008128A0000	1/1

Description	Order code	ABB code	Package/ No. pcs
Inserts			
Yale insert+key for external door, single door version	AA6200	1STQ009135A0000	1/1
E739 ronis insert+key for external door, single door version	AA8004	1STQ009136A0000	1/1
FIAT type insert for lever handle	PIFH0020	1STQ008122A0000	1/1
FIAT key	AA1570	1STQ009137A0000	1/1
6.4 triangular male insert on Ø 7.6 for external door, single door version	PITH0064	1STQ008119A0000	1/1
Key for triangular insert	AA1560	1STQ009138A0000	1/1
7 square male insert for external door, single door version	PISH0007	1STQ008120A0000	1/1
Insert 8mm hex socket type for standard handle (Key not available)	PIEH0008	1STQ008121A0000	1/1
Double tab insert for closing handle/box	PIDH0010	1STQ008118A0000	1/1
Key zama for double tab insert	AD1058	1STQ009134A0000	1/1
Box with double tab insert in plastic with key for inner door (Nema TYPE 12)	EV1008	1STQ000956A0000	1/1
One-code Yale insert for inner door	EV1036	1STQ000974A0000	1/1
Ronis 405 insert and key for standard handle	PIRH0405	1STQ008123A0000	1/1
Ronis 455 insert for EV1008	EV1037	1STQ000975A0000	1/1

Description	Order code	ABB code	Package/ No. pcs
Key			
Ronis 455 insert and key for standard handle	PIRH0455	1STQ008124A0000	1/1
Ronis 1242 insert and key for standard handle	PIRH1242	1STQ008125A0000	1/1
3mm double tab insert for inner door	EV1039	1STQ000976A0000	1/1

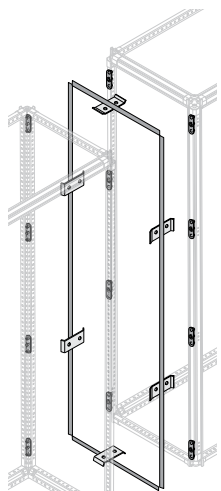

Kit for joining structures

The kit for joining structures is composed of different brackets and a gasket for the maintenance of the IP protection degree and allows both a side-by-side and a back-to-back joining of structures.

Description	Order code	ABB code	Package/ No. pcs
Kit for joining structures side by side / back to back	PSBS0065	1STQ008113A0000	1/1
Kit for joining corner structures	PSCS0579	1STQ009185A0000	1/1

Eyebolts for lifting

Allow wired switchboards to be lifted. Made of steel treated with a white passivated galvanizing process.

Description	Order code	ABB code	Package/ No. pcs
No.4 steel M12 eyebolts	PEBL0004	1STQ008112A0000	1/4

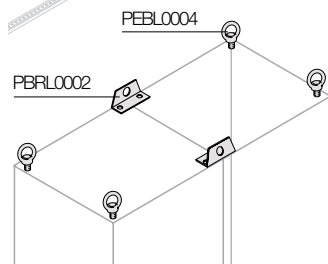

Lifting reinforcements

Used for handling several adjacent switchboards.

Description	Order code	ABB code	Package/ No. pcs
No.2 lifting reinforcements for adjacent switchboards	PBRL0002	1STQ008116A0000	1/2

Wall-mounting brackets

Allow the switchboards to be fixed to a wall

Description	Order code	ABB code	Package/ No. pcs
No.2 wall-mounting brackets	PBWF0002	1STQ008115A0000	1/2

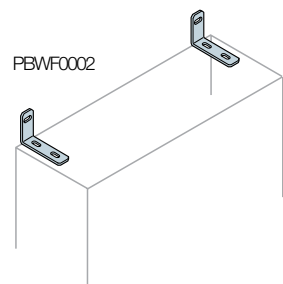

Screws

Description	Order code	ABB code	Package/ No. pcs
No.1000 self-perforating 4.2x13mm cross-head screws	EV1100	1STQ001005A0000	1/1000
No.1000 self-perforating 4.2x19mm cross-head screws	EV1101	1STQ001006A0000	1/1000
No.24 screws for side/rear panels	PSCP0024	1STQ009182A0000	1/24
No.24 screws 1/4 turn with washers	PCSS0024	1STQ009183A0000	1/24
No.20 M5 Torx screws and nylon washers L=16mm	EV0103	1STQ006608A0000	1/20
No.20 M6 Torx screws and nylon washers L=16mm	EV0104	1STQ006609A0000	1/20

Spray paints

RAL7035 colour spray paint for structures	VB7035	1STQ008129A0000	1/1
RAL7012 colour spray paint for plinths	VB7012	1STQ001064A0000	1/1

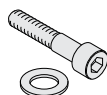

Axial screws for uprights

Axial screws for 3 way joint uprights.

Description	Order code	ABB code	Package/ No. pcs
No.16 axial screws for uprights	PSAF0016	1STQ008110A0000	1/16

Hinges for standard doors

Description	Order code	ABB code	Package/ No. pcs
No.4 hinges for standard door	PHDR0004	1STQ009159A0000	1/4
No.4 180° opening hinges	PHFR4180	1STQ009158A0000	1/4

System pro E power

Internal kits

General information

Kits for Emax 2 air circuit-breakers	3/2
Kits for Tmax XT and Tmax T moulded-case circuit-breakers	3/3
Kits for System Pro M e modular circuit-breakers	
XT1 and XT3 moulded-case circuit-breakers	3/3
Kits for OT switch-disconnectors	3/3

Quick selection guides

Recommended installation solutions	3/4
Kits for moulded-case circuit-breakers	3/10
Kits for air circuit-breakers	3/18

Guide to the order codes

3/19

Order codes

Internal kits	3/20
Accessories and spare parts	3/40

System pro E power

General information

The switchboards can be assembled very quickly even when extremely complex apparatus is involved thanks to the innovative internal kits designed for System pro E power. They match perfectly with the new uprights and crosspieces with double fixing levels and are available for air and moulded-case circuit-breakers, switch-disconnectors, modular circuit-breakers and internal segregation partitions.

The main advantages are:

- Quick click-in fixing system with ¼ turn screws
- Common kits for 3- and 4-pole moulded-case circuit-breakers installed horizontally
- Same front panels for fixed and swing frames, and for screwed and hinged solutions
- Two front panel height sizes available (150 and 200mm) for DIN rail kits.

Simple, effective systems for fixing the kits save time when the switchboards are assembled.

Kits for Emax 2 air circuit-breakers

Available for all sizes from E1.2 to E6.2 in fixed and withdrawable versions. Sturdy and simple, they meet the requirements of all applications, from 630 to 6300A.



Kits for Tmax XT and Tmax T moulded-case circuit-breakers

Available for XT1 to XT4 and T4 to T7 circuit-breakers. The major innovations include the common kit for 3- and 4-pole circuit-breakers installed horizontally and the 150mm height panel, which allows more circuit-breakers to be installed in the same unit than the 200mm panel solution.

Kits for System Pro M and XT1 and XT2 moulded-case circuit-breakers

Available for all modular circuit-breakers and for XT1 and XT2 moulded-case circuit-breakers. The DIN rail provides two pre-engineered assembly positions, corresponding to the depth of System pro M and Tmax XT circuit-breakers, respectively. The 150mm height panel also allows more circuit-breakers to be installed in the same unit than the 200mm panel solution.

Kits for OT switch-disconnectors

Available for OT up to 1600 A both in the vertical and horizontal versions.

Quick click-in fixing system with ¼ turn screws

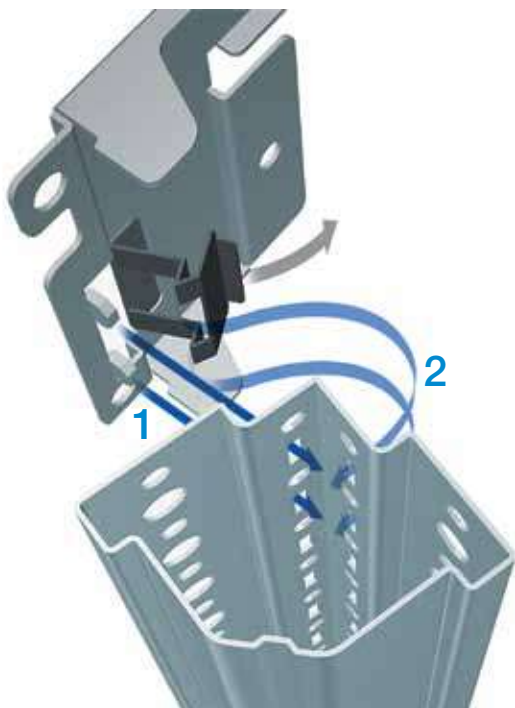
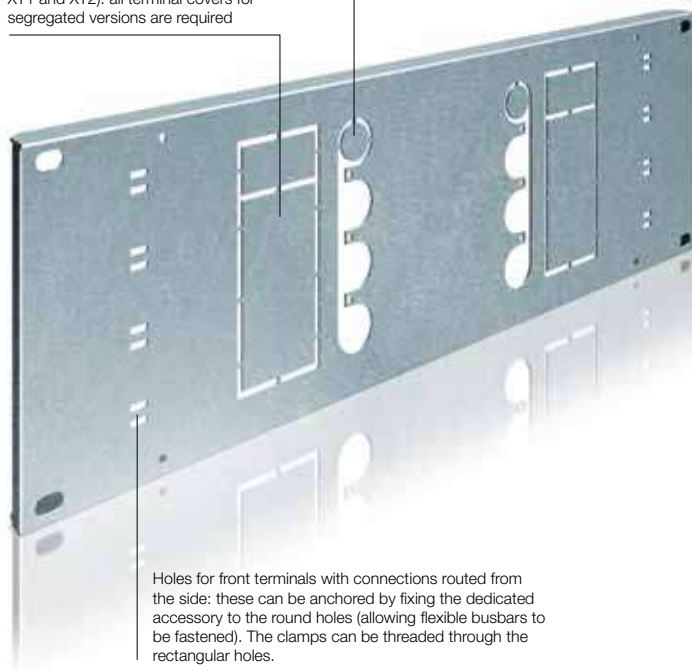

Plate for Tmax XT and Tmax T moulded-case circuit-breakers

Holes with shaped openings for rear connections for 3P circuit-breakers; pre-cut holes included for 4P

Holes for front terminals, with flexible insulated connections that proceed behind the plate for fixed circuit-breakers (for W=400mm only Tmax XT1 and XT2); all terminal covers for segregated versions are required



Holes for front terminals with connections routed from the side: these can be anchored by fixing the dedicated accessory to the round holes (allowing flexible busbars to be fastened). The clamps can be threaded through the rectangular holes.

System pro E power

Quick selection guides

Recommended installation solutions

Modular and Tmax moulded-case circuit-breakers System pro-M			Type of structure/installation				
			Form 1, Form 2b switchboard				
			D=200mm	D=300mm		D=500mm	
			HORIZ.	VERT.	HORIZ.	VERT.	ORIZZ.
TmaxXT1	front terminals with side exit	fixed	■	■	■	■	■
		plug-in			■	■	■
	rear/front terminals with rear exit	fixed+diff	■	■	■	■	■
		fixed	■	■	■	■	■
Tmax XT2	front terminals with side exit	fixed	■	■	■	■	■
		plug-in			■	■	■
	rear/front terminals with rear exit	withdrawable			■	■	■
		withdrawable+ diff			■	■	■
Tmax XT3	front terminals with side exit	fixed+diff	■	■	■	■	■
		fixed	■	■	■	■	■
	rear/front terminals with rear exit	plug-in			■	■	■
		fixed	■	■	■	■	■
Tmax XT4	front terminals with side exit	fixed	■	■	■	■	■
		plug-in			■	■	■
	rear/front terminals with rear exit	withdrawable			■	■	■
		withdrawable+ diff			■	■	■
Tmax T4	front terminals with side exit	fixed+diff	■	■	■	■	■
		fixed	■	■	■	■	■
Tmax T5	front terminals with side exit	fixed	■	■	■	■	■
		plug-in			■	■	■
	rear/front terminals with rear exit	plug-in+diff			■	■	■
		withdrawable			■	■	■
Tmax T6	front terminals with side exit	fixed+diff	■	■	■	■	■
		fixed	■	■	■	■	■
	rear/front terminals with rear exit ⁽¹⁾	withdrawable			■	■	■
		fixed	■	■	■	■	■
Tmax T7	front terminals with side exit	plug-in			■	■	■
		plug-in+diff			■	■	■
	rear/front terminals with rear exit	withdrawable			■	■	■
		fixed			■	■	■
Emax air circuit-breakers	Emax E1.2	front and rear terminals			■	■	■
		rear terminals					■
Emax E2.2	rear terminals	fixed					
		withdrawable					
Emax E4.2	rear terminals	fixed					
		withdrawable					
Emax E6.2	rear terminals	fixed					
		withdrawable					

⁽¹⁾ Front terminals with rear exit, only Form 1. ⁽⁴⁾ Only Form 1.

System pro E power

Quick selection guides

Recommended installation solutions for accessorized apparatus

			Type of structure/installation					
			Form 1, Form 2b switchboard					
			D=200mm		D=300mm		D=500mm	
			HORIZ.	VERT.	HORIZ.	VERT.	HORIZ.	
Tmax moulded-case circuit-breakers with Direct Rotary Handle operating mechanism or motor operator								
Tmax T4	front terminals with side exit	fixed			■	■	■	
	rear/front terminals with rear exit	fixed			■	■	■	
Tmax T5	front terminals with side exit	fixed			■	■	■	
		plug-in			■	■	■	
		withdrawable			■	■	■	
	rear/front terminals with rear exit	fixed			■	■	■	
		plug-in			■	■	■	
		withdrawable			■	■	■	
Tmax T6	front terminals with side exit	fixed			■	■	■	
		withdrawable ⁽²⁾			■	■	■	
	rear/front terminals with rear exit ⁽¹⁾	fixed			■	■	■	
		withdrawable			■	■	■	
Tmax T7	front terminals with side exit	fixed				■	■	
		withdrawable				■	■	
	rear/front terminals with rear exit	fixed			■	■	■	
		withdrawable				■	■	
Tmax XT1	front terminals with side exit	fixed			■	■	■	
		plug-in			■	■	■	
	rear/front terminals with rear exit	fixed			■	■	■	
		plug-in			■	■	■	
Tmax XT2	front terminals with side exit	fixed			■	■	■	
		plug-in			■	■	■	
		withdrawable			■	■	■	
	rear/front terminals with rear exit	fixed			■	■	■	
		plug-in			■	■	■	
		withdrawable			■	■	■	
Tmax XT3	front terminals with side exit	fixed			■	■	■	
		plug-in			■	■	■	
	rear/front terminals with rear exit	fixed			■	■	■	
		plug-in			■	■	■	
Tmax XT4	front terminals with side exit	fixed			■	■	■	
		plug-in			■	■	■	
		withdrawable			■	■	■	
	rear/front terminals with rear exit	fixed			■	■	■	
		plug-in			■	■	■	
		withdrawable			■	■	■	

⁽¹⁾ Front terminals with rear exit, only Form 1.

⁽²⁾ Only Form 1.

Type of structure/installation											
Form 2a-3a, Form 3b, Form 4b switchboard											
D=700mm		D=900mm		D=500mm			D=700mm			D=900mm	
VERT.	HORIZ.	VERT.	HORIZ.	VERT.	ORIZZ.	VERT.	ORIZZ.	VERT.	ORIZZ.	VERT.	
<input type="checkbox"/>	<input type="checkbox"/>	<input type="checkbox"/>	<input type="checkbox"/>	<input type="checkbox"/>							
<input type="checkbox"/>	<input type="checkbox"/>	<input type="checkbox"/>	<input type="checkbox"/>	<input type="checkbox"/>	<input type="checkbox"/>	<input type="checkbox"/>	<input type="checkbox"/>	<input type="checkbox"/>	<input type="checkbox"/>	<input type="checkbox"/>	
<input type="checkbox"/>	<input type="checkbox"/>	<input type="checkbox"/>	<input type="checkbox"/>	<input type="checkbox"/>							
<input type="checkbox"/>	<input type="checkbox"/>	<input type="checkbox"/>	<input type="checkbox"/>	<input type="checkbox"/>							
<input type="checkbox"/>	<input type="checkbox"/>	<input type="checkbox"/>	<input type="checkbox"/>	<input type="checkbox"/>	<input type="checkbox"/>	<input type="checkbox"/>	<input type="checkbox"/>	<input type="checkbox"/>	<input type="checkbox"/>	<input type="checkbox"/>	
<input type="checkbox"/>	<input type="checkbox"/>	<input type="checkbox"/>	<input type="checkbox"/>	<input type="checkbox"/>	<input type="checkbox"/>	<input type="checkbox"/>	<input type="checkbox"/>	<input type="checkbox"/>	<input type="checkbox"/>	<input type="checkbox"/>	
<input type="checkbox"/>	<input type="checkbox"/>	<input type="checkbox"/>	<input type="checkbox"/>	<input type="checkbox"/>	<input type="checkbox"/>	<input type="checkbox"/>	<input type="checkbox"/>	<input type="checkbox"/>	<input type="checkbox"/>	<input type="checkbox"/>	
<input type="checkbox"/>	<input type="checkbox"/>	<input type="checkbox"/>	<input type="checkbox"/>	<input type="checkbox"/>							
<input type="checkbox"/>	<input type="checkbox"/>	<input type="checkbox"/>	<input type="checkbox"/>	<input type="checkbox"/>	<input type="checkbox"/>	<input type="checkbox"/>	<input type="checkbox"/>	<input type="checkbox"/>	<input type="checkbox"/>	<input type="checkbox"/>	
<input type="checkbox"/>	<input type="checkbox"/>	<input type="checkbox"/>	<input type="checkbox"/>	<input type="checkbox"/>							
<input type="checkbox"/>	<input type="checkbox"/>	<input type="checkbox"/>	<input type="checkbox"/>	<input type="checkbox"/>							
<input type="checkbox"/>	<input type="checkbox"/>	<input type="checkbox"/>	<input type="checkbox"/>	<input type="checkbox"/>	<input type="checkbox"/>	<input type="checkbox"/>	<input type="checkbox"/>	<input type="checkbox"/>	<input type="checkbox"/>	<input type="checkbox"/>	
<input type="checkbox"/>	<input type="checkbox"/>	<input type="checkbox"/>	<input type="checkbox"/>	<input type="checkbox"/>							
<input type="checkbox"/>	<input type="checkbox"/>	<input type="checkbox"/>	<input type="checkbox"/>	<input type="checkbox"/>							
<input type="checkbox"/>	<input type="checkbox"/>	<input type="checkbox"/>	<input type="checkbox"/>	<input type="checkbox"/>	<input type="checkbox"/>	<input type="checkbox"/>	<input type="checkbox"/>	<input type="checkbox"/>	<input type="checkbox"/>	<input type="checkbox"/>	
<input type="checkbox"/>	<input type="checkbox"/>	<input type="checkbox"/>	<input type="checkbox"/>	<input type="checkbox"/>							
<input type="checkbox"/>	<input type="checkbox"/>	<input type="checkbox"/>	<input type="checkbox"/>	<input type="checkbox"/>	<input type="checkbox"/>	<input type="checkbox"/>	<input type="checkbox"/>	<input type="checkbox"/>	<input type="checkbox"/>	<input type="checkbox"/>	
<input type="checkbox"/>	<input type="checkbox"/>	<input type="checkbox"/>	<input type="checkbox"/>	<input type="checkbox"/>							
<input type="checkbox"/>	<input type="checkbox"/>	<input type="checkbox"/>	<input type="checkbox"/>	<input type="checkbox"/>	<input type="checkbox"/>	<input type="checkbox"/>	<input type="checkbox"/>	<input type="checkbox"/>	<input type="checkbox"/>	<input type="checkbox"/>	
<input type="checkbox"/>	<input type="checkbox"/>	<input type="checkbox"/>	<input type="checkbox"/>	<input type="checkbox"/>							
<input type="checkbox"/>	<input type="checkbox"/>	<input type="checkbox"/>	<input type="checkbox"/>	<input type="checkbox"/>	<input type="checkbox"/>	<input type="checkbox"/>	<input type="checkbox"/>	<input type="checkbox"/>	<input type="checkbox"/>	<input type="checkbox"/>	
<input type="checkbox"/>	<input type="checkbox"/>	<input type="checkbox"/>	<input type="checkbox"/>	<input type="checkbox"/>	<input type="checkbox"/>	<input type="checkbox"/>	<input type="checkbox"/>	<input type="checkbox"/>	<input type="checkbox"/>	<input type="checkbox"/>	
<input type="checkbox"/>	<input type="checkbox"/>	<input type="checkbox"/>	<input type="checkbox"/>	<input type="checkbox"/>							
<input type="checkbox"/>	<input type="checkbox"/>	<input type="checkbox"/>	<input type="checkbox"/>	<input type="checkbox"/>	<input type="checkbox"/>	<input type="checkbox"/>	<input type="checkbox"/>	<input type="checkbox"/>	<input type="checkbox"/>	<input type="checkbox"/>	
<input type="checkbox"/>	<input type="checkbox"/>	<input type="checkbox"/>	<input type="checkbox"/>	<input type="checkbox"/>							
<input type="checkbox"/>	<input type="checkbox"/>	<input type="checkbox"/>	<input type="checkbox"/>	<input type="checkbox"/>	<input type="checkbox"/>	<input type="checkbox"/>	<input type="checkbox"/>	<input type="checkbox"/>	<input type="checkbox"/>	<input type="checkbox"/>	
<input type="checkbox"/>	<input type="checkbox"/>	<input type="checkbox"/>	<input type="checkbox"/>	<input type="checkbox"/>	<input type="checkbox"/>	<input type="checkbox"/>	<input type="checkbox"/>	<input type="checkbox"/>	<input type="checkbox"/>	<input type="checkbox"/>	
<input type="checkbox"/>	<input type="checkbox"/>	<input type="checkbox"/>	<input type="checkbox"/>	<input type="checkbox"/>	<input type="checkbox"/>	<input type="checkbox"/>	<input type="checkbox"/>	<input type="checkbox"/>	<input type="checkbox"/>	<input type="checkbox"/>	
<input type="checkbox"/>	<input type="checkbox"/>	<input type="checkbox"/>	<input type="checkbox"/>	<input type="checkbox"/>	<input type="checkbox"/>	<input type="checkbox"/>	<input type="checkbox"/>	<input type="checkbox"/>	<input type="checkbox"/>	<input type="checkbox"/>	
<input type="checkbox"/>	<input type="checkbox"/>	<input type="checkbox"/>	<input type="checkbox"/>	<input type="checkbox"/>	<input type="checkbox"/>	<input type="checkbox"/>	<input type="checkbox"/>	<input type="checkbox"/>	<input type="checkbox"/>	<input type="checkbox"/>	
<input type="checkbox"/>	<input type="checkbox"/>	<input type="checkbox"/>	<input type="checkbox"/>	<input type="checkbox"/>	<input type="checkbox"/>	<input type="checkbox"/>	<input type="checkbox"/>	<input type="checkbox"/>	<input type="checkbox"/>	<input type="checkbox"/>	
<input type="checkbox"/>	<input type="checkbox"/>	<input type="checkbox"/>	<input type="checkbox"/>	<input type="checkbox"/>	<input type="checkbox"/>	<input type="checkbox"/>	<input type="checkbox"/>	<input type="checkbox"/>	<input type="checkbox"/>	<input type="checkbox"/>	

System pro E power

Quick selection guides

Recommended installation solutions for accessorized apparatus

3

			Type of structure/installation				
			Form 1, Form 2b switchboard				
			D=200mm		D=300mm		D=500mm
			HORIZ.	VERT.	HORIZ.	VERT.	HORIZ.
Tmax interlocked, interlocked motor-operated moulded-case circuit-breakers							
Tmax T4	front terminals with side exit	fixed					■
	rear/front terminals with rear exit	fixed					■
Tmax T5	front terminals with side exit	fixed					■
		plug-in					■
	rear/front terminals with rear exit	withdrawable					■
		fixed					■
Tmax T6	front terminals with side exit	plug-in					■
		withdrawable					■
	rear/front terminals with rear exit ⁽³⁾	fixed					■
		withdrawable					■
Tmax T7	front terminals with side exit	fixed					■
		withdrawable					■
	rear/front terminals with rear exit	fixed					■
		withdrawable					■
Tmax XT1	front terminals with side exit	fixed			■		■
		plug-in			■		■
	rear/front terminals with rear exit	fixed			■		■
		plug-in			■		■
Tmax XT2	front terminals with side exit	fixed			■		■
		plug-in			■		■
		withdrawable			■		■
	rear/front terminals with rear exit	fixed			■		■
		plug-in			■		■
		withdrawable			■		■
Tmax XT3	front terminals with side exit	fixed			■		■
		plug-in			■		■
	rear/front terminals with rear exit	fixed			■		■
		plug-in			■		■
Tmax XT4	front terminals with side exit	fixed			■		■
		plug-in			■		■
		withdrawable			■		■
	rear/front terminals with rear exit	fixed			■		■
		plug-in			■		■
		withdrawable			■		■
Emax air circuit-breakers							
Emax E1.2	front and rear terminals	fixed			■	■	■
	rear terminals	withdrawable					■
Emax E2.2	rear terminals	fixed					
		withdrawable					
Emax E4.2	rear terminals	fixed					
		withdrawable					
Emax E6.2	rear terminals	fixed					
		withdrawable					

⁽³⁾ Front terminals with rear exit, only Form 1.

⁽⁴⁾ Only Form 1.

System pro E power

Quick selection guides

Kits for moulded-case circuit-breakers

Tmax XT horizontal installation

To assemble these kits, order the dedicated intermediate depth uprights PUKI1800 for H= 1800mm or PUKI2000 for H=2000mm. Intermediate uprights are not required for assembling fixed Tmax XT1, XT2, XT3, XT4, T4, T5, T6 and XT1, XT3 with Direct Rotary Handle only in non-segregated structures. Order the dedicated fixed frame PFPF... or swing frame PFPS... for assembling internal panels. For D=300mm structures, consult the details on page 3/21.

3

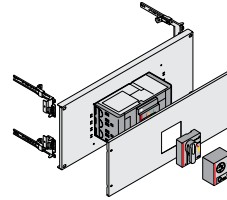
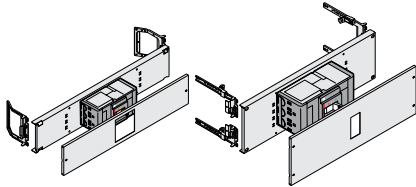

NON-ACCESSORIZED CIRCUIT-BREAKERS

Front or rear CB connections	No. poles	Dimensions (mm)		No. CB per compartment	Fixed	Plug-in	Withdrawable
		H	W				
XT1	3P 4P	150	400	1	PHBX1401		
	3P 4P	150	600	1	PHCX1401		
	3P 4P	200	400	1	PHBX1101	PHBX1407	
	3P 4P	200	600	1	PHCX1101	PHCX1407	
XT2	3P	150	400	1	PHBX2301		
	3P	150	600	1	PHCX2301		
	3P 4P	200	400	1	PHBX2401	PHBX2407	PHBX2310 ⁽¹⁾
	3P 4P	200	600	1	PHCX2401	PHCX2407	PHCX2310 ⁽¹⁾
	3P 4P	200	800	1	PHDX2401		
	3P 4P	250	400	1			PHBX2410
XT3	3P 4P	250	600	1			PHCX2410
	3P	150	400	1	PHBX3301 ⁽³⁾		
	3P	150	600	1	PHCX3301		
	3P 4P	200	400	1	PHBX3401 ⁽³⁾	PHBX3407	
XT4	3P 4P	200	600	1	PHCX3401	PHCX3407	
	3P	150	400	1	PHBX4301 ⁽³⁾		
	3P	150	600	1	PHCX4301		
	3P 4P	200	400	1	PHBX4401 ⁽³⁾	PHBX4407	
	3P 4P	200	600	1	PHCX4401	PHCX4407	
	3P 4P	200	800	1	PHDX4401		
	3P 4P	250	400	1			PHBX4410
	3P 4P	250	600	1			PHCX4410

⁽¹⁾ Only 3 poles

⁽²⁾ Only 4 poles

⁽³⁾ Not compatible with high terminal covers.

ACCESSORIZED CIRCUIT-BREAKERS

Front or rear CB connections	No. poles	Dimensions (mm)		No. CB per compartment	Fixed	
		H	W		Residual current device	Direct Rotary Handle
XT1	3P	200	400	1	PHBX1323	
	3P	200	600	1	PHCX1323	
	3P 4P	150	400	1		PHBX1405
	3P 4P	150	600	1		PHCX1405
	3P 4P	200	400	1	PHBX1423 ⁽²⁾	PHBX1105
	3P 4P	200	600	1	PHCX1423 ⁽²⁾	PHCX1105
	3P 4P	500	400	2		
	3P 4P	500	600	2		
	4P	200	800	1	PHDX1423	
	XT2	3P 4P	200	400	1	PHBX2423 ⁽²⁾
3P 4P		200	600	1	PHCX2423 ⁽²⁾	PHCX2405
3P 4P		200	800	1	PHDX2423 ⁽²⁾	
3P 4P		250	400	1		
3P 4P		250	600	1		
3P 4P		500	400	2		
3P 4P		500	600	2		
4P		250	800	1		
XT3	3P	150	400	1		PHBX3305
	3P	150	600	1		PHCX3305
	3P 4P	200	400	1		PHBX3405
	3P 4P	200	600	1		PHCX3405
	3P 4P	500	400	2		
	3P 4P	500	600	2		
	4P	250	400	1	PHBX3423 ⁽⁴⁾	
	4P	250	600	1	PHCX3423	
XT4	4P	200	800	1	PHDX3423	
	3P 4P	200	400	1	PHBX4423 ⁽²⁾⁽⁴⁾	PHBX4405
	3P 4P	200	600	1	PHCX4423 ⁽²⁾	PHCX4405
	3P 4P	200	800	1	PHDX4423 ⁽²⁾	
	3P 4P	250	400	1		
	3P 4P	250	600	1		
	3P 4P	500	400	2		
	3P 4P	500	600	2		
4P	250	800	1			

⁽¹⁾ Only 3 poles

⁽²⁾ Only 4 poles

⁽³⁾ Compatible residual current devices: RC Inst. XT1-XT3, RC Sel. XT1-XT3 and RC Sel. XT2-XT4 Type A. For XT1-XT3 fixed with residual current device high terminal covers are not available.

⁽⁴⁾ Not compatible with high terminal covers.

For fixed and withdrawable 3P breakers Tmax XT, non accessorized and mounted on 3/4P kit, it is necessary to order the dedicated cover flanges: AD3305 flange for XT1 3P mounted on plate, AD3306 flange for XT2 3P mounted on plate, AD3307 flange for XT3 3P mounted on plate, AD3308 flange for XT4 3P mounted on plate. With interlocked or interlocked motor-operated kits, it is necessary to order the quantity of flanges equal to the quantity of breakers.

> Order codes page pag. 3/20

> Technical details page 7/1

> Overall dimensions page 8/1

				Plug-in					Withdrawable				
Motor operator	Interlocked	Interlocked motor-operated	Residual current device ⁽³⁾	Direct Rotary Handle	Motor operator	Interlocked	Interlocked motor-operated	Residual current device ⁽³⁾	Direct Rotary Handle	Motor operator	Interlocked	Interlocked motor-operated	
PHBX1404				PHBX1427	PHBX1409								
PHCX1404				PHCX1427	PHCX1409								
	PHBX1422	PHBX1424				PHBX1422	PHBX1424						
	PHCX1422	PHCX1424				PHCX1422	PHCX1424						
PHBX2404				PHBX2427	PHBX2409				PHBX2300 ⁽¹⁾	PHBX2312 ⁽¹⁾			
PHCX2404				PHCX2427	PHCX2409				PHCX2300 ⁽¹⁾	PHCX2312 ⁽¹⁾			
PHDX2404													
			PHBX2428 ⁽²⁾						PHBX2400	PHBX2412			
								PHCX2417 ⁽²⁾	PHCX2400	PHCX2412			
	PHBX2402	PHBX2424				PHBX2431	PHBX2424				PHBX2425	PHBX2425	
	PHCX2402	PHCX2424				PHCX2431	PHCX2424				PHCX2425	PHCX2425	
			PHDX2428										
PHBX3404				PHBX3427	PHBX3409								
PHCX3404				PHCX3427	PHCX3409								
	PHBX3422	PHBX3424				PHBX3422	PHBX3424						
	PHCX3422	PHCX3424				PHCX3422	PHCX3424						
PHBX4404				PHBX4427	PHBX4409								
PHCX4404				PHCX4427	PHCX4409								
PHDX4404													
			PHBX4428 ⁽²⁾						PHBX4400	PHBX4412			
								PHCX4417 ⁽²⁾	PHCX4400	PHCX4412			
	PHBX4402	PHBX4424				PHBX4431	PHBX4424				PHBX4425	PHBX4425	
	PHCX4402	PHCX4424				PHCX4431	PHCX4424				PHCX4425	PHCX4425	
			PHDX4428										

System pro E power

Quick selection guides

Kits for moulded-case circuit-breakers

Tmax T horizontal installation

To assemble these kits, order the dedicated intermediate depth uprights PUK1800 for H= 1800mm or PUK12000 for H=2000mm. Intermediate uprights are not required for assembling fixed Tmax XT1, XT2, XT3, XT4, T4, T5, T6 and XT1, XT3 with Direct Rotary Handle only in non-segregated structures. Order the dedicated fixed frame PFPF... or swing frame PFPS... for assembling internal panels. For D=300mm structures, consult the details on page 3/21.

3

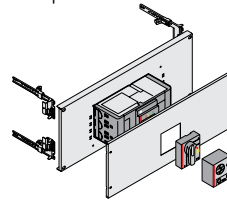
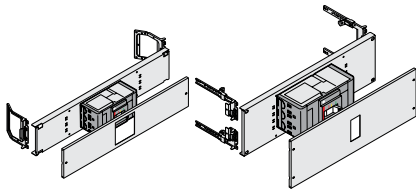

NON-ACCESSORIZED CIRCUIT-BREAKERS

Front or rear circuit-breaker connec.	No. poles	Dimensions (mm)		No. CB per compart.	Fixed	Plug-in	Withdraw.	
		H	W					
T4	3P	150	400	1	PHBT4301 ⁽²⁾			
	3P	150	600	1	PHCT4301			
	3P 4P	200	400	1	PHBT4406 ⁽²⁾			
	3P 4P	200	600	1	PHCT4406			
T5 400A	3P	200	400	1		PHBT5326		
	3P	200	600	1		PHCT5326		
	3P	200	800	1		PHDT5326		
	3P	300	400	1			PHBT5314	
	3P	300	600	1			PHCT5314	
	3P	300	800	1			PHDT5314	
	400A/630A	3P	200	400	1	PHBT5306 ⁽²⁾		
		3P	200	600	1	PHCT5306		
		3P	200	800	1	PHDT5306		
	400A	3P 4P	250	400	1		PHBT5426	
3P 4P		250	600	1		PHCT5426		
3P 4P		250	800	1		PHDT5426		
3P 4P		350	400	1			PHBT5414	
3P 4P		350	600	1			PHCT5414	
3P 4P		350	800	1			PHDT5414	
400A/630A	3P 4P	250	400	1	PHBT5406 ⁽²⁾			
	3P 4P	250	600	1	PHCT5406			
	3P 4P	250	800	1	PHDT5406			
630A	3P	200	600			PHCT5307 ■		
	3P	300	600				PHCT5310 ■	
T6	3P	300	600	1	PHCT6301			
	3P	300	800	1	PHDT6301			
	3P 4P	350	600	1	PHCT6401		PHCT6314 ⁽¹⁾ ■	
	3P 4P	350	800	1	PHDT6401		PHDT6314 ⁽¹⁾ ■	
	3P 4P	500	600	1			PHCT6410 ■	
	3P 4P	500	800	1			PHDT6414 ■	
T7	3P	300	600	1	PHCT7329			
	3P	300	800	1	PHDT7329			
	3P	400	600	1				
	3P	400	800	1				
	3P 4P	350	600	1	PHCT7420			
	3P 4P	350	800	1	PHDT7420			
	3P 4P	500	600	1			PHCT7430 *	
	3P 4P	500	800	1			PHDT7430 *	

⁽¹⁾ Only 3 poles

⁽²⁾ Only 4 poles

⁽³⁾ Not compatible with high terminal covers.

■ Front terminals, only Form 1

* Only rear terminals

ACCESSORIZED CIRCUIT-BREAKERS

Front or rear circuit-breaker connections	No. poles	Dimensions (mm)		No. CB per compart.	Fixed		
		H	W		Residual current device ⁽⁴⁾	Direct Rotary Handle	
T4	3P 4P	200	400	1		PHBT4406 ⁽³⁾	
	3P 4P	200	600	1	PHCT4423 ⁽²⁾	PHCT4406	
	3P 4P	600	400	2			
	3P 4P	600	600	2			
	3P 4P	600	800	2			
	3P 4P	600	800	2			
T5 400A	3P	200	400	1			
	3P	200	600	1			
	3P	200	800	1			
	3P	300	400	1			
	3P	300	600	1			
	3P	300	800	1			
400A/630A	3P	200	400	1		PHBT5306 ⁽³⁾	
	3P	200	600	1		PHCT5306	
	3P	200	800	1		PHDT5306	
400A	3P 4P	250	400	1			
	3P 4P	250	600	1			
	3P 4P	250	800	1			
	3P 4P	350	400	1			
	3P 4P	350	600	1			
	3P 4P	350	800	1			
	3P 4P	600	400	2			
	3P 4P	600	600	2			
	3P 4P	600	800	2			
	400A/630A	3P 4P	250	400	1		PHBT5406 ⁽³⁾
		3P 4P	250	600	1		PHCT5406
		3P 4P	250	800	1		PHDT5406
3P 4P		250	800	1			
3P 4P		600	600	2			
3P 4P		600	800	2			
400A	4P	250	600	1	PHCT5423		
	4P	250	800	1	PHDT5423		
T6	3P	300	600	1		PHCT6305	
	3P	300	800	1		PHDT6305	
	3P 4P	350	600	1		PHCT6405	
	3P 4P	350	800	1		PHDT6405	
	3P 4P	500	600	1			
	3P 4P	500	800	1			
	3P 4P	700	600	2			
	T7	3P	300	600	1		PHCT7329
		3P	300	800	1		PHDT7329
		3P 4P	350	600	1		PHCT7420
		3P 4P	350	800	1		PHDT7420
		3P 4P	400	600	1		
3P 4P		400	800	1			
3P 4P		500	600	1			
3P 4P		500	800	1			

⁽¹⁾ Only 3 poles

⁽²⁾ Only 4 poles

⁽³⁾ Not compatible with high terminal covers.

⁽⁴⁾ Compatible residual current devices: RC222 for T4 and T5.

				Plug-in				Withdrawable			
Motor operator	Interlocked	Interlocked motor-operated	Direct rotary handle	Motor operator	Interlocked	Interlocked motor-operated	Direct Rotary Handle	Motor operator	Interlocked	Interlocked motor-operated	
PHBT4404											
PHCT4404											
	PHBT4402										
	PHCT4402	PHCT4403									
	PHDT4402	PHDT4403									
			PHBT5326	PHBT5309							
			PHCT5326	PHCT5309							
			PHDT5326	PHDT5309							
							PHBT5314	PHBT5312			
							PHCT5314	PHCT5312			
							PHDT5314	PHDT5312			
PHBT5304											
PHCT5304											
PHDT5304											
			PHBT5426	PHBT5409							
			PHCT5426	PHCT5409							
			PHDT5426	PHDT5409							
							PHBT5414	PHBT5412			
							PHCT5414	PHCT5412			
							PHDT5414	PHDT5412			
					PHCT5431	PHCT5432			PHCT5425	PHCT5411	
									PHDT5425	PHDT5411	
PHBT5404											
PHCT5404											
PHDT5404											
	PHCT5402	PHCT5403									
PHCT6304											
PHDT6304											
PHCT6404							PHCT6314 ⁽¹⁾ ■	PHCT6312 ⁽¹⁾ ■			
PHDT6404							PHDT6314 ⁽¹⁾ ■	PHDT6312 ⁽¹⁾ ■			
							PHCT6400 ■	PHCT6412 ■			
							PHDT6414 ■	PHDT6412 ■			
	PHCT6402	PHCT6403							PHCT6425 ■	PHCT6411 ■	
PHCT7329	PHCT7329	PHCT7329									
PHDT7329	PHDT7329	PHDT7329									
PHCT7420											
PHDT7420											
	PHCT7418	PHCT7418									
	PHDT7418	PHDT7418									
							PHCT7430 *	PHCT7430 *	PHCT7430 *	PHCT7430 *	
							PHDT7430 *	PHDT7430 *	PHDT7430 *	PHDT7430 *	

■ Front terminals, only Form 1
 * Only rear terminals

System pro E power

Quick selection guides

Kits for moulded-case circuit-breakers

Tmax XT vertical installation

To assemble these kits, order the dedicated intermediate depth uprights PUK1800 for H= 1800mm or PUK2000 for H=2000mm. Intermediate uprights are not required for assembling fixed Tmax XT1, XT2, XT3, XT4, T4, T5, T6 and XT1, XT3 with Direct Rotary Handle only in non-segregated structures. Order the dedicated fixed frame PFPF... or swing frame PFPS... for assembling internal panels. For D=300mm structures, consult the details on page 3/21.

3

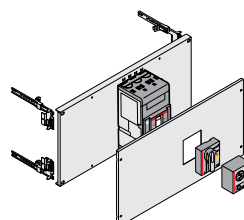
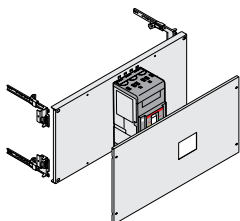

NON-ACCESSORIZED CIRCUIT-BREAKERS

Front or rear circuit-breaker connections	No. poles	Dimensions (mm)		No. adjacent CB	Fixed	Plug-in	Withdrawable
		H	W				
XT1	3P 4P	300	400	1	PVBX1401	PVBX1407	
	3P 4P	300	600	1	PVCX1401	PVCX1407	
	3P 4P	300	600	3		PVCX1707	
	3P 4P	300	800	4		PVDX1807	
XT2	3P 4P	300	400	1	PVBX2401	PVBX2407	PVBX2410
	3P 4P	300	600	1	PVCX2401	PVCX2407	PVCX2410
	3P 4P	300	600	3	PVCX2701	PVCX2707	
	3P 4P	300	800	4	PVDX2801	PVDX2807	
XT3	3P 4P	300	400	1	PVBX3401	PVBX3407	
	3P	300	600	3		PVCX3707	
	3P 4P	300	600	1	PVCX3401	PVCX3407	
	3P 4P	300	600	2		PVCX3607	
	3P	300	800	4		PVDX3807	
XT4	3P 4P	300	400	1	PVBX4401		
	3P 4P	300	600	1	PVCX4401		
	3P 4P	300	600	2	PVCX4601		
	3P	300	600	3	PVCX4701		
	3P 4P	300	800	3	PVDX4701		
	3P	300	800	4	PVDX4801		
	3P 4P	350	400	1		PVBX4407	PVBX4410
	3P	350	600	3		PVCX4707	
	3P 4P	350	600	1		PVCX4407	PVCX4410
	3P 4P	350	600	2		PVCX4607	
	3P	350	800	4		PVDX4807	
3P 4P	350	800	3		PVDX4707		

ACCESSORIZED CIRCUIT-BREAKERS

Front or rear circuit-breaker connections	No. poles	Dimensions (mm)		No. adjacent CB	Fixed	
		H	W		Residual current device ⁽²⁾	
XT1	3P 4P	300	400	1	PVBX1423 ⁽¹⁾	
	3P 4P	300	600	1	PVCX1423 ⁽¹⁾	
XT2	3P 4P	300	400	1		
	3P 4P	300	600	1		
	4P	350	400	1	PVBX2423	
	4P	350	600	1	PVCX2423	
XT3	3P 4P	300	400	1		
	3P 4P	300	600	1		
	4P	400	400	1	PVBX3423	
	4P	400	600	1	PVCX3423	
XT4	3P 4P	300	400	1		
	3P 4P	300	600	1		
	3P 4P	350	400	1		
	3P 4P	350	600	1		
	4P	400	400	1	PVBX4423	
	4P	400	600	1	PVCX4423	

⁽¹⁾ Only 4 poles.

⁽²⁾ Compatible residual current devices: RC Inst. XT1-XT3, RC Sel. XT1-XT3 and RC Sel. XT2-XT4 Type A. For XT1-XT3 fixed with residual current device high terminal covers are not available.

For fixed and withdrawable 3P breakers Tmax XT, non accessorized and mounted on 3/4P kit, it is necessary to order the dedicated cover flanges: AD3305 flange for XT1 3P mounted on plate, AD3306 flange for XT2 3P mounted on plate, AD3307 flange for XT3 3P mounted on plate, AD3308 flange for XT4 3P mounted on plate. With interlocked or interlocked motor-operated kits, it is necessary to order the quantity of flanges equal to the quantity of breakers

		Plug-in		Withdrawable		
Direct rotary handle	Motor operator	Direct rotary handle	Motor operator	Residual current device ⁽²⁾	Direct rotary handle	Motor operator
PVBX1405	PVBX1404	PVBX1427	PVBX1409			
PVCX1405	PVCX1404	PVCX1427	PVCX1409			
PVBX2405	PVBX2404	PVBX2427	PVBX2409		PVBX2400	PVBX2412
PVCX2405	PVCX2404	PVCX2427	PVCX2409		PVCX2400	PVCX2412
				PVBX2417		
				PVCX2417		
PVBX3405	PVBX3404	PVBX3427	PVBX3409			
PVCX3405	PVCX3404	PVCX3427	PVCX3409			
PVBX4405	PVBX4404					
PVCX4405	PVCX4404					
		PVBX4427	PVBX4409		PVBX4400	PVBX4412
		PVCX4427	PVCX4409		PVCX4400	PVCX4412
				PVBX4417		
				PVCX4417		

System pro E power

Quick selection guides

Kits for moulded-case circuit-breakers

Tmax T vertical installation

To assemble these kits, order the dedicated intermediate depth uprights PUK1800 for H= 1800mm or PUK12000 for H=2000mm. Intermediate uprights are not required for assembling fixed Tmax XT1, XT2, XT3, XT4, T4, T5, T6 and XT1, XT3 with Direct Rotary Handle only in non-segregated structures. Order the dedicated fixed frame PFPF.... or swing frame PFFS.... for assembling internal panels. For D=300mm structures, consult the details on page 3/21.

3

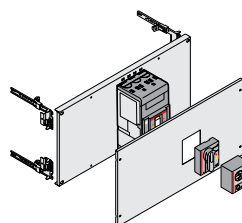
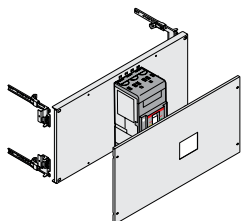

NON-ACCESSORIZED CIRCUIT-BREAKERS

Front or rear circuit-breaker connections	No. poli	Dimensions (mm)		No. adjacent CB	Fixed	Plug-in	Withdrawable	
		H	W					
T4	3P 4P	350	400	1	PVBT4406			
	3P 4P	350	600	1	PVCT4406			
T5	3P 4P	350	800	2			PVDT5610	
	3P	350	1000	4			PVFT5810	
	3P 4P	350	1000	3			PVFT5710	
	400A	3P 4P	350	400	1		PVBT5426	PVBT5414
		3P 4P	350	600	1		PVCT5426	PVCT5414
		3P 4P	350	800	1		PVDT5426	PVDT5414
	400A/630A	3P 4P	350	400	1	PVBT5406		
		3P 4P	350	600	1	PVCT5406		
		3P 4P	350	800	1	PVDT5406		
	630A ⁽¹⁾	3P	450	600	3	PVCT5710		
3P		450	800	4	PVDT5810			
3P		450	600	2			PVCT5601	
3P		450	800	3			PVDT5701	
3P		450	400	1			PVBT5319	
3P		450	600	1		PVCT5307		
T6	3P	450	400	1			PVBT6314	
	3P 4P	400	400	1	PVBT6401			
	3P 4P	400	600	1	PVCT6401			
	3P 4P	400	800	1	PVDT6401			
	3P 4P	450	600	1			PVCT6414 ■	
	3P 4P	450	800	1			PVDT6414 ■	
	3P 4P	450	1000	2			PVFT6610 ■	
T7	3P 4P	450	600	1	PVCT7419			
	3P 4P	450	800	1	PVDT7419			
	3P 4P	500	600	1			PVCT7413 *	
	3P 4P	500	800	1			PVDT7413 *	
	3P 4P	500	1000	2			PVFT7633 *	

⁽¹⁾ Only front terminals not segregated

■ Front terminals, only Form 1
* Only rear terminals

ACCESSORIZED CIRCUIT-BREAKERS

Rear circuit-breaker connections	No. poles	Dimensions (mm)		No. adjacent CB	Fixed		
		H	W		Residual current device ⁽¹⁾		
T4	3P 4P	350	400	1			
	3P 4P	350	600	1			
	4P	450	400	1	PVBT4423		
T5	4P	450	600	1	PVCT4423		
	3P 4P	350	800	2			
	3P	350	1000	4			
400A	3P 4P	350	1000	3			
	3P 4P	350	400	1			
	3P 4P	350	600	1			
	3P 4P	350	800	1			
	4P	450	400	1	PVBT5423		
	4P	450	600	1	PVCT5423		
	4P	450	800	1	PVDT5423		
	400A/630A	3P 4P	350	400	1		
		3P 4P	350	600	1		
		3P 4P	350	800	1		
T6	3P	450	400	1			
	3P 4P	400	400	1			
	3P 4P	400	600	1			
	3P 4P	400	800	1			
	3P 4P	450	600	1			
	3P 4P	450	800	1			
	3P 4P	450	1000	2			
T7	3P 4P	450	600	1			
	3P 4P	450	800	1			
	3P 4P	500	600	1			
	3P 4P	500	800	1			
	3P 4P	500	1000	2			
	3P 4P	500	1000	2			

⁽¹⁾ Compatible residual current devices: RC222 for T4 and T5.

				Plug-in		Withdrawable				
Direct rotary handle	Motor operator	Interlocked	Interlocked motor-operated	Residual current device ⁽¹⁾	Direct rotary handle	Direct rotary handle	Motor operator	Interlocked	Interlocked motor-operated	
PVBT4406	PVBT4404									
PVCT4406	PVCT4404									
							PVDT5612			
							PVFT5812			
							PVFT5712			
						PVBT5426	PVBT5414	PVBT5412		
						PVCT5426	PVCT5414	PVCT5412		
						PVDT5426	PVDT5414	PVDT5412		
				PVBT5428						
				PVCT5428						
				PVDT5428						
PVBT5406	PVBT5404									
PVCT5406	PVCT5404									
PVDT5406	PVDT5404									
						PVBT6314	PVBT6312			
PVBT6405	PVBT6404									
PVCT6405	PVCT6404									
PVDT6405	PVDT6404									
						PVCT6414 ■	PVCT6412 ■			
						PVDT6414 ■	PVDT6412 ■			
							PVFT6612 ■			
	PVCT7419	PVCT7419	PVCT7419							
	PVDT7419	PVDT7419	PVDT7419							
							PVCT7413 *	PVCT7413 *	PVCT7413 *	
							PVDT7413 *	PVDT7413 *	PVDT7413 *	
							PVFT7633 *			

■ Front terminals, only Form 1
 * Only rear terminals

System pro E power

Quick selection guides

Kits for air circuit-breakers

SACE Emax 2 horizontal / vertical installation

To assemble these kits, order the dedicated intermediate depth upright PUK1800 for H= 1800mm or PUKI2000 for H=2000mm. Order the dedicated fixed frame PFPF.... or swing frame PFPS.... for assembling internal panels.

3

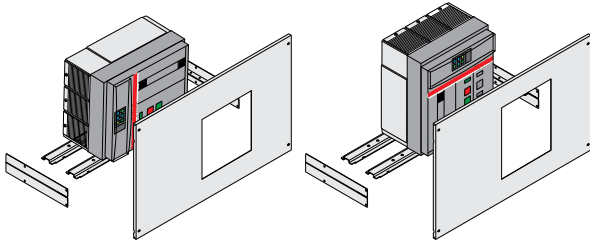

NON-ACCESSORIZED CIRCUIT-BREAKERS

	No. poles	Dimensions (mm)		Fixed	Withdrawable
		H	W		
Front or rear connections, horizontal installation					
E1.2	3P 4P	400	600	PHCE1241	
	3P 4P	400	800	PHDE1241	
	3P 4P	500	600		PHCE1240 *
	3P 4P	500	800		PHDE1240 *
Front or rear connections, vertical installation					
E1.2	3P 4P	450	400	PVBE1241	
	3P 4P	450	600	PVCE1241	
	3P 4P	450	800	PVDE1241	
	3P 4P	450	800	PVDE1262 ⁽¹⁾	
	3P 4P	500	600		PVCE1240 *
	3P 4P	500	800		PVDE1240 *
	3P 4P	500	1000		PVFE1263 ⁽¹⁾ *
	Rear connections, vertical installation				
E2.2	3P 4P	600	600	PVCE2441	PVCE2450
	3P 4P	600	800	PVDE2441	PVDE2440
E4.2	3P 4P	600	600	PVCE2442	PVCE4350 ⁽²⁾
	3P 4P	600	800	PVDE2441	PVDE2440
E6.2	3P	700	1000		PVFE6230
E6.2 Neutral 50%	3P/4P	700	1000	PVFE6231	
E6.2 Neutral 50/100%	4P	700	1250		PVGE6230
E6.2 Neutral 50/100%	4P	700	1250	PVGE6231	

ACCESSORIZED CIRCUIT-BREAKERS

Rear circuit-breaker connections	No. poli	Dimensions (mm)		Fixed Interlocked	Withdrawable Interlocked
		H	W		
Front or rear connections, horizontal installation					
E1.2	3P 4P	400	600	PHCE1241	
	3P 4P	400	800	PHDE1241	
	3P 4P	500	600		PHCE1240
	3P 4P	500	800		PHDE1240
	Front or rear connections, vertical installation				
E1.2	3P 4P	450	400	PVBE1241	
	3P 4P	450	600	PVCE1241	
	3P 4P	450	800	PVDE1241	
	3P 4P	500	600		PVCE1240 *
	3P 4P	500	800		PVDE1240 *
	Rear connections, vertical installation				
E2.2	3P 4P	600	600	PVCE2441	PVCE2450
	3P 4P	600	800	PVDE2441	PVDE2440
E4.2	3P	600	600		PVCE4350
	3P 4P	600	800	PVDE2441	PVDE2440
E6.2	3P	700	1000	PVFE6231	PVFE6230
E6.2 50/100% Neutral	4P	700	1250	PVGE6231	PVGE6230

For 3200A busbar systems use structures with D=700mm, for 4000A busbar systems use structures with D=900mm.

⁽¹⁾ Kit for 2 adjacent circuit-breakers.

⁽²⁾ Only 3 poles.

* Only rear terminals.

Guide to the order codes

The new code is formed by 4 letters standing for English terms and 4 numbers, without spaces in between.

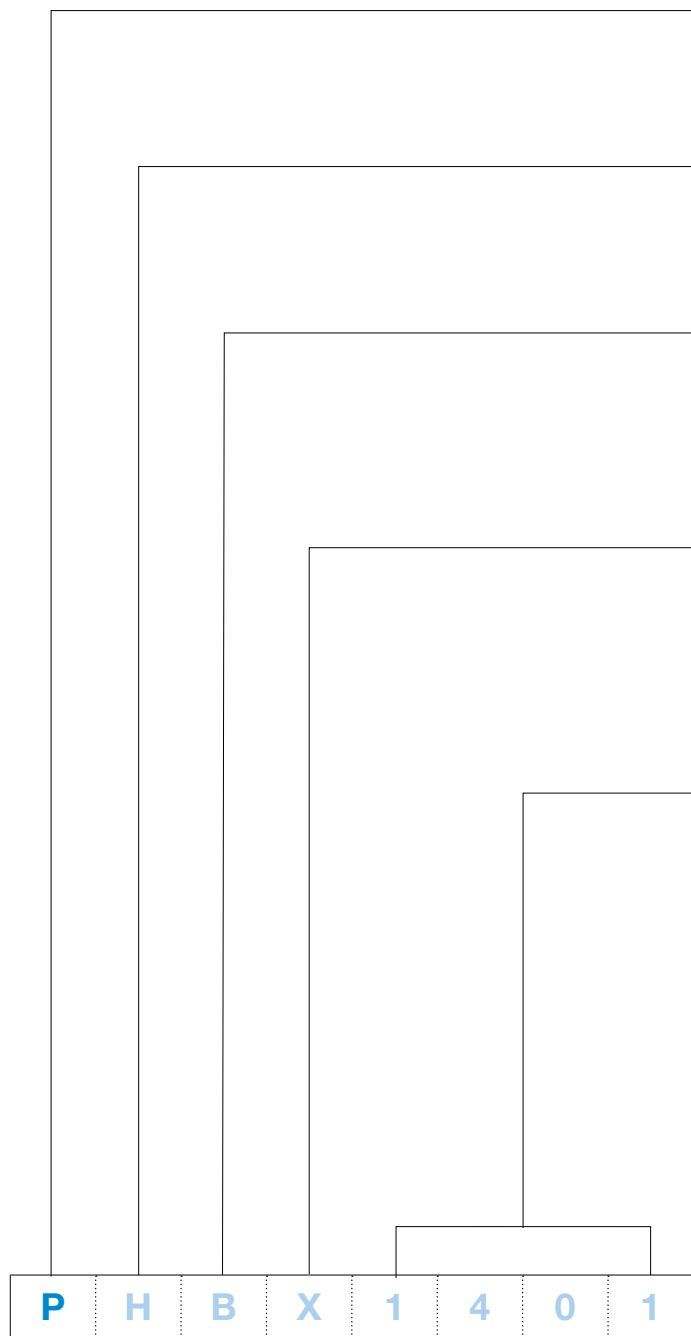

RANGE IDENTIFIER

The first letter of all the codes of the new main distribution switchboard "P" stands for "power". Thus the new product is clearly identified by the same initial used for all new components of ABB's System pro E power

- H = Horizontal
- V = Vertical
- D = DIN-rail
- P = Panel
- K = Kit
- F = Frame

B = 400mm - C = 600mm - D = 800mm - F = 1000mm - G = 1250mm (Compartment width)

- R = Rail
- M = System pro M, Mounting
- O = OT
- P = Panel
- F = Flat
- B = Blind

- X = Tmax XT
- T = Tmax T
- E = Emax 2
- S = Standard, Swing
- F = Front, Fixed
- H = Horizontal
- V = Vertical
- R = Recessed
- B = Blind

Tmax

For Tmax, the first out of the four digits combined with the last letter, gives the breakers type. The second digit refers to the number of poles or side-by-side breakers. The last two digits specify the execution as below indicated.

3 = 3 Poles / 4 = 4/3-4 Poles / 6 = 2 Breakers / 7 = 3 Breakers / 8 = 4 Breakers / 9 = 5 Breakers

00 = W - RHD / 01 = F / 02 = F - I / 03 = F - I-MO / 04 = F - MO
 05 = F - RHD / 06 = F, F - RHD / 07 = P / 09 = P - MO / 10 = W / 11 = W - I-MO / 12 = W - MO / 13 = W, W - I, W - I-MO, W - MO / 14 = W, W - RHD / 17 = W - RC / 18 = F - I, F - I-MO / 19 = F, F - I, F - I-MO, F - MO / 20 = F, F - RHD, F - MO / 22 = F - I, P - I / 23 = F - RC / 24 = F - I-MO, P - I-MO / 25 = W - I / 26 = P, P - RHD / 27 = P - RHD / 28 = P - RC
 29 = F, F - I, F - I-MO, F - MO, F - RHD / 30 = W, W - I, W - I-MO, W - MO, W - RHD / 31 = P - I, P - I-MO / 32 = P - I-MO / 33 = W, W - MO / 36 = W, W - MO / 46 = W / 56 = W - MO

Emax 2

For Emax 2, the first two digits, combined with the last letter, gives the breakers type. The last digit specifies the execution as below indicated.
 3 = 3 Poli / 4 = 4 Poli, 3-4 Poli / 5 = 3 o 3-4 Poli / 6 = 4 Poli, 3-4 Poli cella H=600mm
 0 = W, W - I / 1 = F, F - I / 2 = F / 3 = W / 6 = W

Key:

F	fixed	P	plug-in	W - I	withdrawable interlocked
F - I	fixed interlocked	P - I	plug-in interlocked	W - I-MO	withdrawable interlocked motor-operated
F - I-MO	fixed interlocked motor-operated	P - I-MO	plug-in interlocked motor-operated	W - MO	withdrawable motor-operated
F - MO	fixed motor-operated	P - MO	plug-in motor-operated	W - RC	withdrawable with residual current
F - RC	fixed with residual current	P - RC	plug-in with residual current	W - RHD	withdrawable with direct rotary handle
F - RHD	fixed with direct rotary handle	P - RHD	plug-in with direct rotary handle	W & W - I	withdrawable and withdrawable interlocked
F & F - I	fixed and fixed interlocked	W	withdrawable		

System pro E power

Order codes - Internal kits

3

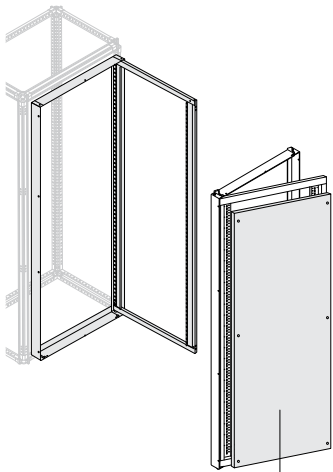
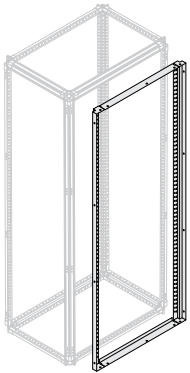

PPFB18..
PPFB20..



PUKI

PCCM....
PCCS....

PUKI

PUCM....
PUCS....

Fixed frame for panels

Fixed frame for internal panels; the useful height of the switchboard can be used to full advantage. With fixed frame for panels, maximum wiring ducts dimension is 60x60mm.

Description	Dimensions (mm)		Order code	ABB code	Package/ No. pcs
	H	W			
Fixed frame for panels	1800	400	PPPF1840	1STQ007449A0000	1/1
Fixed frame for panels	1800	600	PPPF1860	1STQ007450A0000	1/1
Fixed frame for panels	1800	800	PPPF1880	1STQ007451A0000	1/1
Fixed frame for panels	1800	1000	PPPF1810	1STQ007452A0000	1/1
Fixed frame for panels	1800	1250	PPPF1812	1STQ007453A0000	1/1
Fixed frame for panels	2000	400	PPPF2040	1STQ007454A0000	1/1
Fixed frame for panels	2000	600	PPPF2060	1STQ007455A0000	1/1
Fixed frame for panels	2000	800	PPPF2080	1STQ007456A0000	1/1
Fixed frame for panels	2000	1000	PPPF2010	1STQ007457A0000	1/1
Fixed frame for panels	2000	1250	PPPF2012	1STQ007458A0000	1/1

Swing frame for panels and counterdoor application

Swing frame for panels, reduces the available useful space by 100mm. After its opening, it is possible to remove all the internal panels at once or one by one. In structures without intermediate upright, swing frame PFPS... cannot be installed with horizontal busbars at all height. In combination with flat blind panel H=1800mm or H=2000mm operates or counterdoor application.

Description	Dimensions (mm)		Order code	ABB code	Package/ No. pcs
	H	W			
Swing frame for panels	1800	400	PFPS1840	1STQ007459A0000	1/1
Swing frame for panels	1800	600	PFPS1860	1STQ007460A0000	1/1
Swing frame for panels	1800	800	PFPS1880	1STQ007461A0000	1/1
Swing frame for panels	2000	400	PFPS2040	1STQ007462A0000	1/1
Swing frame for panels	2000	600	PFPS2060	1STQ007463A0000	1/1
Swing frame for panels	2000	800	PFPS2080	1STQ007464A0000	1/1

Intermediate upright for internal kit assembly

Intermediate depth upright for assembling kits for Tmax and Emax 2. The intermediate uprights are not required for assembling fixed Tmax XT1, XT2, XT3, XT4, T4, T5, T6 and XT1, XT3 with Direct Rotary Handle only in non-segregated structures. Order 2 uprights for the kits.

Description	Dimensions (mm)		Order code	ABB code	Package/ No. pcs
	H	W			
Intermediate upright for internal kits	1800		PUKI1800	1STQ008039A0000	1/1
Intermediate upright for internal kits	2000		PUKI2000	1STQ008040A0000	1/1

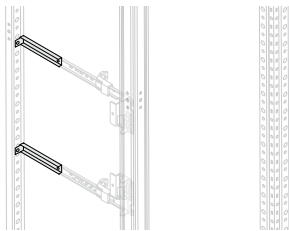

Extension kit for D=300mm structures

To be used as an alternative to the intermediate upright in D=300mm structures. The extension kit PKEK0004 cannot be mounted on the first cell at the top or at the bottom of the enclosure, but a minimum H=50mm space must be left empty from the top or the bottom. It consists of 4 parts that connect the ends of the kit fixing brackets to the structural rear uprights of D=300mm structures.

Description	Order code	ABB code	Package/ No. pcs
Extension kit	PKEK0004	1STQ008198A0000	1/1

Circuit-breakers and busbars that can be installed in D=300mm structures

Only use circuit-breakers with front terminals.

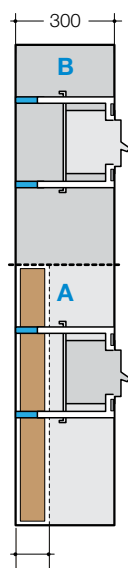

150mm
Maximum encumbrance bars

Circuit-breaker version	XT1	XT2	XT3	XT4	T4	T5	T6	T7	E1.2
Fixed	■	■	■	■	■	■	■	●	●
Fixed with Direct Rotary Handle (RHD)	■	◆	■	◆	●	●	●	●	
Fixed with motor operator (MO)	●	●	●	●	●	●	●	●	
Fixed interlocked	●	●	●	●	●	●	●	●	●
Fixed interlocked motor-operated								●	●
Plug-in	◆	●	◆	●	●	●			
Plug-in with Direct Rotary Handle (RHD)	●	●	●	●	●	●			
Plug-in with motor operator (MO)	●	●	●	●					
Plug-in interlocked	●		●						
Plug-in interlocked motor-operated									
Withdrawable		●		●	●	●	●		
Withdrawable with Direct Rotary Handle (RHD)		●		●	●	●	●		
Withdrawable with motor operator (MO)		●		●					
Withdrawable interlocked									
Withdrawable interlocked motor-operated									

Key

- Circuit-breaker for installation with extension in position B
- Circuit-breaker for installation without extension in position A and B
- ◆ Circuit-breaker for installation with extension in position A and B

Circuit-breakers and busbars that can be installed in D=300mm structures with cable container

Only use circuit-breakers with front terminals.

D=300mm structure and cable container without rear upright

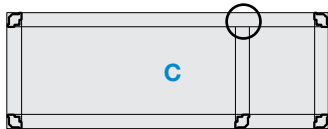

D=300mm structure and cable container without rear upright

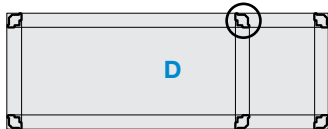

Circuit-breaker version	XT1	XT2	XT3	XT4	T4	T5	T6	T7	E1.2
Fixed	■	■	■	■	■	■	■	●	●
Fixed with Direct Rotary Handle (RHD)	■	●	■	●	●	●	●	●	
Fixed with motor operator (MO)	●	●	●	●	●	●	●	●	
Fixed interlocked	●	●	●	●	●	●	●	●	●
Fixed interlocked motor-operated								●	●
Plug-in	●	●	●	●	●	●			
Plug-in with Direct Rotary Handle (RHD)	●	●	●	●	●	●			
Plug-in with motor operator (MO)	●	●	●	●					
Plug-in interlocked	●		●						
Plug-in interlocked motor-operated									
Withdrawable		●		●	●	●	●		
Withdrawable with Direct Rotary Handle (RHD)		●		●	●	●	●		
Withdrawable with motor operator (MO)		●		●					
Withdrawable interlocked									
Withdrawable interlocked motor-operated									

Key

- Circuit-breaker for installation without extension in C structures
- Circuit-breaker for installation with extension in D structures

System pro E power

Order codes - Internal kits

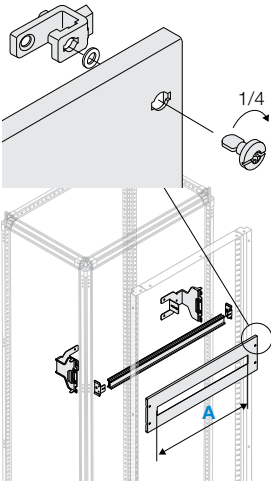

3

N° circuit breakers for each DIN rail

	A (mm)		
	12 mod.	24 mod.	36 mod.
Tmax	210	420	630
XT1 3P	2	5	8
XT1 4P	2	4	6
XT3 3P	2	4	6
XT3 4P	1	3	4

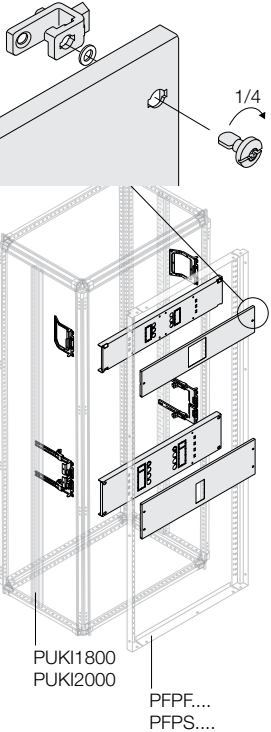

Compatible residual current devices:

Tmax XT

RC Inst. XT1-XT3, RC Sel. XT1-XT3 and RC Sel.. XT2-XT4 Type A. For XT1-XT3 fixed with residual current device high terminal covers are not available.

Tmax T

RC222 for T4 and T5.

Kits for DIN rail

Description	Dimensions (mm) W	Order code	ABB code	Package/ No. pcs
Standard DIN rail	400	PDRS0400	1STQ008041A0000	1/1
Standard DIN rail	600	PDRS0600	1STQ008042A0000	1/1
Standard DIN rail	800	PDRS0800	1STQ008043A0000	1/1

Panels for System Pro-M modular circuit-breakers and Tmax XT1 and Tmax XT3 moulded-case circuit-breakers ⁽¹⁾

Panels with 1/4 turn screws, hinged on the right or the left with the dedicated PHFP0020 kit.

Description	Dimensions (mm)		Order code	ABB code	Package/ No. pcs
	H	W			
Panel with 12 DIN modules	150	400	PPMF1540	1STQ008044A0000	1/1
Panel with 24 DIN modules	150	600	PPMF1560	1STQ008045A0000	1/1
Panel with 36 DIN modules	150	800	PPMF1580	1STQ008046A0000	1/1
Panel with 12 DIN modules	200	400	PPMF2040	1STQ008047A0000	1/1
Panel with 24 DIN modules	200	600	PPMF2060	1STQ008048A0000	1/1
Panel with 36 DIN modules	200	800	PPMF2080	1STQ008049A0000	1/1
Panel with 12x2 DIN modules	300	400	PPMF3040	1STQ008050A0000	1/1
Panel with 24x2 DIN modules	300	600	PPMF3060	1STQ008051A0000	1/1
Panel with 36x2 DIN modules	300	800	PPMF3080	1STQ008052A0000	1/1

⁽¹⁾ The bracket and glossy plate kit can be ordered from the circuit-breaker catalogue. The sole glossy plate is available among the accessories in this catalogue.

Kits for installation of Tmax circuit-breakers

Horizontal installation (front or rear connections)

The kit includes the dedicated fixing brackets, the mounting plate and panels with 1/4 turn screws, hinged on the right or the left with the dedicated PHFP0020 kit.

Tmax	No. poles	Versions	Dimensions H (mm)	No. CB per compartment	Order code	ABB code	Package/No. pcs
12 DIN modules - W=400mm							
XT1	3	F - RC	200	2	PHBX1323	1STQ001442B0000	1/1
XT1	3/4	F	150	1	PHBX1401	1STQ007757A0000	1/1
XT1	3/4	F - RHD	150	1	PHBX1405	1STQ007761A0000	1/1
XT1	3/4	F	200	1	PHBX1101	1STQ008473A0000	1/1
XT1	3/4	F - MO	200	1	PHBX1404	1STQ007759A0000	1/1
XT1	3/4	P	200	1	PHBX1407	1STQ007763A0000	1/1
XT1	3/4	P - MO	200	1	PHBX1409	1STQ007765A0000	1/1
XT1	3/4	P - RHD	200	1	PHBX1427	1STQ007767A0000	1/1
XT1	3/4	F - RHD	200	1	PHBX1105	1STQ008475A0000	1/1
XT1	3/4	F - I	500	2	PHBX1422	1STQ008410A0000	1/1
XT1	3/4	F - I-MO	500	2	PHBX1424	1STQ008411A0000	1/1
XT1	3/4	P - I	500	2	PHBX1422	1STQ008410A0000	1/1
XT1	3/4	P - I-MO	500	2	PHBX1424	1STQ008411A0000	1/1
XT1	4	F - RC	200	1	PHBX1423	1STQ007769A0000	1/1
XT2	3	F	150	1	PHBX2301	1STQ007771A0000	1/1
XT2	3	W	200	1	PHBX2310	1STQ007787A0000	1/1
XT2	3	W - MO	200	1	PHBX2312	1STQ007789A0000	1/1

CONTINUES

> Quick selection guides page 3/4 > Technical details page 7/1 > Overall dimensions page 8/1

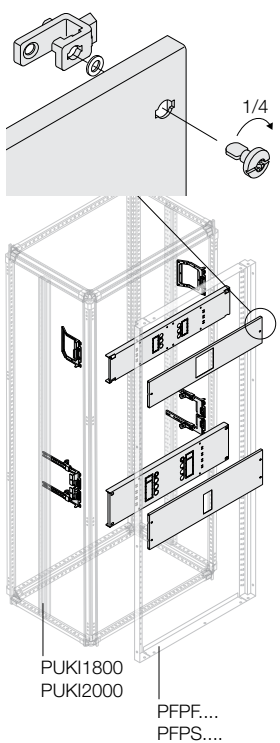

Kits for installation of Tmax circuit-breakers

Horizontal installation (front or rear connections)

The kit includes the dedicated fixing brackets, the mounting plate and panels with 1/4 turn screws, hinged on the right or the left with the dedicated PHFP0020 kit.

Tmax	No. poles	Versions	Dimensions H (mm)	No. CB per compartment	Order code	ABB code	Package/No. pcs
12 DIN modules - W=400mm							
XT2	3	W - RHD	200	1	PHBX2300	1STQ007791A0000	1/1
XT2	3/4	F	200	1	PHBX2401	1STQ007773A0000	1/1
XT2	3/4	F - MO	200	1	PHBX2404	1STQ007775A0000	1/1
XT2	3/4	F - RHD	200	1	PHBX2405	1STQ007779A0000	1/1
XT2	3/4	P	200	1	PHBX2407	1STQ007781A0000	1/1
XT2	4	P - RC	250	1	PHBX2428	1STQ001450B0000	1/1
XT2	3/4	P - MO	200	1	PHBX2409	1STQ007783A0000	1/1
XT2	3/4	P - RHD	200	1	PHBX2427	1STQ007785A0000	1/1
XT2	3/4	W	250	1	PHBX2410	1STQ007793A0000	1/1
XT2	3/4	W - MO	250	1	PHBX2412	1STQ007795A0000	1/1
XT2	3/4	W - RHD	250	1	PHBX2400	1STQ007799A0000	1/1
XT2	3/4	F - I	500	2	PHBX2402	1STQ008412A0000	1/1
XT2	3/4	F - I-MO	500	2	PHBX2424	1STQ008415A0000	1/1
XT2	3/4	P - I	500	2	PHBX2431	1STQ008413A0000	1/1
XT2	3/4	P - I-MO	500	2	PHBX2424	1STQ008415A0000	1/1
XT2	3/4	W - I	500	2	PHBX2425	1STQ008414A0000	1/1
XT2	3/4	W - I-MO	500	2	PHBX2425	1STQ008414A0000	1/1
XT2	4	F - RC	200	1	PHBX2423	1STQ007777A0000	1/1
XT3	3	F	150	1	PHBX3301*	1STQ007801A0000	1/1
XT3	3	F - RHD	150	1	PHBX3305	1STQ007803A0000	1/1
XT3	3/4	F	200	1	PHBX3401*	1STQ007805A0000	1/1
XT3	3/4	F - MO	200	1	PHBX3404	1STQ007807A0000	1/1
XT3	3/4	F - RHD	200	1	PHBX3405	1STQ007809A0000	1/1
XT3	3/4	P	200	1	PHBX3407	1STQ007811A0000	1/1
XT3	3/4	P - MO	200	1	PHBX3409	1STQ007813A0000	1/1
XT3	3/4	P - RHD	200	1	PHBX3427	1STQ007815A0000	1/1
XT3	3/4	F - I	500	2	PHBX3422	1STQ008417A0000	1/1
XT3	3/4	F - I-MO	500	2	PHBX3424	1STQ008418A0000	1/1
XT3	3/4	P - I	500	2	PHBX3422	1STQ008417A0000	1/1
XT3	3/4	P - I-MO	500	2	PHBX3424	1STQ008418A0000	1/1
XT3	4	F - RC	250	1	PHBX3423*	1STQ007817A0000	1/1
XT4	3	F	150	1	PHBX4301*	1STQ007819A0000	1/1
XT4	3/4	F	200	1	PHBX4401*	1STQ007821A0000	1/1
XT4	3/4	F - MO	200	1	PHBX4404	1STQ007823A0000	1/1
XT4	3/4	F - RHD	200	1	PHBX4405	1STQ007827A0000	1/1
XT4	3/4	P	200	1	PHBX4407	1STQ007829A0000	1/1
XT4	4	P - RC	250	1	PHBX4428	1STQ001451B0000	1/1
XT4	3/4	P - MO	200	1	PHBX4409	1STQ007831A0000	1/1
XT4	3/4	P - RHD	200	1	PHBX4427	1STQ007833A0000	1/1

Key:

- F fixed
- F - I fixed interlocked
- F - I-MO fixed interlocked motor-operated
- F - MO fixed motor-operated
- F - RC fixed with residual current
- F - RHD fixed with Direct Rotary Handle
- F & F - I fixed and direct interlocked
- P plug-in
- P - I plug-in interlocked
- P - I-MO plug-in interlocked motor-operated
- P - MO plug-in motor-operated
- P - RC plug-in with residual current
- P - RHD plug-in with Direct Rotary Handle
- W withdrawable
- W - I withdrawable interlocked
- W - I-MO withdrawable interlocked motor-operated
- W - MO withdrawable motor-operated
- W - RC withdrawable with residual current
- W - RHD withdrawable with Direct Rotary Handle
- W & W - I withdrawable and withdrawable interlocked

* Not compatible with high terminal covers.

CONTINUE

Compatible residual current devices:

Tmax XT

RC Inst. XT1-XT3, RC Sel. XT1-XT3 and RC Sel. XT2-XT4 Type A. For XT1-XT3 fixed with residual current device high terminal covers are not available.

Tmax T

RC222 for T4 and T5.

To assemble these kits, order the dedicated intermediate depth uprights PUKI1800 for H= 1800mm or PUKI2000 for H=2000mm. Intermediate uprights are not required for assembling fixed Tmax XT1, XT2, XT3, XT4, T4, T5, T6 and XT1, XT3 with Direct Rotary Handle only in non-segregated structures. Order the dedicated fixed frame PFPF... or swing frame PFPS... for assembling internal panels. For D=300mm structures, consult the details on page 3/21.

For fixed and withdrawable 3P breakers Tmax XT, non accessorized and mounted on 3/4P kit, it is necessary to order the dedicated cover flanges: AD3305 flange for XT1 3P mounted on plate, AD3306 flange for XT2 3P mounted on plate, AD3307 flange for XT3 3P mounted on plate, AD3308 flange for XT4 3P mounted on plate. With interlocked or interlocked motor-operated kits, it is necessary to order the quantity of flanges equal to the quantity of breakers.

System pro E power

Order codes - Internal kits

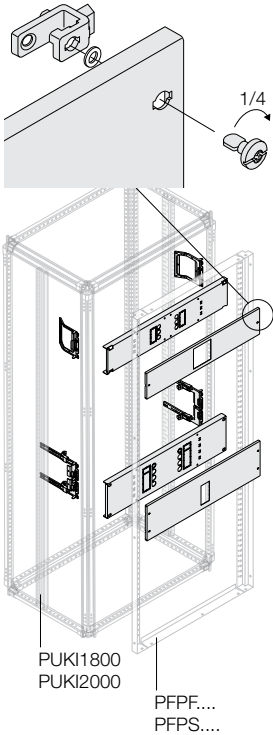

Kits for installation of Tmax circuit-breakers

Horizontal installation (front or rear connections)

The kit includes the dedicated fixing brackets, the mounting plate and panels with 1/4 turn screws, hinged on the right or the left with the dedicated PHFP0020 kit.

Tmax	No. poles	Versions	Dimensions H (mm)	No. CB per compartment	Order code	ABB code	Package/No. pcs
12 DIN modules - W=400mm							
XT4	3/4	W	250	1	PHBX4410	1STQ007835A0000	1/1
XT4	3/4	W - MO	250	1	PHBX4412	1STQ007837A0000	1/1
XT4	3/4	W - RHD	250	1	PHBX4400	1STQ007841A0000	1/1
XT4	3/4	F - I	500	2	PHBX4402	1STQ008419A0000	1/1
XT4	3/4	F - I-MO	500	2	PHBX4424	1STQ008422A0000	1/1
XT4	3/4	P - I	500	2	PHBX4431	1STQ008420A0000	1/1
XT4	3/4	P - I-MO	500	2	PHBX4424	1STQ008422A0000	1/1
XT4	3/4	W - I	500	2	PHBX4425	1STQ008421A0000	1/1
XT4	3/4	W - I-MO	500	2	PHBX4425	1STQ008421A0000	1/1
XT4	4	F - RC	200	1	PHBX4423	1STQ007825A0000	1/1
T4	3	F	150	1	PHBT4301*	1STQ007843A0000	1/1
T4	3/4	F	200	1	PHBT4406*	1STQ007845A0000	1/1
T4	3/4	F - MO	200	1	PHBT4404	1STQ007847A0000	1/1
T4	3/4	F - RHD	200	1	PHBT4406*	1STQ007845A0000	1/1
T4	3/4	F - I	600	2	PHBT4402	1STQ008424A0000	1/1
T5	3	F 400A/630A	200	1	PHBT5306*	1STQ007850A0000	1/1
T5	3	F - MO 400A/630A	200	1	PHBT5304	1STQ007852A0000	1/1
T5	3	F - RHD 400A/630A	200	1	PHBT5306*	1STQ007850A0000	1/1
T5	3	P 400A	200	1	PHBT5326	1STQ007854A0000	1/1
T5	3	P - MO 400A	200	1	PHBT5309	1STQ008406A0000	1/1
T5	3	P - RHD 400A	200	1	PHBT5326	1STQ007854A0000	1/1
T5	3	W 400A	300	1	PHBT5314	1STQ007862A0000	1/1
T5	3	W - MO 400A	300	1	PHBT5312	1STQ008408A0000	1/1
T5	3	W - RHD 400A	300	1	PHBT5314	1STQ007862A0000	1/1
T5	3/4	F 400A/630A	250	1	PHBT5406*	1STQ007856A0000	1/1
T5	3/4	F - MO 400A/630A	250	1	PHBT5404	1STQ007858A0000	1/1
T5	3/4	F - RHD 400A/630A	250	1	PHBT5406*	1STQ007856A0000	1/1
T5	3/4	P 400A	250	1	PHBT5426	1STQ007860A0000	1/1
T5	3/4	P - MO 400A	250	1	PHBT5409	1STQ008407A0000	1/1
T5	3/4	P - RHD 400A	250	1	PHBT5426	1STQ007860A0000	1/1
T5	3/4	W 400A	350	1	PHBT5414	1STQ007864A0000	1/1
T5	3/4	W - MO 400A	350	1	PHBT5412	1STQ008409A0000	1/1
T5	3/4	W - RHD 400A	350	1	PHBT5414	1STQ007864A0000	1/1

Key:

F	fixed
F - I	fixed interlocked
F - I-MO	fixed interlocked motor-operated
F - MO	fixed motor-operated
F - RC	fixed with residual current
F - RHD	fixed with Direct Rotary Handle
F & F - I	fixed and fixed interlocked
P	plug-in
P - I	plug-in interlocked
P - I-MO	plug-in interlocked motor-operated
P - MO	plug-in motor-operated
P - RC	plug-in with residual current
P - RHD	plug-in with Direct Rotary Handle
W	withdrawable
W - I	withdrawable interlocked
W - I-MO	withdrawable interlocked motor-operated
W - MO	withdrawable motor-operated
W - RC	withdrawable with residual current
W - RHD	withdrawable with Direct Rotary Handle
W & W - I	withdrawable and withdrawable interlocked

Compatible residual current devices:

Tmax XT

RC Inst. XT1-XT3, RC Sel. XT1-XT3 and RC Sel.. XT2-XT4 Type A. For XT1-XT3 fixed with residual current device high terminal covers are not available.

Tmax T

RC222 for T4 and T5.

* Not compatible with high terminal covers.

CONTINUES

To assemble these kits, order the dedicated intermediate depth uprights PUKI1800 for H= 1800mm or PUKI2000 for H=2000mm. Intermediate uprights are not required for assembling fixed Tmax XT1, XT2, XT3, XT4, T4, T5, T6 and XT1, XT3 with Direct Rotary Handle only in non-segregated structures. Order the dedicated fixed frame PFPF... or swing frame PFPS... for assembling internal panels. For D=300mm structures, consult the details on page 3/21.

For fixed and withdrawable 3P breakers Tmax XT, non accessorized and mounted on 3/4P kit, it is necessary to order the dedicated cover flanges: AD3305 flange for XT1 3P mounted on plate, AD3306 flange for XT2 3P mounted on plate, AD3307 flange for XT3 3P mounted on plate, AD3308 flange for XT4 3P mounted on plate. With interlocked or interlocked motor-operated kits, it is necessary to order the quantity of flanges equal to the quantity of breakers.

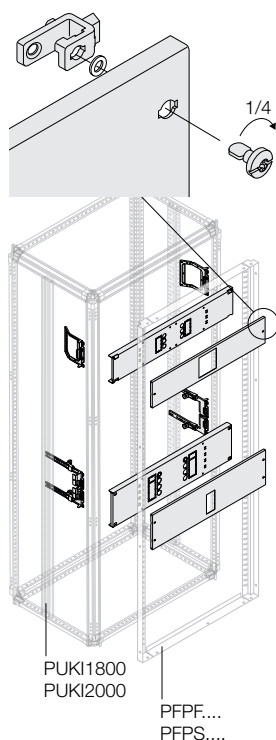

Kits for installation of Tmax circuit-breakers

Horizontal installation (front or rear connections)

The kit includes the dedicated fixing brackets, the mounting plate and panels with 1/4 turn screws, hinged on the right or the left with the dedicated PHFP0020 kit.

Tmax	No. poles	Version	Dimensions H (mm)	No. CB per compartment	Order code	ABB code	Package/No. pcs
24 moduli DIN - L=600mm							
XT1	3/4	F	200	1	PHCX1101	1STQ008474A0000	1/1
XT1	3	F - RC	200	1	PHCX1323	1STQ001443B0000	1/1
XT1	3/4	F	150	1	PHCX1401	1STQ007758A0000	1/1
XT1	3/4	F - RHD	150	1	PHCX1405	1STQ007762A0000	1/1
XT1	3/4	F - RHD	200	1	PHCX1105	1STQ008476A0000	1/1
XT1	3/4	F - MO	200	1	PHCX1404	1STQ007760A0000	1/1
XT1	3/4	P	200	1	PHCX1407	1STQ007764A0000	1/1
XT1	3/4	P - MO	200	1	PHCX1409	1STQ007766A0000	1/1
XT1	3/4	P - RHD	200	1	PHCX1427	1STQ007768A0000	1/1
XT1	3/4	F - I	500	2	PHCX1422	1STQ008432A0000	1/1
XT1	3/4	F - I-MO	500	2	PHCX1424	1STQ008433A0000	1/1
XT1	3/4	P - I	500	2	PHCX1422	1STQ008432A0000	1/1
XT1	3/4	P - I-MO	500	2	PHCX1424	1STQ008433A0000	1/1
XT1	4	F - RC	200	1	PHCX1423	1STQ007770A0000	1/1
XT2	3	F	150	1	PHCX2301	1STQ007772A0000	1/1
XT2	3	W	200	1	PHCX2310	1STQ007788A0000	1/1
XT2	3	W - MO	200	1	PHCX2312	1STQ007790A0000	1/1
XT2	3	W - RHD	200	1	PHCX2300	1STQ007792A0000	1/1
XT2	3/4	F	200	1	PHCX2401	1STQ007774A0000	1/1
XT2	3/4	F - MO	200	1	PHCX2404	1STQ007776A0000	1/1
XT2	3/4	F - RHD	200	1	PHCX2405	1STQ007780A0000	1/1
XT2	3/4	P	200	1	PHCX2407	1STQ007782A0000	1/1
XT2	3/4	P - MO	200	1	PHCX2409	1STQ007784A0000	1/1
XT2	3/4	P - RHD	200	1	PHCX2427	1STQ007786A0000	1/1
XT2	3/4	W	250	1	PHCX2410	1STQ007794A0000	1/1
XT2	3/4	W - MO	250	1	PHCX2412	1STQ007796A0000	1/1
XT2	3/4	W - RHD	250	1	PHCX2400	1STQ007800A0000	1/1
XT2	3/4	F - I	500	2	PHCX2402	1STQ008434A0000	1/1
XT2	3/4	F - I-MO	500	2	PHCX2424	1STQ008437A0000	1/1
XT2	3/4	P - I	500	2	PHCX2431	1STQ008435A0000	1/1
XT2	3/4	P - I-MO	500	2	PHCX2424	1STQ008437A0000	1/1
XT2	3/4	W - I	500	2	PHCX2425	1STQ008436A0000	1/1
XT2	3/4	W - I-MO	500	2	PHCX2425	1STQ008436A0000	1/1
XT2	4	F - RC	200	1	PHCX2423	1STQ007778A0000	1/1
XT2	4	W - RC	250	1	PHCX2417	1STQ007798A0000	1/1
XT3	3	F	150	1	PHCX3301	1STQ007802A0000	1/1
XT3	3	F - RHD	150	1	PHCX3305	1STQ007804A0000	1/1
XT3	3/4	F	200	1	PHCX3401	1STQ007806A0000	1/1
XT3	3/4	F - MO	200	1	PHCX3404	1STQ007808A0000	1/1

Compatible residual current devices:

Tmax XT

RC Inst. XT1-XT3, RC Sel. XT1-XT3 and RC Sel. XT2-XT4 Type A. For XT1-XT3 fixed with residual current device high terminal covers are not available.

Tmax T

RC222 for T4 and T5.

To assemble these kits, order the dedicated intermediate depth uprights PUKI1800 for H= 1800mm or PUKI2000 for H=2000mm. Intermediate uprights are not required for assembling fixed Tmax XT1, XT2, XT3, XT4, T4, T5, T6 and XT1, XT3 with Direct Rotary Handle only in non-segregated structures. Order the dedicated fixed frame PFPF... or swing frame PFPS... for assembling internal panels. For D=300mm structures, consult the details on page 3/21.

For fixed and withdrawable 3P breakers Tmax XT, non accessorized and mounted on 3/4P kit, it is necessary to order the dedicated cover flanges: AD3305 flange for XT1 3P mounted on plate, AD3306 flange for XT2 3P mounted on plate, AD3307 flange for XT3 3P mounted on plate, AD3308 flange for XT4 3P mounted on plate. With interlocked or interlocked motor-operated kits, it is necessary to order the quantity of flanges equal to the quantity of breakers.

CONTINUES

System pro E power

Order codes - Internal kits

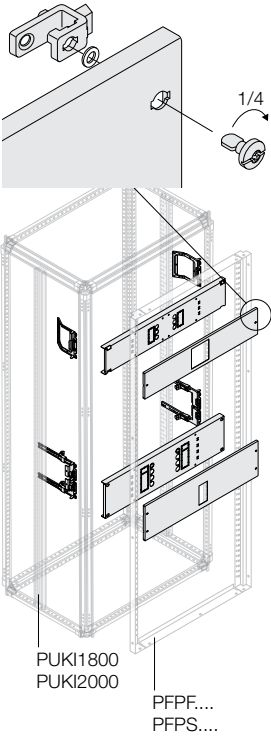

Kits for installation of Tmax circuit-breakers

Horizontal installation (front or rear connections)

The kit includes the dedicated fixing brackets, the mounting plate and panels with 1/4 turn screws, hinged on the right or the left with the dedicated PHFP0020 kit.

Tmax	No. poles	Version	Dimensions H (mm)	No. CB per compartment	Order code	ABB code	Package/No. pcs
24 DIN modules - W=600mm							
XT3	3/4	F - RHD	200	1	PHCX3405	1STQ007810A0000	1/1
XT3	3/4	P	200	1	PHCX3407	1STQ007812A0000	1/1
XT3	3/4	P - MO	200	1	PHCX3409	1STQ007814A0000	1/1
XT3	3/4	P - RHD	200	1	PHCX3427	1STQ007816A0000	1/1
XT3	3/4	F - I	500	2	PHCX3422	1STQ008439A0000	1/1
XT3	3/4	F - I-MO	500	2	PHCX3424	1STQ008440A0000	1/1
XT3	3/4	P - I	500	2	PHCX3422	1STQ008439A0000	1/1
XT3	3/4	P - I-MO	500	2	PHCX3424	1STQ008440A0000	1/1
XT3	4	F - RC	250	1	PHCX3423	1STQ007818A0000	1/1
XT4	3	F	150	1	PHCX4301	1STQ007820A0000	1/1
XT4	3/4	F	200	1	PHCX4401	1STQ007822A0000	1/1
XT4	3/4	F - MO	200	1	PHCX4404	1STQ007824A0000	1/1
XT4	3/4	F - RHD	200	1	PHCX4405	1STQ007828A0000	1/1
XT4	3/4	P	200	1	PHCX4407	1STQ007830A0000	1/1
XT4	3/4	P - MO	200	1	PHCX4409	1STQ007832A0000	1/1
XT4	3/4	P - RHD	200	1	PHCX4427	1STQ007834A0000	1/1
XT4	3/4	W	250	1	PHCX4410	1STQ007836A0000	1/1
XT4	3/4	W - MO	250	1	PHCX4412	1STQ007838A0000	1/1
XT4	3/4	W - RHD	250	1	PHCX4400	1STQ007842A0000	1/1
XT4	3/4	F - I	500	2	PHCX4402	1STQ008441A0000	1/1
XT4	3/4	F - I-MO	500	2	PHCX4424	1STQ008444A0000	1/1
XT4	3/4	P - I	500	2	PHCX4431	1STQ008442A0000	1/1
XT4	3/4	P - I-MO	500	2	PHCX4424	1STQ008444A0000	1/1
XT4	3/4	W - I	500	2	PHCX4425	1STQ008443A0000	1/1
XT4	3/4	W - I-MO	500	2	PHCX4425	1STQ008443A0000	1/1
XT4	4	F - RC	200	1	PHCX4423	1STQ007826A0000	1/1
XT4	4	W - RC	250	1	PHCX4417	1STQ007840A0000	1/1
T4	3	F	150	1	PHCT4301	1STQ007844A0000	1/1
T4	3/4	F	200	1	PHCT4406	1STQ007846A0000	1/1
T4	3/4	F - MO	200	1	PHCT4404	1STQ007848A0000	1/1
T4	3/4	F - RHD	200	1	PHCT4406	1STQ007846A0000	1/1
T4	3/4	F - I	600	2	PHCT4402	1STQ008446A0000	1/1
T4	3/4	F - I-MO	600	2	PHCT4403	1STQ008447A0000	1/1
T4	4	F - RC	200	1	PHCT4423	1STQ007849A0000	1/1
T5	3	F 400A/630A	200	1	PHCT5306	1STQ007851A0000	1/1
T5	3	F - MO 400A/630A	200	1	PHCT5304	1STQ007853A0000	1/1
T5	3	F - RHD 400A/630A	200	1	PHCT5306	1STQ007851A0000	1/1
T5	3	P 400A	200	1	PHCT5326	1STQ007855A0000	1/1
T5	3P	P - MO 400A	200	1	PHCT5309	1STQ008428A0000	1/1
T5	3	P - RHD 400A	200	1	PHCT5326	1STQ007855A0000	1/1
T5	3	W 400A	300	1	PHCT5314	1STQ007863A0000	1/1
T5	3P	W - MO 400A	300	1	PHCT5312	1STQ008430A0000	1/1

Key:

- F fixed
- F - I fixed interlocked
- F - I-MO fixed interlocked motor-operated
- F - MO fixed motor-operated
- F - RC fixed with residual current
- F - RHD fixed with Direct Rotary Handle
- F & F - I fixed and fixed interlocked
- P plug-in
- P - I plug-in interlocked
- P - I-MO plug-in interlocked motor-operated
- P - MO plug-in motor-operated
- P - RC plug-in with residual current
- P - RHD plug-in with Direct Rotary Handle
- W withdrawable
- W - I withdrawable interlocked
- W - I-MO withdrawable interlocked motor-operated
- W - MO withdrawable motor-operated
- W - RC withdrawable with residual current
- W - RHD withdrawable with Direct Rotary Handle
- W & W - I withdrawable and withdrawable interlocked

Compatible residual current devices:

Tmax XT

RC Inst. XT1-XT3, RC Sel. XT1-XT3 and RC Sel.. XT2-XT4 Type A. For XT1-XT3 fixed with residual current device high terminal covers are not available.

Tmax T

RC222 for T4 and T5.

To assemble these kits, order the dedicated intermediate depth uprights PUKI1800 for H= 1800mm or PUKI2000 for H=2000mm. Intermediate uprights are not required for assembling fixed Tmax XT1, XT2, XT3, XT4, T4, T5, T6 and XT1, XT3 with Direct Rotary Handle only in non-segregated structures. Order the dedicated fixed frame PFPF... or swing frame PFPS... for assembling internal panels. For D=300mm structures, consult the details on page 3/21. For fixed and withdrawable 3P breakers Tmax XT, non accessorized and mounted on 3/4P kit, it is necessary to order the dedicated cover flanges: AD3305 flange for XT1 3P mounted on plate, AD3306 flange for XT2 3P mounted on plate, AD3307 flange for XT3 3P mounted on plate, AD3308 flange for XT4 3P mounted on plate. With interlocked or interlocked motor-operated kits, it is necessary to order the quantity of flanges equal to the quantity of breakers.

CONTINUES

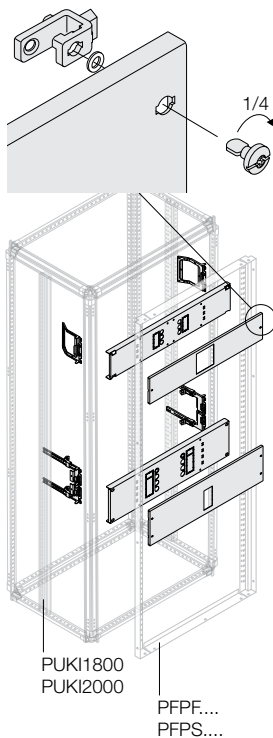

Kits for installation of Tmax circuit-breakers

Horizontal installation (front or rear connections)

The kit includes the dedicated fixing brackets, the mounting plate and panels with 1/4 turn screws, hinged on the right or the left with the dedicated PHFP0020 kit.

Tmax	No. poles	Version	Dimensions H (mm)	No. CB per compartment	Order code	ABB code	Package/No. pcs
24 DIN modules - W=600mm							
T5	3	W - RHD 400A	300	1	PHCT5314	1STQ007863A0000	1/1
T5	3/4	F 400A/630A	250	1	PHCT5406	1STQ007857A0000	1/1
T5	3/4	F - MO 400A/630A	250	1	PHCT5404	1STQ007859A0000	1/1
T5	3/4	F - RHD 400A/630A	250	1	PHCT5406	1STQ007857A0000	1/1
T5	3/4	P 400A	250	1	PHCT5426	1STQ007861A0000	1/1
T5	3/4	P - MO 400A	250	1	PHCT5409	1STQ008429A0000	1/1
T5	3/4	P - RHD 400A	250	1	PHCT5426	1STQ007861A0000	1/1
T5	3/4	W 400A	350	1	PHCT5414	1STQ007865A0000	1/1
T5	3/4	W - MO 400A	350	1	PHCT5412	1STQ008431A0000	1/1
T5	3/4	W - RHD 400A	350	1	PHCT5414	1STQ007865A0000	1/1
T5	3/4	F - I 400A/630A	600	2	PHCT5402	1STQ007868A0000	1/1
T5	3/4	F - I-MO 400A/630A	600	2	PHCT5403	1STQ008448A0000	1/1
T5	3/4	P - I 400A	600	2	PHCT5431	1STQ008449A0000	1/1
T5	3/4	P - I-MO 400A	600	2	PHCT5432	1STQ008450A0000	1/1
T5	3/4	W - I 400A	600	2	PHCT5425	1STQ008451A0000	1/1
T5	3/4	W - I-MO 400A	600	2	PHCT5411	1STQ008452A0000	1/1
T5	3/4	F - I 400A/630A	600	2	PHCT5402	1STQ007868A0000	1/1
T5	4	F - RC	250	1	PHCT5423	1STQ007866A0000	1/1
T6	3	F	300	1	PHCT6301	1STQ007877A0000	1/1
T6	3	F - MO	300	1	PHCT6304	1STQ007879A0000	1/1
T6	3	F - RHD	300	1	PHCT6305	1STQ007881A0000	1/1
T6	3	W	350	1	PHCT6314	1STQ007891A0000	1/1
T6	3	W - MO	350	1	PHCT6312	1STQ007889A0000	1/1
T6	3	W - RHD	350	1	PHCT6314	1STQ007891A0000	1/1
T6	3/4	F	350	1	PHCT6401	1STQ007883A0000	1/1
T6	3/4	F - MO	350	1	PHCT6404	1STQ007885A0000	1/1
T6	3/4	F - RHD	350	1	PHCT6405	1STQ007887A0000	1/1
T6	3/4	W	500	1	PHCT6410	1STQ007893A0000	1/1
T6	3/4	W - MO	500	1	PHCT6412	1STQ007894A0000	1/1
T6	3/4	W - RHD	500	1	PHCT6400	1STQ007896A0000	1/1
T6	3/4	F - I	700	2	PHCT6402	1STQ008453A0000	1/1
T6	3/4	F - I-MO	700	2	PHCT6403	1STQ008454A0000	1/1
T6	3/4	W - I	700	2	PHCT6425	1STQ008167A0000	1/1
T6	3/4	W - I-MO	700	2	PHCT6411	1STQ008456A0000	1/1
T7	3	F	300	1	PHCT7329	1STQ007898A0000	1/1
T7	3	F - I	300	1	PHCT7329	1STQ007898A0000	1/1
T7	3	F - I-MO	300	1	PHCT7329	1STQ007898A0000	1/1
T7	3	F - MO	300	1	PHCT7329	1STQ007898A0000	1/1
T7	3	F - RHD	300	1	PHCT7329	1STQ007898A0000	1/1
T7	3/4	F	350	1	PHCT7420	1STQ007899A0000	1/1
T7	3/4	F - MO	350	1	PHCT7420	1STQ007899A0000	1/1
T7	3/4	F - RHD	350	1	PHCT7420	1STQ007899A0000	1/1
T7	3/4	F - I	400	1	PHCT7418	1STQ007900A0000	1/1
T7	3/4	F - I-MO	400	1	PHCT7418	1STQ007900A0000	1/1
T7	3/4	W	500	1	PHCT7430	1STQ007902A0000	1/1
T7	3/4	W - I	500	1	PHCT7430	1STQ007902A0000	1/1
T7	3/4	W - I-MO	500	1	PHCT7430	1STQ007902A0000	1/1
T7	3/4	W - MO	500	1	PHCT7430	1STQ007902A0000	1/1
T7	3/4	W - RHD	500	1	PHCT7430	1STQ007902A0000	1/1

Key:

- F fixed
- F - I fixed interlocked
- F - I-MO fixed interlocked motor-operated
- F - MO fixed motor-operated
- F - RC fixed with residual current
- F - RHD fixed with Direct Rotary Handle
- F & F - I fixed and fixed interlocked
- P plug-in
- P - I plug-in interlocked
- P - I-MO plug-in interlocked motor-operated
- P - MO plug-in motor-operated
- P - RC plug-in with residual current
- P - RHD plug-in with Direct Rotary Handle
- W withdrawable
- W - I withdrawable interlocked
- W - I-MO withdrawable interlocked motor-operated
- W - MO withdrawable motor-operated
- W - RC withdrawable with residual current
- W - RHD withdrawable with Direct Rotary Handle
- W & W - I withdrawable and withdrawable interlocked

Compatible residual current devices:

Tmax XT

RC Inst. XT1-XT3, RC Sel. XT1-XT3 and RC Sel. XT2-XT4 Type A. For XT1-XT3 fixed with residual current device high terminal covers are not available.

Tmax T

RC222 for T4 and T5.

- Front terminals, only Form 1
- * Only rear terminals

To assemble these kits, order the dedicated intermediate depth uprights PUKI1800 for H= 1800mm or PUKI2000 for H=2000mm. Intermediate uprights are not required for assembling fixed Tmax XT1, XT2, XT3, XT4, T4, T5, T6 and XT1, XT3 with Direct Rotary Handle only in non-segregated structures. Order the dedicated fixed frame PFPF... or swing frame PFPS... for assembling internal panels. For D=300mm structures, consult the details on page 3/21. For fixed and withdrawable 3P breakers Tmax XT, non accessorized and mounted on 3/4P kit, it is necessary to order the dedicated cover flanges: AD3305 flange for XT1 3P mounted on plate, AD3306 flange for XT2 3P mounted on plate, AD3307 flange for XT3 3P mounted on plate, AD3308 flange for XT4 3P mounted on plate. With interlocked or interlocked motor-operated kits, it is necessary to order the quantity of flanges equal to the quantity of breakers.

CONTINUES

System pro E power

Order codes - Internal kits

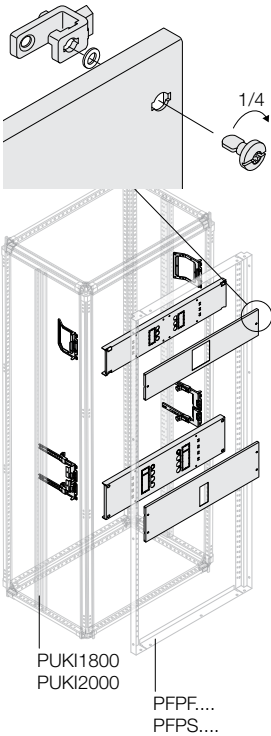

Kits for installation of Tmax circuit-breakers

Horizontal installation (front or rear connections)

The kit includes the dedicated fixing brackets, the mounting plate and panels with 1/4 turn screws, hinged on the right or the left with the dedicated PHFP0020 kit.

Tmax	No. poles	Version	Dimensions H (mm)	No. CB per compartment	Order code	ABB code	Package/No. pcs
36 DIN modules - W=800mm							
XT1	4	F - RC	200	1	PHDX1423	1STQ001472B0000	1/1
XT2	3/4	F	200	1	PHDX2401	1STQ001444B0000	1/1
XT2	3/4	F - MO	200	1	PHDX2404	1STQ001445B0000	1/1
XT2	4	F - RC	200	1	PHDX2423	1STQ001446B0000	1/1
XT2	4	P - RC	250	1	PHDX2428	1STQ001464B0000	1/1
XT3	4	F - RC	200	1	PHDX3423	1STQ001473B0000	1/1
XT4	3/4	F	200	1	PHDX4401	1STQ001447B0000	1/1
XT4	3/4	F - MO	200	1	PHDX4404	1STQ001448B0000	1/1
XT4	4	F - RC	200	1	PHDX4423	1STQ001449B0000	1/1
XT4	4	P - RC	250	1	PHDX4428	1STQ001451B0000	1/1
T4	3/4	F - I	600	2	PHDT4402	1STQ008463A0000	1/1
T4	3/4	F - I-MO	600	2	PHDT4403	1STQ008464A0000	1/1
T5	3	F 400A/630A	200	1	PHDT5306	1STQ007869A0000	1/1
T5	3	F - MO 400A/630A	200	1	PHDT5304	1STQ007870A0000	1/1
T5	3	F - RHD 400A/630A	200	1	PHDT5306	1STQ007869A0000	1/1
T5	3P	P - MO 400A	200	1	PHDT5309	1STQ008457A0000	1/1
T5	3	P 400A	200	1	PHDT5326	1STQ007871A0000	1/1
T5	3P	P - MO 400A	200	1	PHDT5309	1STQ008457A0000	1/1
T5	3	P - RHD 400A	200	1	PHDT5326	1STQ007871A0000	1/1
T5	3	W 400A	300	1	PHDT5314	1STQ007875A0000	1/1
T5	3P	W - MO 400A	300	1	PHDT5312	1STQ008459A0000	1/1
T5	3	W - RHD 400A	300	1	PHDT5314	1STQ007875A0000	1/1
T5	3/4	F 400A/630A	250	1	PHDT5406	1STQ007872A0000	1/1
T5	3/4	F - MO 400A/630A	250	1	PHDT5404	1STQ007873A0000	1/1
T5	3/4	F - RHD 400A/630A	250	1	PHDT5406	1STQ007872A0000	1/1
T5	3/4	P 400A	250	1	PHDT5426	1STQ007874A0000	1/1
T5	3/4	P - MO 400A	250	1	PHDT5409	1STQ008458A0000	1/1
T5	3/4	P - RHD 400A	250	1	PHDT5426	1STQ007874A0000	1/1
T5	3/4	W 400A	350	1	PHDT5414	1STQ007876A0000	1/1
T5	3/4	W - MO 400A	350	1	PHDT5412	1STQ008460A0000	1/1
T5	3/4	W - RHD 400A	350	1	PHDT5414	1STQ007876A0000	1/1
T5	3/4	W - I 400A	600	1	PHDT5425	1STQ008461A0000	1/1
T5	3/4	W - I - MO 400A	600	1	PHDT5411	1STQ008462A0000	1/1
T5	4	F - RC 400A	250	1	PHDT5423	1STQ007867A0000	1/1
T5	4	F - RC	250	1	PHDT5423	1STQ007867A0000	1/1
T6	3	F	300	1	PHDT6301	1STQ007878A0000	1/1
T6	3	F - MO	300	1	PHDT6304	1STQ007880A0000	1/1
T6	3	F - RHD	300	1	PHDT6305	1STQ007882A0000	1/1
T6	3	W	350	1	PHDT6314	1STQ007892A0000	1/1
T6	3	W - MO	350	1	PHDT6312	1STQ007890A0000	1/1
T6	3	W - RHD	350	1	PHDT6314	1STQ007892A0000	1/1
T6	3/4	F	350	1	PHDT6401	1STQ007884A0000	1/1
T6	3/4	F - MO	350	1	PHDT6404	1STQ007886A0000	1/1

Key:

- F fixed
- F - I fixed interlocked
- F - I-MO fixed interlocked motor-operated
- F - MO fixed motor-operated
- F - RC fixed with residual current
- F - RHD fixed with Direct Rotary Handle
- F & F - I fixed and fixed interlocked
- P plug-in
- P - I plug-in interlocked
- P - I-MO plug-in interlocked motor-operated
- P - MO plug-in motor-operated
- P - RC plug-in with residual current
- P - RHD plug-in with Direct Rotary Handle
- W withdrawable
- W - I withdrawable interlocked
- W - I-MO withdrawable interlocked motor-operated
- W - MO withdrawable motor-operated
- W - RC withdrawable with residual current
- W - RHD withdrawable with Direct Rotary Handle
- W & W - I withdrawable and withdrawable interlocked

Compatible residual current devices:

Tmax XT

RC Inst. XT1-XT3, RC Sel. XT1-XT3 and RC Sel. XT2-XT4 Type A. For XT1-XT3 fixed with residual current device high terminal covers are not available.

Tmax T

RC222 for T4 and T5.

■ Front terminals, only Form 1

CONTINUES

To assemble these kits, order the dedicated intermediate depth uprights PUKI1800 for H= 1800mm or PUKI2000 for H=2000mm. Intermediate uprights are not required for assembling fixed Tmax XT1, XT2, XT3, XT4, T4, T5, T6 and XT1, XT3 with Direct Rotary Handle only in non-segregated structures. Order the dedicated fixed frame PFPF... or swing frame PFPS... for assembling internal panels. For D=300mm structures, consult the details on page 3/21. For fixed and withdrawable 3P breakers Tmax XT, non accessorized and mounted on 3/4P kit, it is necessary to order the dedicated cover flanges: AD3305 flange for XT1 3P mounted on plate, AD3306 flange for XT2 3P mounted on plate, AD3307 flange for XT3 3P mounted on plate, AD3308 flange for XT4 3P mounted on plate. With interlocked or interlocked motor-operated kits, it is necessary to order the quantity of flanges equal to the quantity of breakers.

Key:

F	fixed
F - I	fixed interlocked
F - I-MO	fixed interlocked motor-operated
F - MO	fixed motor-operated
F - RC	fixed with residual current
F - RHD	fixed with Direct Rotary Handle
F & F - I	fixed and fixed interlocked
P	plug-in
P - I	plug-in interlocked
P - I-MO	plug-in interlocked motor-operated
P - MO	plug-in motor-operated
P - RC	plug-in with residual current
P - RHD	plug-in with Direct Rotary Handle
W	withdrawable
W - I	withdrawable interlocked
W - I-MO	withdrawable interlocked motor-operated
W - MO	withdrawable motor-operated
W - RC	withdrawable with residual current
W - RHD	withdrawable with Direct Rotary Handle
W & W - I	withdrawable and withdrawable interlocked

Compatible residual current devices:

Tmax XT

RC Inst. XT1-XT3, RC Sel. XT1-XT3 and RC Sel. XT2-XT4 Type A. For XT1-XT3 fixed with residual current device high terminal covers are not available.

Tmax T

RC222 for T4 and T5.

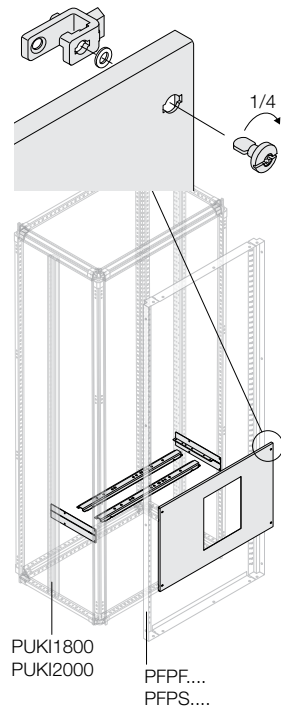

Key:

F	fixed
F - I	fixed interlocked
W	withdrawable
W - I	withdrawable interlocked

Kits for installation of Tmax circuit-breakers

Horizontal installation (front or rear connections)

The kit includes the dedicated fixing brackets, the mounting plate and panels with 1/4 turn screws, hinged on the right or the left with the dedicated PHFP0020 kit.

Tmax	No. poles	Version	Dimensions H (mm)	No. CB per compartment	Order code	ABB code	Package/No. pcs
36 DIN modules - W=800mm							
T6	3/4	F - RHD	350	1	PHDT6405	1STQ007888A0000	1/1
T6	3/4	W	500	1	PHDT6414	1STQ007897A0000	1/1
T6	3/4	W - MO	500	1	PHDT6412	1STQ007895A0000	1/1
T6	3/4	W - RHD	500	1	PHDT6414	1STQ007897A0000	1/1
T7	3	F	300	1	PHDT7329	1STQ007903A0000	1/1
T7	3	F - I	300	1	PHDT7329	1STQ007903A0000	1/1
T7	3	F - I-MO	300	1	PHDT7329	1STQ007903A0000	1/1
T7	3	F - MO	300	1	PHDT7329	1STQ007903A0000	1/1
T7	3	F - RHD	300	1	PHDT7329	1STQ007903A0000	1/1
T7	3/4	F	350	1	PHDT7420	1STQ007904A0000	1/1
T7	3/4	F - MO	350	1	PHDT7420	1STQ007904A0000	1/1
T7	3/4	F - RHD	350	1	PHDT7420	1STQ007904A0000	1/1
T7	3/4	F - I	400	1	PHDT7418	1STQ007905A0000	1/1
T7	3/4	F - I-MO	400	1	PHDT7418	1STQ007905A0000	1/1
T7	3/4	W	500	1	PHDT7430	1STQ007907A0000	1/1
T7	3/4	W - I	500	1	PHDT7430	1STQ007907A0000	1/1
T7	3/4	W - I-MO	500	1	PHDT7430	1STQ007907A0000	1/1
T7	3/4	W - MO	500	1	PHDT7430	1STQ007907A0000	1/1
T7	3/4	W - RHD	500	1	PHDT7430	1STQ007907A0000	1/1

■ Front terminals, only Form 1
* Only rear terminals

To assemble these kits, order the dedicated intermediate depth uprights PUK1800 for H= 1800mm or PUK2000 for H=2000mm. Intermediate uprights are not required for assembling fixed Tmax XT1, XT2, XT3, XT4, T4, T5, T6 and XT1, XT3 with Direct Rotary Handle only in non-segregated structures. Order the dedicated fixed frame PFPF... or swing frame PFPS... for assembling internal panels. For D=300mm structures, consult the details on page 3/21.

For fixed and withdrawable 3P breakers Tmax XT, non accessorized and mounted on 3/4P kit, it is necessary to order the dedicated cover flanges: AD3305 flange for XT1 3P mounted on plate, AD3306 flange for XT2 3P mounted on plate, AD3307 flange for XT3 3P mounted on plate, AD3308 flange for XT4 3P mounted on plate. With interlocked or interlocked motor-operated kits, it is necessary to order the quantity of flanges equal to the quantity of breakers.

Kits for installation of Emax 2 circuit-breakers

Horizontal installation (front or rear connections)

The kit includes the dedicated fixing brackets, the mounting plate and panels with 1/4 turn screws, hinged on the right or the left with the dedicated PHFP0020 kit.

Emax	No. poles	Version	Dimensions H (mm)	No. CB per compartment	Order code	ABB code	Package/No. pcs
24 DIN modules - W=600mm							
E1.2	3/4	F	400	1	PHCE1241	1STQ008151A0000	1/1
E1.2	3/4	F - I	400	1	PHCE1241	1STQ008151A0000	1/1
E1.2	3/4	W	500	1	PHCE1240	1STQ008164A0000	1/1
E1.2	3/4	W - I	500	1	PHCE1240	1STQ008164A0000	1/1
36 DIN modules - W=800mm							
E1.2	3/4	F	400	1	PHDE1241	1STQ008150A0000	1/1
E1.2	3/4	F - I	400	1	PHDE1241	1STQ008150A0000	1/1
E1.2	3/4	W	500	1	PHDE1240	1STQ008386A0000	1/1
E1.2	3/4	W - I	500	1	PHDE1240	1STQ008386A0000	1/1

* Only rear terminals

To assemble these kits, order the dedicated intermediate depth uprights PUK1800 for H= 1800mm or PUK2000 for H=2000mm. Order the dedicated fixed frame PFPF... or swing frame PFPS... for assembling internal panels.

System pro E power

Order codes - Internal kits

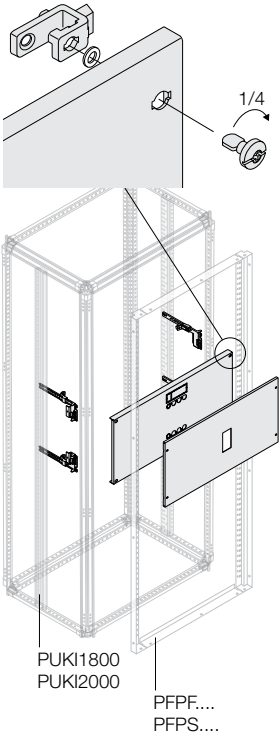

Kits for installation of Tmax circuit-breakers

Vertical installation (front or rear connections)

The kit includes the dedicated fixing brackets, the mounting plate and panels with 1/4 turn screws, hinged on the right or the left with the dedicated PHFP0020 kit.

Tmax	No. poles	Version	Dimensions H (mm)	No. CB per compartment	Order code	ABB code	Package/No. pcs
12 DIN modules - W=400mm							
XT1	3/4	F	300	1	PVBX1401	1STQ007908A0000	1/1
XT1	3/4	F - MO	300	1	PVBX1404	1STQ008465A0000	1/1
XT1	3/4	F - RHD	300	1	PVBX1405	1STQ007912A0000	1/1
XT1	3/4	P	300	1	PVBX1407	1STQ007914A0000	1/1
XT1	3/4	P - MO	300	1	PVBX1409	1STQ007916A0000	1/1
XT1	3/4	P - RHD	300	1	PVBX1427	1STQ007918A0000	1/1
XT1	4	F - RC	300	1	PVBX1423	1STQ007910A0000	1/1
XT1	3/4	F - MO	300	1	PVBX1404	1STQ008465A0000	1/1
XT2	3/4	F - MO	300	1	PVBX2404	1STQ008466A0000	1/1
XT2	3/4	F	300	1	PVBX2401	1STQ007921A0000	1/1
XT2	3/4	F - RHD	300	1	PVBX2405	1STQ007925A0000	1/1
XT2	3/4	P	300	1	PVBX2407	1STQ007927A0000	1/1
XT2	3/4	P - MO	300	1	PVBX2409	1STQ007931A0000	1/1
XT2	3/4	P - RHD	300	1	PVBX2427	1STQ007933A0000	1/1
XT2	3/4	W	300	1	PVBX2410	1STQ007935A0000	1/1
XT2	3/4	W - MO	300	1	PVBX2412	1STQ007937A0000	1/1
XT2	3/4	W - RHD	300	1	PVBX2400	1STQ007939A0000	1/1
XT2	4	F - RC	350	1	PVBX2423	1STQ007941A0000	1/1
XT2	4	W - RC	350	1	PVBX2417	1STQ007943A0000	1/1
XT3	3/4	F	300	1	PVBX3401	1STQ007945A0000	1/1
XT3	3/4	F - MO	300	1	PVBX3404	1STQ008467A0000	1/1
XT3	3/4	F - RHD	300	1	PVBX3405	1STQ007947A0000	1/1
XT3	3/4	P	300	1	PVBX3407	1STQ007949A0000	1/1
XT3	3/4	P - MO	300	1	PVBX3409	1STQ007952A0000	1/1
XT3	3/4	P - RHD	300	1	PVBX3427	1STQ007954A0000	1/1
XT3	4	F - RC	400	1	PVBX3423	1STQ007956A0000	1/1
XT4	3/4	F	300	1	PVBX4401	1STQ007960A0000	1/1
XT4	3/4	F - MO	300	1	PVBX4404	1STQ008468A0000	1/1
XT4	3/4	F - RHD	300	1	PVBX4405	1STQ007964A0000	1/1
XT4	3/4	P	350	1	PVBX4407	1STQ007966A0000	1/1
XT4	3/4	P - MO	350	1	PVBX4409	1STQ007970A0000	1/1
XT4	3/4	P - RHD	350	1	PVBX4427	1STQ007972A0000	1/1
XT4	3/4	W	350	1	PVBX4410	1STQ007974A0000	1/1
XT4	3/4	W - MO	350	1	PVBX4412	1STQ007976A0000	1/1
XT4	3/4	W - RHD	350	1	PVBX4400	1STQ007978A0000	1/1
XT4	4	F - RC	400	1	PVBX4423	1STQ007958A0000	1/1
XT4	4	W - RC	400	1	PVBX4417	1STQ007980A0000	1/1
T4	3/4	F	350	1	PVBT4406	1STQ007982A0000	1/1
T4	3/4	F - MO	350	1	PVBT4404	1STQ007984A0000	1/1
T4	3/4	F - RHD	350	1	PVBT4406	1STQ007982A0000	1/1
T4	4	F - RC	450	1	PVBT4423	1STQ007986A0000	1/1

CONTINUES

Key:

F	fixed
F - I	fixed interlocked
F - I-MO	fixed interlocked motor-operated
F - MO	fixed motor-operated
F - RC	fixed with residual current
F - RHD	fixed with Direct Rotary Handle
F & F - I	fixed and fixed interlocked
P	plug-in
P - I	plug-in interlocked
P - I-MO	plug-in interlocked motor-operated
P - MO	plug-in motor-operated
P - RC	plug-in with residual current
P - RHD	plug-in with Direct Rotary Handle
W	withdrawable
W - I	withdrawable interlocked
W - I-MO	withdrawable interlocked motor-operated
W - MO	withdrawable motor-operated
W - RC	withdrawable with residual current
W - RHD	withdrawable with Direct Rotary Handle
W & W - I	withdrawable and withdrawable interlocked

Compatible residual current devices:

Tmax XT
RC Inst. XT1-XT3, RC Sel. XT1-XT3 and RC Sel.. XT2-XT4 Type A. For XT1-XT3 fixed with residual current device high terminal covers are not available.

Tmax T
RC222 for T4 and T5.

To assemble these kits, order the dedicated intermediate depth uprights PUKI1800 for H= 1800mm or PUKI2000 for H=2000mm. Intermediate uprights are not required for assembling fixed Tmax XT1, XT2, XT3, XT4, T4, T5, T6 and XT1, XT3 with Direct Rotary Handle only in non-segregated structures. Order the dedicated fixed frame PFPF... or swing frame PFPS... for assembling internal panels. For D=300mm structures, consult the details on page 3/21. For fixed and withdrawable 3P breakers Tmax XT, non accessorized and mounted on 3/4P kit, it is necessary to order the dedicated cover flanges: AD3305 flange for XT1 3P mounted on plate, AD3306 flange for XT2 3P mounted on plate, AD3307 flange for XT3 3P mounted on plate, AD3308 flange for XT4 3P mounted on plate. With interlocked or interlocked motor-operated kits, it is necessary to order the quantity of flanges equal to the quantity of breakers.

> Quick selection guides page 3/4 > Technical details page 7/1 > Overall dimensions page 8/1

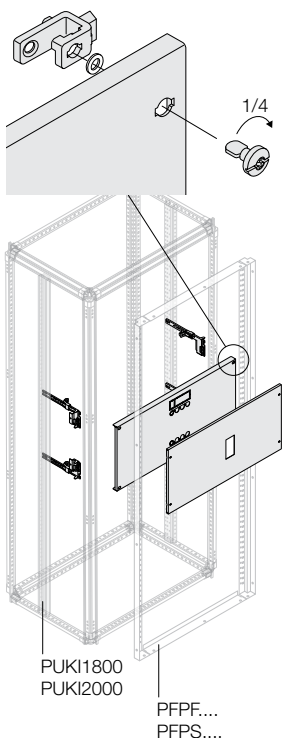

Kits for installation of Tmax circuit-breakers

Vertical installation (front or rear connections)

The kit includes the dedicated fixing brackets, the mounting plate and panels with 1/4 turn screws, hinged on the right or the left with the dedicated PHFP0020 kit.

Tmax	No. poles	Version	Dimensions H (mm)	No. CB per compartment	Order code	ABB code	Package/No. pcs
12 DIN modules - W=400mm							
T5	3/4	F 400A/630A	350	1	PVBT5406	1STQ007988A0000	1/1
T5	3/4	F - MO 400A/630A	350	1	PVBT5404	1STQ007990A0000	1/1
T5	3/4	F - RHD 400A/630A	350	1	PVBT5406	1STQ007988A0000	1/1
T5	3/4	P 400A	350	1	PVBT5426	1STQ007992A0000	1/1
T5	3/4	P - RHD 400A	350	1	PVBT5426	1STQ007992A0000	1/1
T5	3/4	W 400A	350	1	PVBT5414	1STQ007993A0000	1/1
T5	3/4	W - MO 400A	350	1	PVBT5412	1STQ007995A0000	1/1
T5	3/4	W - RHD 400A	350	1	PVBT5414	1STQ007993A0000	1/1
T5	4	F - RC 400A	450	1	PVBT5423	1STQ007998A0000	1/1
T5	4	P - RC 400A	450	1	PVBT5428	1STQ008001A0000	1/1
T5	3	W 630A	450	1	PVBT5319	1STQ001470B0000	1/1
T6	3	W	450	1	PVBT6314	1STQ008024A0000	1/1
T6	3	W - MO	450	1	PVBT6312	1STQ008025A0000	1/1
T6	3	W - RHD	450	1	PVBT6314	1STQ008024A0000	1/1
T6	3/4	F	400	1	PVBT6401	1STQ008015A0000	1/1
T6	3/4	F - MO	400	1	PVBT6404	1STQ008018A0000	1/1
T6	3/4	F - RHD	400	1	PVBT6405	1STQ008021A0000	1/1
24 DIN modules - W=600mm							
XT1	3/4	F	300	1	PVCX1401	1STQ007909A0000	1/1
XT1	3/4	F - MO	300	1	PVCX1404	1STQ008469A0000	1/1
XT1	3/4	F - RHD	300	1	PVCX1405	1STQ007913A0000	1/1
XT1	3/4	P	300	1	PVCX1407	1STQ007915A0000	1/1
XT1	3/4	P	300	3	PVCX1707	1STQ009146A0000	1/1
XT1	3/4	P - MO	300	1	PVCX1409	1STQ007917A0000	1/1
XT1	3/4	P - RHD	300	1	PVCX1427	1STQ007919A0000	1/1
XT1	4	F - RC	300	1	PVCX1423	1STQ007911A0000	1/1
XT2	3/4	F	300	3	PVCX2701	1STQ007923A0000	1/1
XT2	3/4	F	300	1	PVCX2401	1STQ007922A0000	1/1
XT2	3/4	F - MO	300	1	PVCX2404	1STQ008470A0000	1/1
XT2	3/4	F - RHD	300	1	PVCX2405	1STQ007926A0000	1/1
XT2	3/4	P	300	3	PVCX2707	1STQ007929A0000	1/1
XT2	3/4	P	300	1	PVCX2407	1STQ007928A0000	1/1
XT2	3/4	P - MO	300	1	PVCX2409	1STQ007932A0000	1/1
XT2	3/4	P - RHD	300	1	PVCX2427	1STQ007934A0000	1/1
XT2	3/4	W	300	1	PVCX2410	1STQ007936A0000	1/1
XT2	3/4	W - MO	300	1	PVCX2412	1STQ007938A0000	1/1
XT2	3/4	W - RHD	300	1	PVCX2400	1STQ007940A0000	1/1
XT2	4	F - RC	350	1	PVCX2423	1STQ007942A0000	1/1
XT2	4	W - RC	350	1	PVCX2417	1STQ007944A0000	1/1
XT3	3	P	300	3	PVCX3707	1STQ009149A0000	1/1
XT3	3/4	F	300	1	PVCX3401	1STQ007946A0000	1/1
XT3	3/4	F - MO	300	1	PVCX3404	1STQ008471A0000	1/1
XT3	3/4	F - RHD	300	1	PVCX3405	1STQ007948A0000	1/1
XT3	3/4	P	300	1	PVCX3407	1STQ007950A0000	1/1
XT3	3/4	P	300	2	PVCX3607	1STQ009148A0000	1/1

■ Front terminals, only Form 1

CONTINUES

Key:

- F fixed
- F - I fixed interlocked
- F - I-MO fixed interlocked motor-operated
- F - MO fixed motor-operated
- F - RC fixed with residual current
- F - RHD fixed with Direct Rotary Handle
- F & F - I fixed and fixed interlocked
- P plug-in
- P - I plug-in interlocked
- P - I-MO plug-in interlocked motor-operated
- P - MO plug-in motor-operated
- P - RC plug-in with residual current
- P - RHD plug-in with Direct Rotary Handle
- W withdrawable
- W - I withdrawable interlocked
- W - I-MO withdrawable interlocked motor-operated
- W - MO withdrawable motor-operated
- W - RC withdrawable with residual current
- W - RHD withdrawable with Direct Rotary Handle
- W & W - I withdrawable and withdrawable interlocked

Compatible residual current devices:

Tmax XT

RC Inst. XT1-XT3, RC Sel. XT1-XT3 and RC Sel.. XT2-XT4 Type A. For XT1-XT3 fixed with residual current device high terminal covers are not available.

Tmax T

RC222 for T4 and T5.

To assemble these kits, order the dedicated intermediate depth uprights PUK1800 for H= 1800mm or PUK1200 for H=2000mm. Intermediate uprights are not required for assembling fixed Tmax XT1, XT2, XT3, XT4, T4, T5, T6 and XT1, XT3 with Direct Rotary Handle only in non-segregated structures. Order the dedicated fixed frame PFPF... or swing frame PFPS... for assembling internal panels. For D=300mm structures, consult the details on page 3/21. For fixed and withdrawable 3P breakers Tmax XT, non accessorized and mounted on 3/4P kit, it is necessary to order the dedicated cover flanges: AD3305 flange for XT1 3P mounted on plate, AD3306 flange for XT2 3P mounted on plate, AD3307 flange for XT3 3P mounted on plate, AD3308 flange for XT4 3P mounted on plate. With interlocked or interlocked motor-operated kits, it is necessary to order the quantity of flanges equal to the quantity of breakers.

System pro E power

Order codes - Internal kits

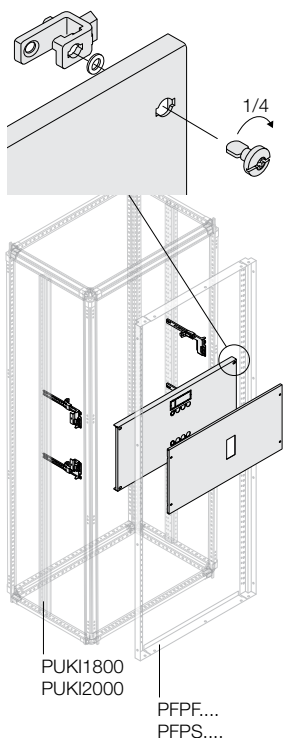

Kits for installation of Tmax circuit-breakers

Vertical installation (front or rear connections)

The kit includes the dedicated fixing brackets, the mounting plate and panels with 1/4 turn screws, hinged on the right or the left with the dedicated PHFP0020 kit.

Tmax	No. poles	Version	Dimensions H (mm)	No. CB per compartment	Order code	ABB code	Package/No. pcs
24 DIN modules - W=600mm							
XT3	3/4	P - MO	300	1	PVCX3409	1STQ007953A0000	1/1
XT3	3/4	P - RHD	300	1	PVCX3427	1STQ007955A0000	1/1
XT3	4	F - RC	400	1	PVCX3423	1STQ007957A0000	1/1
XT4	3/4	F	300	1	PVCX4401	1STQ007961A0000	1/1
XT4	3/4	F	300	2	PVCX4601	1STQ009142A0000	1/1
XT4	3	F	300	3	PVCX4701	1STQ007962A0000	1/1
XT4	3/4	F - MO	300	1	PVCX4404	1STQ008472A0000	1/1
XT4	3/4	F - RHD	300	1	PVCX4405	1STQ007965A0000	1/1
XT4	3	P	350	3	PVCX4707	1STQ007968A0000	1/1
XT4	3/4	P	350	1	PVCX4407	1STQ007967A0000	1/1
XT4	3/4	P	350	2	PVCX4607	1STQ009144A0000	1/1
XT4	3/4	P - MO	350	1	PVCX4409	1STQ007971A0000	1/1
XT4	3/4	P - RHD	350	1	PVCX4427	1STQ007973A0000	1/1
XT4	3/4	W	350	1	PVCX4410	1STQ007975A0000	1/1
XT4	3/4	W - MO	350	1	PVCX4412	1STQ007977A0000	1/1
XT4	3/4	W - RHD	350	1	PVCX4400	1STQ007979A0000	1/1
XT4	4	F - RC	400	1	PVCX4423	1STQ007983A0000	1/1
XT4	4	W - RC	400	1	PVCX4417	1STQ007981A0000	1/1
T4	3/4	F	350	1	PVCT4406	1STQ007983A0000	1/1
T4	3/4	F - MO	350	1	PVCT4404	1STQ007985A0000	1/1
T4	3/4	F - RHD	350	1	PVCT4406	1STQ007983A0000	1/1
T4	4	F - RC	450	1	PVCT4423	1STQ007987A0000	1/1
T5	3	P	200	1	PHCT5307	1STQ001467B0000	1/1
T5	3	W	300	1	PHCT5310	1STQ001469B0000	1/1
T5	3/4	F 400A/630A	350	1	PVCT5406	1STQ007989A0000	1/1
T5	3/4	F - MO 400A/630A	350	1	PVCT5404	1STQ007991A0000	1/1
T5	3/4	F - RHD 400A/630A	350	1	PVCT5406	1STQ007989A0000	1/1
T5	3/4	P 400A	350	1	PVCT5426	1STQ008004A0000	1/1
T5	3/4	P - RC 400A	350	1	PVCT5426	1STQ008004A0000	1/1
T5	3/4	W 400A	350	1	PVCT5414	1STQ007994A0000	1/1
T5	3/4	W - MO 400A	350	1	PVCT5412	1STQ007996A0000	1/1
T5	3/4	W - RHD 400A	350	1	PVCT5414	1STQ007994A0000	1/1
T5	4	F - RC 400A	450	1	PVCT5423	1STQ007999A0000	1/1
T5	4	P - RC 400A	450	1	PVCT5428	1STQ008002A0000	1/1
T5	3	P 630A	450	1	PVCT5307	1STQ001468B0000	1/1
T5	3	F 630A	450	3	PVCT5710	1STQ001438B0000	1/1
T5	3	W 630A	450	2	PVCT5601	1STQ001440B0000	1/1
T6	3/4	F	400	1	PVCT6401	1STQ008016A0000	1/1
T6	3/4	F - MO	400	1	PVCT6404	1STQ008019A0000	1/1
T6	3/4	F - RHD	400	1	PVCT6405	1STQ008022A0000	1/1
T6	3/4	W	450	1	PVCT6414	1STQ008026A0000	1/1
T6	3/4	W - MO	450	1	PVCT6412	1STQ008028A0000	1/1
T6	3/4	W - RHD	450	1	PVCT6414	1STQ008026A0000	1/1
T7	3/4	F	450	1	PVCT7419	1STQ008034A0000	1/1
T7	3/4	F - I	450	1	PVCT7419	1STQ008034A0000	1/1
T7	3/4	F - I-MO	450	1	PVCT7419	1STQ008034A0000	1/1
T7	3/4	F - MO	450	1	PVCT7419	1STQ008034A0000	1/1
T7	3/4	W	500	1	PVCT7413 *	1STQ008035A0000	1/1
T7	3/4	W - I	500	1	PVCT7413 *	1STQ008035A0000	1/1
T7	3/4	W - I-MO	500	1	PVCT7413 *	1STQ008035A0000	1/1
T7	3/4	W - MO	500	1	PVCT7413 *	1STQ008035A0000	1/1

Key:

F	fixed
F - I	fixed interlocked
F - I-MO	fixed interlocked motor-operated
F - MO	fixed motor-operated
F - RC	fixed with residual current
F - RHD	fixed with Direct Rotary Handle
F & F - I	fixed and direct interlocked
P	plug-in
P - I	plug-in interlocked
P - I-MO	plug-in interlocked motor-operated
P - MO	plug-in motor-operated
P - RC	plug-in with residual current
P - RHD	plug-in with Direct Rotary Handle
W	withdrawable
W - I	withdrawable interlocked
W - I-MO	withdrawable interlocked motor-operated
W - MO	withdrawable motor-operated
W - RC	withdrawable with residual current
W - RHD	withdrawable with Direct Rotary Handle
W & W - I	withdrawable and withdrawable interlocked

Compatible residual current devices:

Tmax XT

RC Inst. XT1-XT3, RC Sel. XT1-XT3 and RC Sel. XT2-XT4 Type A. For XT1-XT3 fixed with residual current device high terminal covers are not available.

Tmax T

RC222 for T4 and T5.

■ Front terminals, only Form 1
* Only rear terminals

CONTINUES

To assemble these kits, order the dedicated intermediate depth uprights PUK11800 for H= 1800mm or PUK12000 for H=2000mm. Intermediate uprights are not required for assembling fixed Tmax XT1, XT2, XT3, XT4, T4, T5, T6 and XT1, XT3 with Direct Rotary Handle only in non-segregated structures. Order the dedicated fixed frame PFPF... or swing frame PFPS... for assembling internal panels. For D=300mm structures, consult the details on page 3/21. For fixed and withdrawable 3P breakers Tmax XT, non accessorized and mounted on 3/4P kit, it is necessary to order the dedicated cover flanges: AD3305 flange for XT1 3P mounted on plate, AD3306 flange for XT2 3P mounted on plate, AD3307 flange for XT3 3P mounted on plate, AD3308 flange for XT4 3P mounted on plate. With interlocked or interlocked motor-operated kits, it is necessary to order the quantity of flanges equal to the quantity of breakers.

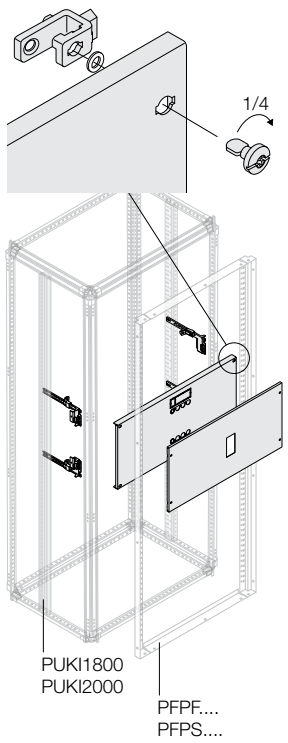

Kits for installation of Tmax circuit-breakers

Vertical installation (front or rear connections)

The kit includes the dedicated fixing brackets, the mounting plate and panels with 1/4 turn screws, hinged on the right or the left with the dedicated PHFP0020 kit.

Tmax	No. poles	Version	Dimensions H (mm)	No. CB per compartment	Order code	ABB code	Package/No. pcs
36 DIN modules - W=800mm							
XT1	3/4	P	300	4	PVDX1807	1STQ009147A0000	1/1
XT2	3/4	F	300	4	PVDX2801	1STQ007924A0000	1/1
XT2	3/4	P	300	4	PVDX2807	1STQ007930A0000	1/1
XT3	3	P	300	4	PVDX3807	1STQ009151A0000	1/1
XT3	3/4	P	300	3	PVDX3707	1STQ009150A0000	1/1
XT4	3/4	F	300	3	PVDX4701	1STQ009143A0000	1/1
XT4	3	F	300	4	PVDX4801	1STQ007963A0000	1/1
XT4	3	P	300	4	PVDX4807	1STQ007969A0000	1/1
XT4	3/4P	P	350	3	PVDX4707	1STQ009145A0000	1/1
T5	3/4	F 400A/630A	350	1	PVDT5406	1STQ008006A0000	1/1
T5	3/4	F - MO 400A/630A	350	1	PVDT5404	1STQ008007A0000	1/1
T5	3/4	F - RHD 400A/630A	350	1	PVDT5406	1STQ008006A0000	1/1
T5	3/4	P 400A	350	1	PVDT5426	1STQ008005A0000	1/1
T5	3/4	P - RHD 400A	350	1	PVDT5426	1STQ008005A0000	1/1
T5	3/4	W	350	2	PVDT5610	1STQ008480A0000	1/1
T5	3/4	W 400A	350	1	PVDT5414	1STQ008008A0000	1/1
T5	3/4	W - MO	350	2	PVDT5612	1STQ008481A0000	1/1
T5	3/4	W - MO 400A	350	1	PVDT5412	1STQ007997A0000	1/1
T5	3/4	W - RHD 400A	350	1	PVDT5414	1STQ008008A0000	1/1
T5	4	F - RC 400A	450	1	PVDT5423	1STQ008000A0000	1/1
T5	4	P - RC 400A	450	1	PVDT5428	1STQ008003A0000	1/1
T5	3	F 630A	450	4	PVDT5810	1STQ001439B0000	1/1
T5	3	W 630A	450	3	PVDT5701	1STQ001441B0000	1/1
T6	3/4	F	400	1	PVDT6401	1STQ008017A0000	1/1
T6	3/4	F - MO	400	1	PVDT6404	1STQ008020A0000	1/1
T6	3/4	F - RHD	400	1	PVDT6405	1STQ008023A0000	1/1
T6	3/4	W	450	1	PVDT6414	1STQ008027A0000	1/1
T6	3/4	W - MO	450	1	PVDT6412	1STQ008029A0000	1/1
T6	3/4	W - RHD	450	1	PVDT6414	1STQ008027A0000	1/1
T7	3/4	F	450	1	PVDT7419	1STQ008036A0000	1/1
T7	3/4	F - I	450	1	PVDT7419	1STQ008036A0000	1/1
T7	3/4	F - I - MO	450	1	PVDT7419	1STQ008036A0000	1/1
T7	3/4	F - MO	450	1	PVDT7419	1STQ008036A0000	1/1
T7	3/4	W	500	1	PVDT7413 *	1STQ008037A0000	1/1
T7	3/4	W - I	500	1	PVDT7413 *	1STQ008037A0000	1/1
T7	3/4	W - I - MO	500	1	PVDT7413 *	1STQ008037A0000	1/1
T7	3/4	W - MO	500	1	PVDT7413 *	1STQ008037A0000	1/1
48 DIN modules - W=1000mm							
T5	3	W	350	4	PVFT5810	1STQ008013A0000	1/1
T5	3	W - MO	350	4	PVFT5812	1STQ008014A0000	1/1
T5	3/4	W	350	3	PVFT5710	1STQ008482A0000	1/1
T5	3/4	W - MO	350	3	PVFT5712	1STQ008483A0000	1/1
T6	3/4	W	450	2	PVFT6610	1STQ008478A0000	1/1
T6	3/4	W - MO	450	2	PVFT6612	1STQ008479A0000	1/1
T7	3/4	W	500	2	PVFT7633 *	1STQ008477A0000	1/1
T7	3/4	W - MO	500	2	PVFT7633 *	1STQ008477A0000	1/1

Key:

- F fixed
- F - I fixed interlocked
- F - I-MO fixed interlocked motor-operated
- F - MO fixed motor-operated
- F - RC fixed with residual current
- F - RHD fixed with Direct Rotary Handle
- F & F - I fixed and fixed interlocked
- P plug-in
- P - I plug-in interlocked
- P - I-MO plug-in interlocked motor-operated
- P - MO plug-in motor-operated
- P - RC plug-in with residual current
- P - RHD plug-in with Direct Rotary Handle
- W withdrawable
- W - I withdrawable interlocked
- W - I-MO withdrawable interlocked motor-operated
- W - MO withdrawable motor-operated
- W - RC withdrawable with residual current
- W - RHD withdrawable with Direct Rotary Handle
- W & W - I withdrawable and withdrawable interlocked

Compatible residual current devices:

Tmax XT

RC Inst. XT1-XT3, RC Sel. XT1-XT3 and RC Sel.. XT2-XT4 Type A. For XT1-XT3 fixed with residual current device high terminal covers are not available.

Tmax T

RC222 for T4 and T5.

■ Front terminals, only Form 1

* Only rear terminals

To assemble these kits, order the dedicated intermediate depth uprights PUK11800 for H= 1800mm or PUK12000 for H=2000mm. Intermediate uprights are not required for assembling fixed Tmax XT1, XT2, XT3, XT4, T4, T5, T6 and XT1, XT3 with Direct Rotary Handle only in non-segregated structures. Order the dedicated fixed frame PFPF... or swing frame PFPS.... for assembling internal panels. For D=300mm structures, consult the details on page 3/21. For fixed and withdrawable 3P breakers Tmax XT, non accessorized and mounted on 3/4P kit, it is necessary to order the dedicated cover flanges: AD3305 flange for XT1 3P mounted on plate, AD3306 flange for XT2 3P mounted on plate, AD3307 flange for XT3 3P mounted on plate, AD3308 flange for XT4 3P mounted on plate. With interlocked or interlocked motor-operated kits, it is necessary to order the quantity of flanges equal to the quantity of breakers.

System pro E power

Order codes - Internal kits

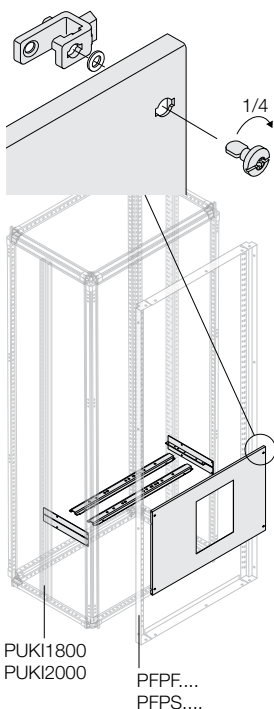

Kit per installazione interruttori Emax 2

Vertical installation (front or rear connections)

The kit includes the dedicated fixing brackets, the mounting plate and panels with 1/4 turn screws, hinged on the right or the left with the dedicated PHFP0020 kit.

Emax	No. poles	Version	Dimensions H (mm)	No. CB per compartment	Order code	ABB code	Package/No. pcs
Front or rear connections							
12 DIN modules - W=400mm							
E1.2	3/4	F	450	1	PVBE1241	1STQ008179A0000	1/1
E1.2	3/4	F - I	450	1	PVBE1241	1STQ008179A0000	1/1
24 DIN modules - W=600mm							
E1.2	3/4	F	450	1	PVCE1241	1STQ008184A0000	1/1
E1.2	3/4	F - I	450	1	PVCE1241	1STQ008184A0000	1/1
E1.2	3/4	W	500	1	PVCE1240	1STQ008185A0000	1/1
E1.2	3/4	W - I	500	1	PVCE1240	1STQ008185A0000	1/1
36 DIN modules - W=800mm							
E1.2	3/4	F	450	1	PVDE1241	1STQ008188A0000	1/1
E1.2	3/4	F - I	450	1	PVDE1241	1STQ008188A0000	1/1
E1.2	3/4	F	450	2	PVDE1262	1STQ008485A0000	1/1
E1.2	3/4	W	500	1	PVDE1240	1STQ008189A0000	1/1
E1.2	3/4	W - I	500	1	PVDE1240	1STQ008189A0000	1/1
48 DIN modules - W=1000mm							
E1.2	3/4	W	500	2	PVFE1263	1STQ008486A0000	1/1
Only rear connections							
24 DIN modules - W=600mm							
E2.2	3/4	F	600	1	PVCE2441	1STQ008186A0000	1/1
E2.2	3/4	F - I	600	1	PVCE2441	1STQ008186A0000	1/1
E2.2	3/4	W	600	1	PVCE2450	1STQ008187A0000	1/1
E2.2	3/4	W - I	600	1	PVCE2450	1STQ008187A0000	1/1
E4.2	3	W	600	1	PVCE4350	1STQ009991A0000	1/1
E4.2	3	W - I	600	1	PVCE4350	1STQ009991A0000	1/1
E4.2	3/4	F	600	1	PVCE2442	1STQ008484A0000	1/1
36 DIN modules - W=800mm							
E2.2	3/4	F	600	1	PVDE2441	1STQ008190A0000	1/1
E2.2	3/4	F - I	600	1	PVDE2441	1STQ008190A0000	1/1
E2.2	3/4	W	600	1	PVDE2440	1STQ008191A0000	1/1
E2.2	3/4	W - I	600	1	PVDE2440	1STQ008191A0000	1/1
E4.2	3/4	F	600	1	PVDE2441	1STQ008190A0000	1/1
E4.2	3/4	F - I	600	1	PVDE2441	1STQ008190A0000	1/1
E4.2	3/4	W	600	1	PVDE2440	1STQ008191A0000	1/1
E4.2	3/4	W - I	600	1	PVDE2440	1STQ008191A0000	1/1
48 DIN modules - W=1000mm							
E6.2	3/4 HS	F	700	1	PVFE6231	1STQ008192A0000	1/1
E6.2	3	F - I	700	1	PVFE6231	1STQ008192A0000	1/1
E6.2	3	W	700	1	PVFE6230	1STQ008193A0000	1/1
E6.2	3	W - I	700	1	PVFE6230	1STQ008193A0000	1/1
62 DIN modules - W=1250mm							
E6.2	4 HS/FS	F	700	1	PVGE6231	1STQ008194A0000	1/1
E6.2	4 HS/FS	F - I	700	1	PVGE6231	1STQ008194A0000	1/1
E6.2	4 HS/FS	W	700	1	PVGE6230	1STQ008195A0000	1/1
E6.2	4 HS/FS	W - I	700	1	PVGE6230	1STQ008195A0000	1/1

Key:

F	fixed
F - I	fixed interlocked
W	withdrawable
W - I	withdrawable interlocked
HS	50% neutral
FS	100% neutral

To assemble these kits, order the dedicated intermediate depth uprights PUKI1800 for H= 1800mm or PUKI2000 for H=2000mm. Order the dedicated fixed frame PFPF... or swing frame PFPS... for assembling internal panels.

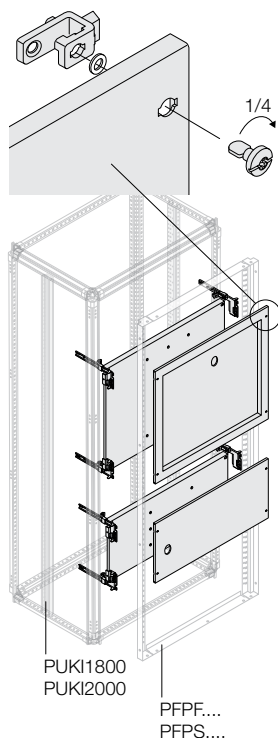

Kits for OT

Kit for OT switch-disconnectors available up to 1600A both in horizontal and vertical version. The kit includes the dedicated fixing brackets, the mounting plate and panels with 1/4 turn screws, hinged on the right or the left with the dedicated PHFP0020 kit. For structure with intermediate upright.

Description	Dimensioni (mm)		Lenght		Lever position	Codice ordinazione	ABB code	Package/ No. pcs
	H	L	Max lever (mm)	Min. shaft (mm)				
Vertical installation 3/4 poles								
Kits for OT 160, 200, 250	350	600	80 (Ø6)	130 (Ø6)	E03-E04	PKOV1660	1STQ007437A0000	1/1
Kits for OT 160, 200, 250	350	800	80 (Ø6)	130 (Ø6)	E03-E04	PKOV1680	1STQ007440A0000	1/1
Kits for OT 315, 400	450	600	175 (Ø12)	95 (Ø12)	E03-E04	PKOV3160	1STQ008399A0000	1/1
Kits for OT 315, 400	450	800	175 (Ø12)	95 (Ø12)	E03-E04	PKOV3180	1STQ008400A0000	1/1
Kits for OT 630, 800	500	600	175 (Ø12)	70 (Ø12)	E03-E04	PKOV6360	1STQ007438A0000	1/1
Kits for OT 630, 800	500	800	175 (Ø12)	70 (Ø12)	E03-E04	PKOV6380	1STQ007441A0000	1/1
Kits for OT 1000, 1250, 1600	600	600	175 (Ø12)	170 (Ø12)	E12-E22	PKOV1060	1STQ007439A0000	1/1
Kits for OT 1000, 1250, 1600	600	800	175 (Ø12)	170 (Ø12)	E12-E22	PKOV1080	1STQ007442A0000	1/1
Horizontal installation 3/4 poles								
Kits for OT 160, 200, 250	250	600	80 (Ø6)	130 (Ø6)	E03-E04	PKOH1660	1STQ007443A0000	1/1
Kits for OT 160, 200, 250	250	800	80 (Ø6)	130 (Ø6)	E03-E04	PKOH1680	1STQ007446A0000	1/1
Kits for OT 315, 400	300	600	175 (Ø12)	95 (Ø12)	E03-E04	PKOH3160	1STQ008401A0000	1/1
Kits for OT 315, 400	300	800	175 (Ø12)	95 (Ø12)	E03-E04	PKOH3180	1STQ008402A0000	1/1
Kits for OT 630, 800	500	600	175 (Ø12)	70 (Ø12)	E03-E04	PKOH6360	1STQ007444A0000	1/1
Kits for OT 630, 800	500	800	175 (Ø12)	70 (Ø12)	E03-E04	PKOH6380	1STQ007447A0000	1/1
Kits for OT 1000, 1250, 1600	600	600	175 (Ø12)	170 (Ø12)	E12-E22 ⁽¹⁾	PKOH1060	1STQ007445A0000	1/1
Kits for OT 1000, 1250, 1600	600	800	175 (Ø12)	170 (Ø12)	E12-E22	PKOH1080	1STQ007448A0000	1/1

⁽¹⁾ Only low terminal covers.

Order the dedicated fixed frame PFPF... or swing frame PFPF... for assembling internal panels.

System pro E power

Order codes - Internal kits

3

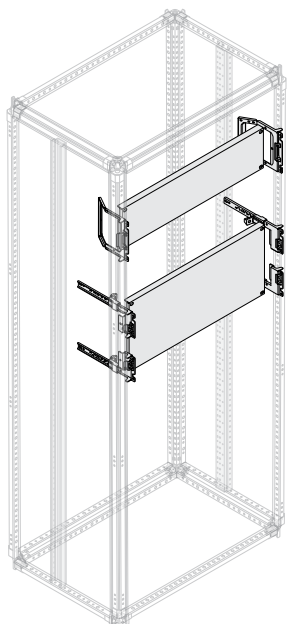

Blind mounting plates

The kit includes the dedicated fixing brackets and the mounting plate.

Description	Dimensions (mm)		Order code	ABB code	Package/ No. pcs
	H	W			
Blind assembly plate	150	400	PPMB1540	1STQ007521A0000	1/1
Blind assembly plate	200	400	PPMB2040	1STQ007522A0000	1/1
Blind assembly plate	250	400	PPMB2540	1STQ007523A0000	1/1
Blind assembly plate	300	400	PPMB3040	1STQ007524A0000	1/1
Blind assembly plate	400	400	PPMB4040	1STQ007525A0000	1/1
Blind assembly plate	500	400	PPMB5004	1STQ007526A0000	1/1
Blind assembly plate	600	400	PPMB6040	1STQ007527A0000	1/1
Blind assembly plate	150	600	PPMB1560	1STQ007533A0000	1/1
Blind assembly plate	200	600	PPMB2060	1STQ007534A0000	1/1
Blind assembly plate	250	600	PPMB2560	1STQ007535A0000	1/1
Blind assembly plate	300	600	PPMB3060	1STQ007536A0000	1/1
Blind assembly plate	400	600	PPMB4060	1STQ007537A0000	1/1
Blind assembly plate	500	600	PPMB5006	1STQ007538A0000	1/1
Blind assembly plate	600	600	PPMB6060	1STQ007539A0000	1/1
Blind assembly plate	150	800	PPMB1580	1STQ007545A0000	1/1
Blind assembly plate	200	800	PPMB2080	1STQ007546A0000	1/1
Blind assembly plate	250	800	PPMB2580	1STQ007547A0000	1/1
Blind assembly plate	300	800	PPMB3080	1STQ007548A0000	1/1
Blind assembly plate	400	800	PPMB4080	1STQ007549A0000	1/1
Blind assembly plate	500	800	PPMB5008	1STQ007550A0000	1/1
Blind assembly plate	600	800	PPMB6080	1STQ007551A0000	1/1
Blind assembly plate	200	1000	PPMB2010	1STQ007556A0000	1/1
Blind assembly plate	300	1000	PPMB3010	1STQ007557A0000	1/1
Blind assembly plate	400	1000	PPMB4010	1STQ007558A0000	1/1
Blind assembly plate	500	1000	PPMB5001	1STQ007559A0000	1/1
Blind assembly plate	600	1000	PPMB6010	1STQ007560A0000	1/1
Blind assembly plate	200	1250	PPMB2012	1STQ007565A0000	1/1
Blind assembly plate	250	1250	PPMB2512	1STQ009156A0000	1/1
Blind assembly plate	300	1250	PPMB3012	1STQ007566A0000	1/1
Blind assembly plate	350	1250	PPMB3512	1STQ009157A0000	1/1

PPMB1540
PPMB1580

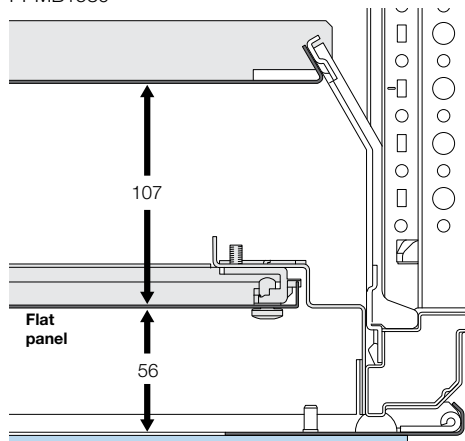

PPMB2040...PPMB6010

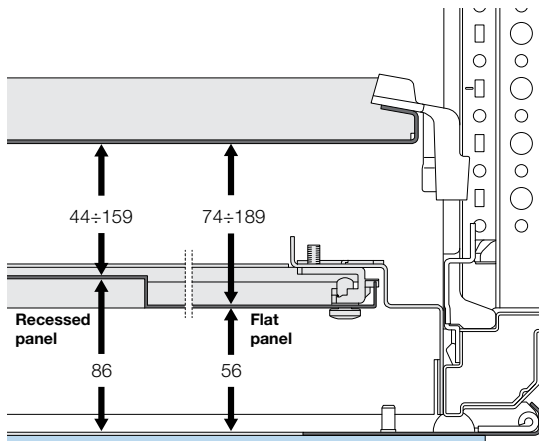

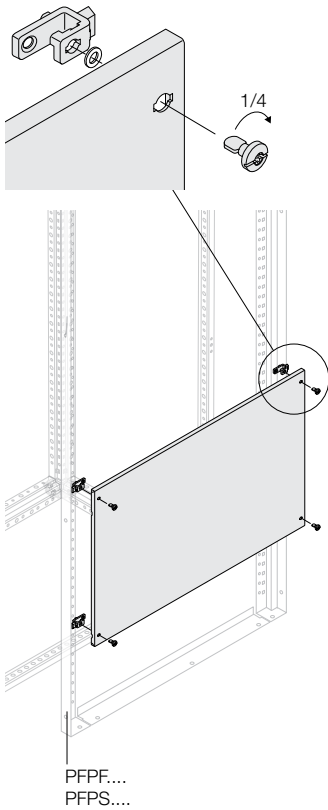

Flat blind panels

Panels with 1/4 turn screws, hinged on the right or left with the dedicated PHFP0020 kit.

Description	Dimensions (mm)		Order code	ABB code	Package/ No. pcs
	H	W			
Flat blind panel	50	400	PPFB5040	1STQ007465A0000	1/1
Flat blind panel	100	400	PPFB1040	1STQ007466A0000	1/1
Flat blind panel	150	400	PPFB1540	1STQ007467A0000	1/1
Flat blind panel	200	400	PPFB2040	1STQ007468A0000	1/1
Flat blind panel	250	400	PPFB2540	1STQ007469A0000	1/1
Flat blind panel	300	400	PPFB3040	1STQ007470A0000	1/1
Flat blind panel	400	400	PPFB4040	1STQ007471A0000	1/1
Flat blind panel	500	400	PPFB5004	1STQ007472A0000	1/1
Flat blind panel	600	400	PPFB6040	1STQ007473A0000	1/1
Flat blind panel	800	400	PPFB8040	1STQ007474A0000	1/1
Flat blind panel	1800	400	PPFB1840*	1STQ007475A0000	1/1
Flat blind panel	2000	400	PPFB2004*	1STQ007476A0000	1/1
Flat blind panel	50	600	PPFB5060	1STQ007477A0000	1/1
Flat blind panel	100	600	PPFB1060	1STQ007478A0000	1/1
Flat blind panel	150	600	PPFB1560	1STQ007479A0000	1/1
Flat blind panel	200	600	PPFB2060	1STQ007480A0000	1/1
Flat blind panel	250	600	PPFB2560	1STQ007481A0000	1/1
Flat blind panel	300	600	PPFB3060	1STQ007482A0000	1/1
Flat blind panel	400	600	PPFB4060	1STQ007483A0000	1/1
Flat blind panel	500	600	PPFB5006	1STQ007484A0000	1/1
Flat blind panel	600	600	PPFB6060	1STQ007485A0000	1/1
Flat blind panel	800	600	PPFB8060	1STQ007486A0000	1/1
Flat blind panel	1800	600	PPFB1860*	1STQ007487A0000	1/1
Flat blind panel	2000	600	PPFB2006*	1STQ007488A0000	1/1
Flat blind panel	50	800	PPFB5080	1STQ007489A0000	1/1
Flat blind panel	100	800	PPFB1080	1STQ007490A0000	1/1
Flat blind panel	150	800	PPFB1580	1STQ007491A0000	1/1
Flat blind panel	200	800	PPFB2080	1STQ007492A0000	1/1
Flat blind panel	250	800	PPFB2580	1STQ007493A0000	1/1
Flat blind panel	300	800	PPFB3080	1STQ007494A0000	1/1
Flat blind panel	400	800	PPFB4080	1STQ007495A0000	1/1
Flat blind panel	500	800	PPFB5008	1STQ007496A0000	1/1
Flat blind panel	600	800	PPFB6080	1STQ007497A0000	1/1
Flat blind panel	800	800	PPFB8080	1STQ007498A0000	1/1
Flat blind panel	1800	800	PPFB1880*	1STQ007499A0000	1/1
Flat blind panel	2000	800	PPFB2008*	1STQ007500A0000	1/1
Flat blind panel	100	1000	PPFB1010	1STQ007501A0000	1/1
Flat blind panel	200	1000	PPFB2010	1STQ007502A0000	1/1
Flat blind panel	300	1000	PPFB3010	1STQ007503A0000	1/1
Flat blind panel	400	1000	PPFB4010	1STQ007504A0000	1/1
Flat blind panel	500	1000	PPFB5001	1STQ007505A0000	1/1
Flat blind panel	600	1000	PPFB6010	1STQ007506A0000	1/1
Flat blind panel	800	1000	PPFB8010	1STQ007507A0000	1/1
Flat blind panel	200	1250	PPFB2012	1STQ007511A0000	1/1
Flat blind panel	250	1250	PPFB2512	1STQ009154A0000	1/1
Flat blind panel	300	1250	PPFB3012	1STQ007512A0000	1/1
Flat blind panel	350	1250	PPFB3512	1STQ009155A0000	1/1

Order the dedicated fixed frame PPFF... or swing frame PFPS... for assembling internal panels.

* Only for swing frame PFPS.... Not compatible with the hinges accessory PHFP0020.

System pro E power

Order codes - Internal kits

3

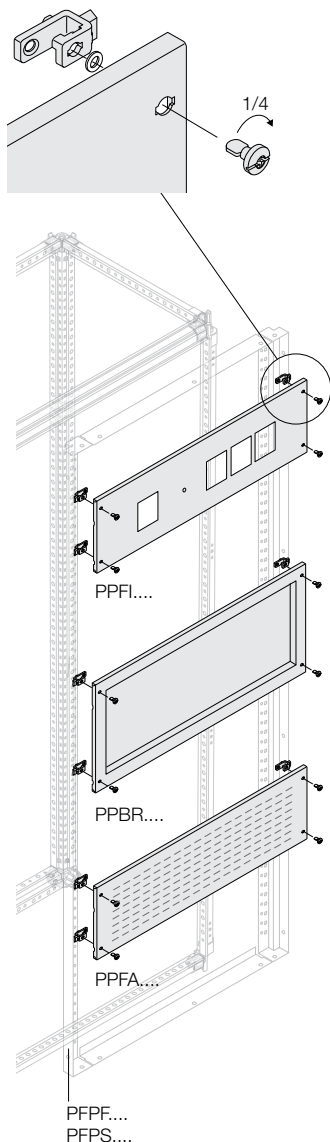

Panels for square measuring instruments

Panels with 1/4 turn screws, hinged on the right or left with the dedicated PHFP0020 kit.

Description	Dimensions (mm)		Order code	ABB code	Package/ No. pcs
	H	W			
Panel 2 instruments 72x72	200	600	PPFI2726	1STQ008092A0000	1/1
Panel 2 instruments 72x72	200	800	PPFI2728	1STQ008093A0000	1/1
Panel 2 instruments 96x96	200	600	PPFI2966	1STQ008094A0000	1/1
Panel 2 instruments 96x96	200	800	PPFI2968	1STQ008095A0000	1/1
Panel 4 instruments 72x72	200	600	PPFI4726	1STQ008096A0000	1/1
Panel 4 instruments 72x72	200	800	PPFI4728	1STQ008097A0000	1/1
Panel 4 instruments 96x96	200	800	PPFI4968	1STQ008098A0000	1/1

Recessed blind panels

Description	Dimensions (mm)		Order code	ABB code	Package/ No. pcs
	H	W			
Recessed blind panel	200	400	PPBR2040	1STQ007723A0000	1/1
Recessed blind panel	400	400	PPBR4040	1STQ007724A0000	1/1
Recessed blind panel	600	400	PPBR6040	1STQ007725A0000	1/1
Recessed blind panel	200	600	PPBR2060	1STQ007726A0000	1/1
Recessed blind panel	400	600	PPBR4060	1STQ007727A0000	1/1
Recessed blind panel	600	600	PPBR6060	1STQ007728A0000	1/1
Recessed blind panel	200	800	PPBR2080	1STQ007729A0000	1/1
Recessed blind panel	400	800	PPBR4080	1STQ007730A0000	1/1
Recessed blind panel	600	800	PPBR6080	1STQ007731A0000	1/1

Ventilated panels

Description	Dimensions (mm)		Order code	ABB code	Package/ No. pcs
	H	W			
Ventilated panel	100	400	PPFA1040	1STQ007732A0000	1/1
Ventilated panel	200	400	PPFA2040	1STQ007733A0000	1/1
Ventilated panel	100	600	PPFA1060	1STQ007734A0000	1/1
Ventilated panel	200	600	PPFA2060	1STQ007735A0000	1/1
Ventilated panel	100	800	PPFA1080	1STQ007736A0000	1/1
Ventilated panel	200	800	PPFA2080	1STQ007737A0000	1/1
Ventilated panel	100	1000	PPFA1010	1STQ007738A0000	1/1
Ventilated panel	200	1000	PPFA2010	1STQ007739A0000	1/1

Order the dedicated fixed frame PFPF... or swing frame PFPS.... for assembling internal panels.

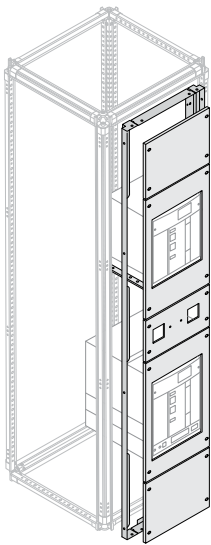

Space-saving” column W=400mm

The “space-saving” column is an extra opportunity in addition to the offer presented until now.

The “space-saving” column is composed of one reduced fixed frame (H=1800mm or H=2000mm) for W=400mm columns with two fixed positions for the kit exclusively dedicated to:

- E1.2 3/4 P W;
- E2.2 3P F;
- E2.2 3P W.

In order to complete this solution:
 blind panel H=100, 200, 300 and 600mm;
 modular or instrument panels H=200mm.

In this column type, it is not possible to mount kits for air-circuit breakers, moulded-case circuit breakers or modular breakers. The only possible configurations are the following ones.

Description	Dimensions (mm)		Order code	ABB code	Package/ No. pcs
	H	W			
Frame					
Reduced fixed frame	1800	400	PFRF1840	1STQ009283A0000	1/1
Reduced fixed frame	2000	400	PFRF2040	1STQ009284A0000	1/1
Kit for reduced frame					
E1.2 3/4 P W vertical	600	400	PRBE1243	1STQ009285A0000	1/1
E2.2 3 P F vertical	600	400	PRBE2232	1STQ009286A0000	1/1
E2.2 3 P W vertical	600	400	PRBE2233	1STQ009287A0000	1/1
Panel for reduced frame					
Blind panel	100	400	PBRP1040	1STQ009288A0000	1/1
Blind panel	200	400	PBRP2040	1STQ009289A0000	1/1
Blind panel	300	400	PBRP3040	1STQ009290A0000	1/1
Blind panel	600	400	PBRP6040	1STQ009291A0000	1/1
Modular panel	200	400	PMRP2040	1STQ009292A0000	1/1
Standard DIN Rail		400	PDRS0400	1STQ008041A0000	1/1
Panel 2 instruments 72x72	200	400	PIRP2040	1STQ009293A0000	1/1

Key:

- F fixed
- W withdrawable

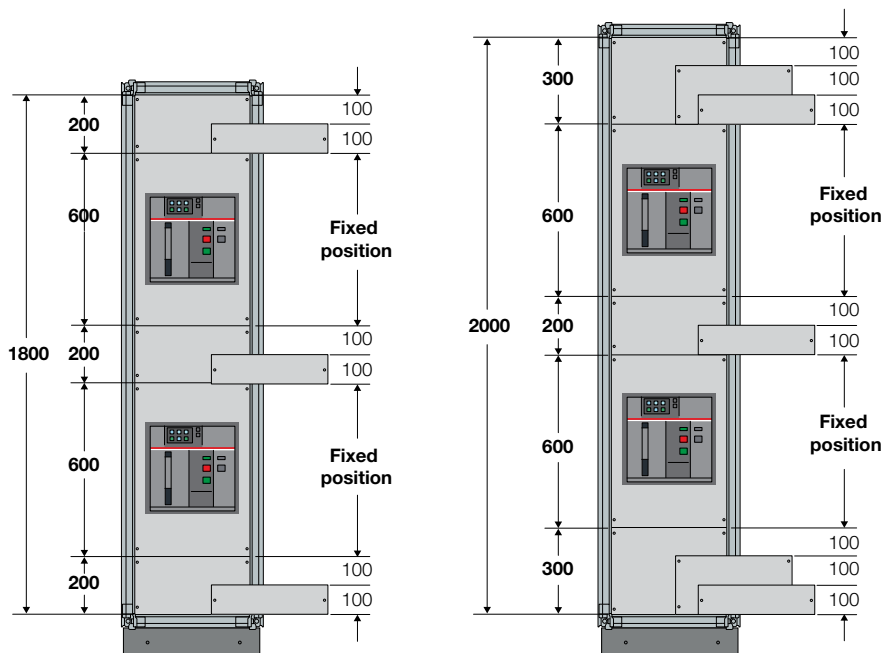

System pro E power

Order codes - Accessories and spare parts

3

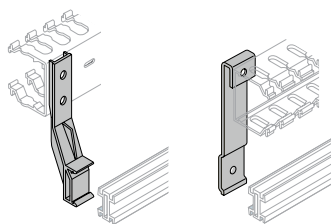

AD1009

AD1037

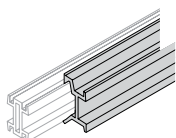

AP6000

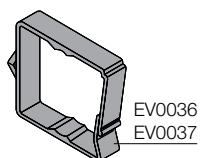

EV0036
EV0037

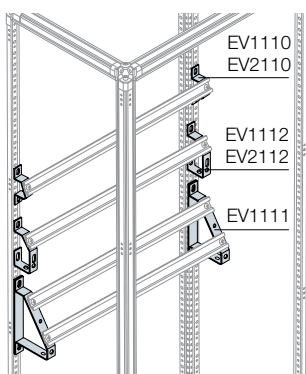

EV1110
EV2110

EV1112
EV2112

EV1111

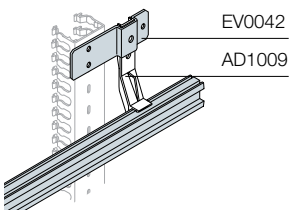

EV0042

AD1009

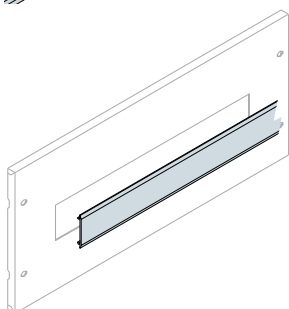

DIN rail accessories

With fixed frame for panels, maximum wiring ducts dimension is 60x60mm.

Description	Code	ABB code	Package/ No. pcs
Supports for horizontal wiring ducts			
No.4 plastic supports for horizontal wiring ducts	AD1009*	1STQ008200A0000	1/4
No.4 plastic supports for horizontal wiring ducts	AD1037*	1STQ008201A0000	1/4
No.4 metal supports reduced wiring ducts	PSRM1515**	1STQ009164A0000	1/4
Depth adapter			
Depth adapter for Tmax T1-T2-T3-XT1-XT3 W=600mm	AP6000	1STQ008202A0000	1/1

* To be used in case of not segregated DIN rail with panels $H \geq 200$ mm.

** To be used in case of DIN rail with panels $H = 300$ mm (2 DIN rail) or always in case of segregated DIN rail.

Universal cable holder brackets

Description	Code	ABB code	Package/ No. pcs
No.5 cable holder D=28,5mm	EV0036	1STQ006605A0000	1/5
No.5 cable holder D=55mm	EV0037	1STQ006627A0000	1/5

Angled supports for terminal boxes and earthing busbars

Description	Code	ABB code	Package/ No. pcs
No.50 angled supports 1 row of terminals	EV1110	1STQ001007A0000	1/50
No.10 angled supports 1 row of terminals	EV2110	1STQ003202A0000	1/10
No.10 angled supports double row of terminals	EV1111	1STQ001008A0000	1/10
No.50 angled supports 1 row of terminals + earth	EV1112	1STQ001009A0000	1/50
No.10 angled supports 1 row of terminals + earth	EV2112	1STQ003203A0000	1/10

Din rail and support for cable duct

With fixed frame for panels, maximum wiring ducts dimension is 60x60mm.

Description	Code	ABB code	Package/ No. pcs
No.4 horizontal/vertical support for cable duct	EV0042	1STQ006589A0000	1/4
No. 4 plastic supports for horizontal wiring ducts	AD1009	1STQ008200A0000	1/4

Hole covering strip RAL7035 colour

Description	Code	ABB code	Package/No. pcs
hole covers W=2000mm, grey	AD1086	1STQ009173A0000	1/10

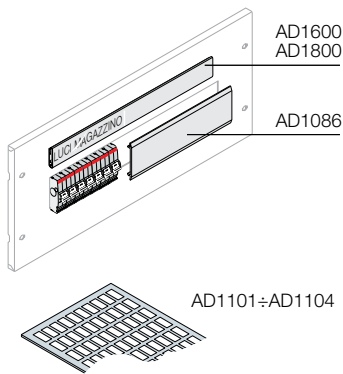

Panel Accessories

Description	Code	ABB code	Package/No. pcs
No. 20 label holders 24 DIN mod	AD1600	1STQ008205A0000	1/20
No. 20 label holders 36 DIN mod	AD1800	1STQ008206A0000	1/20
No.10 hole covers W=2000mm, grey	AD1086	1STQ009173A0000	1/10
No. 288 labels 1 DIN mod. 15x17mm (HxW)	AD1101 ⁽¹⁾	1STQ008207A0000	1/288
No. 192 labels 2 DIN mod. 15x27mm (HxW)	AD1102 ⁽¹⁾	1STQ008208A0000	1/192
No. 96 labels 3 DIN mod. 15x50mm (HxW)	AD1103 ⁽¹⁾	1STQ008209A0000	1/96
No. 96 labels 4 DIN mod. 15x67mm (HxW)	AD1104 ⁽¹⁾	1STQ008210A0000	1/96

⁽¹⁾ Labels can be written using compatible Grafoplast system.



EV1137

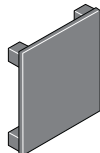

EV1135
EV1136

Closing plug for instrument holder panels

Description	Code	ABB code	Package/No. pcs
No.10 closing plug for instrument holder panels 72x72mm	EV1135	1STQ001023A0000	1/10
No.5 closing plug for instrument holder panels 96x96mm	EV1136	1STQ001024A0000	1/5
No.50 closing plugs for pushbuttons Ø22mm	EV1137	1STQ001025A0000	1/50

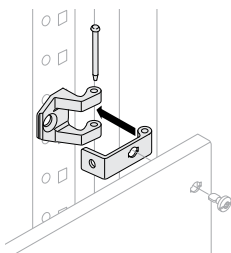

Hinges for panels

Hinges kit for panels (blind, instruments, recessed and vented panels). Not suitable for blind panels H=1800/2000mm.

Description	Code	ABB code	Package/No. pcs
No. 20 hinges for frontal panels	PHFP0020	1STQ008111A0000	1/20

For the mounting of the internal panels order the fixed PFPF... or swing PFFS.... dedicated frame

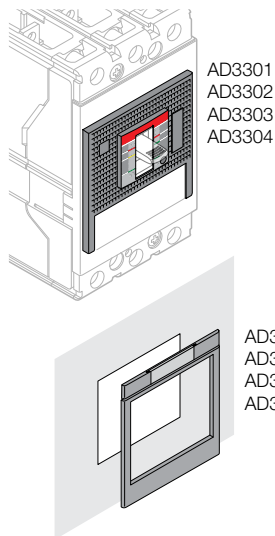

Spare parts Tmax XT cover plate for DIN rail

Description	Code	ABB code	Package/No. pcs
Cover plate for Tmax XT1 3P mounted on DIN rail	AD3301	1STQ008301A0000	1/1
Cover plate for Tmax XT1 4P mounted on DIN rail	AD3302	1STQ008302A0000	1/1
Cover plate for Tmax XT3 3P mounted on DIN rail	AD3303	1STQ008303A0000	1/1
Cover plate for Tmax XT3 4P mounted on DIN rail	AD3304	1STQ008304A0000	1/1
Cover for panel XT1 3P mounted on plate	AD3305	1STQ009216A0000	1/1
Cover for panel XT2 3P mounted on plate	AD3306	1STQ009217A0000	1/1
Cover for panel XT3 3P mounted on plate	AD3307	1STQ009218A0000	1/1
Cover for panel XT4 3P mounted on plate	AD3308	1STQ009219A0000	1/1

Screws

Description	Code	ABB code	Package/No. pcs
No. 24 1/4 turn screws with washers	PCSS0024	1STQ009183A0000	1/24

System pro *E* power

Dedicated solution

CombiLine

General information	4/2
Quick selection guide	4/4
Order codes	4/8

InLine II

General information	4/20
Quick selection guide	4/22
Order codes	4/24

System pro E power

CombiLine-M - General information

Modular distribution panel system CombiLine-M

The right module for every type of application up to 850A.

The perfect expansion of the modular cabinet series is no problem with the CombiLine-M modular distribution panel system.

Fast, efficient and easy to combine - just three product features of this system that speak for themselves.

The result: maximum options using a minimum of components.

4

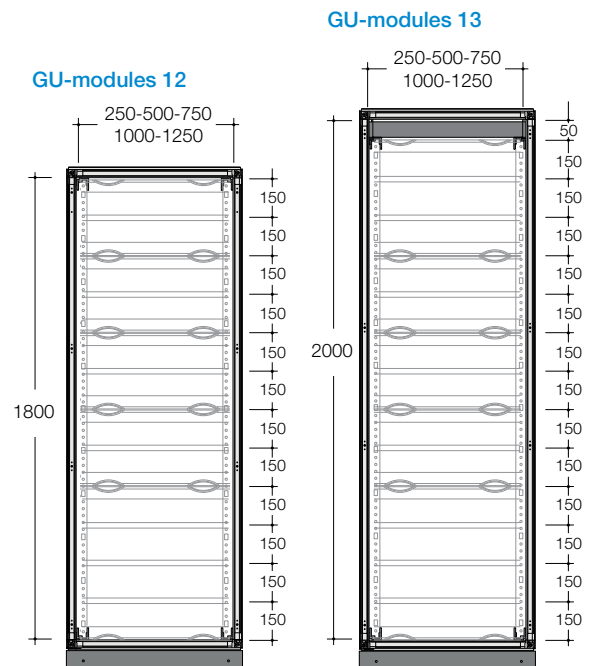

Integration in System pro E power

CombiLine-M solutions can be fitted in five different columns widths and is compatible with any enclosure depth. The fitting of CombiLine-M solutions is realized thanks to the use of a dedicated fixing set as well as a touchguard. An additional cover is needed for the enclosures with functional height 2000mm.

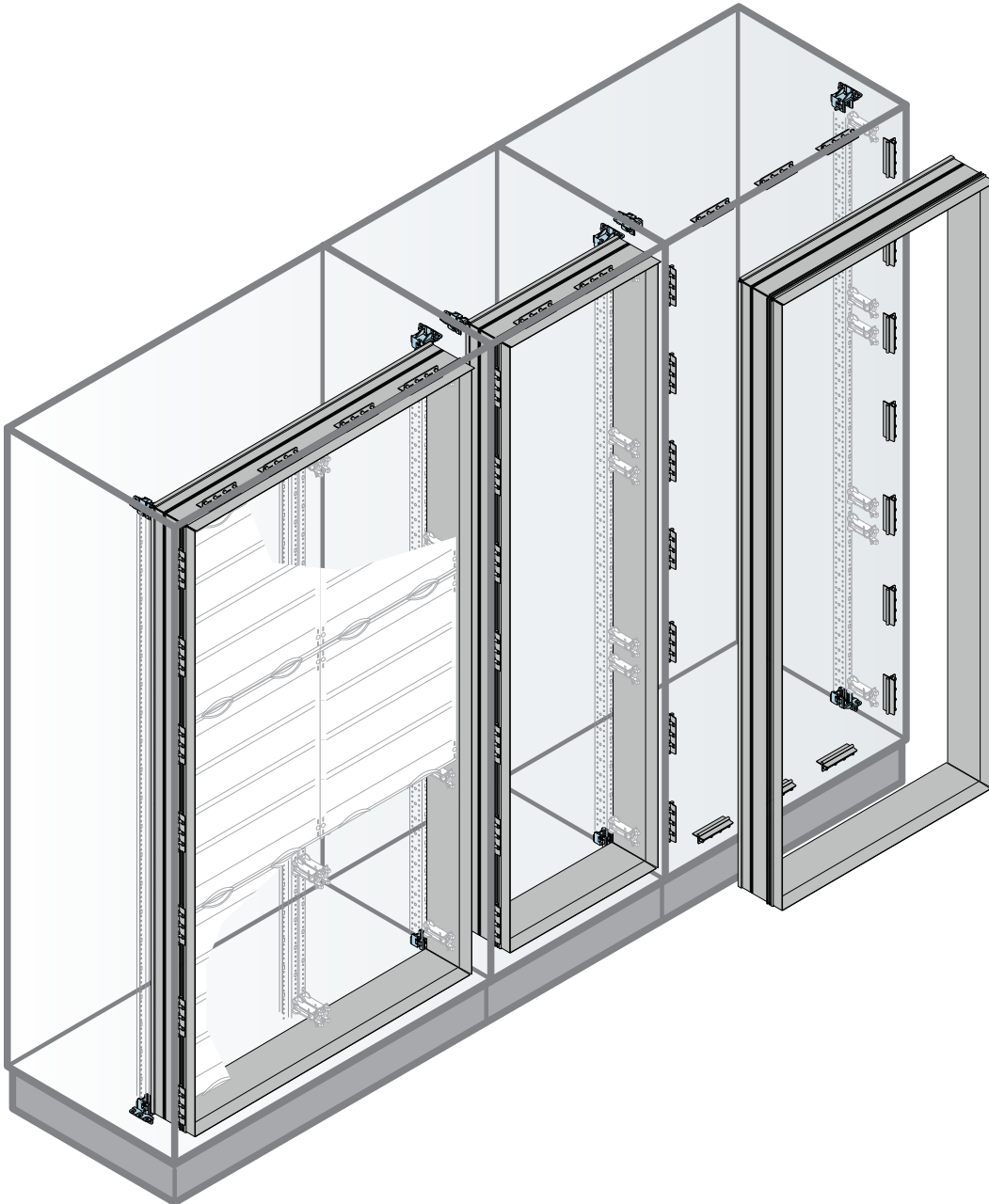

System pro E power

CombiLine-M - Quick selection guide

H=1800mm recommended installation solutions

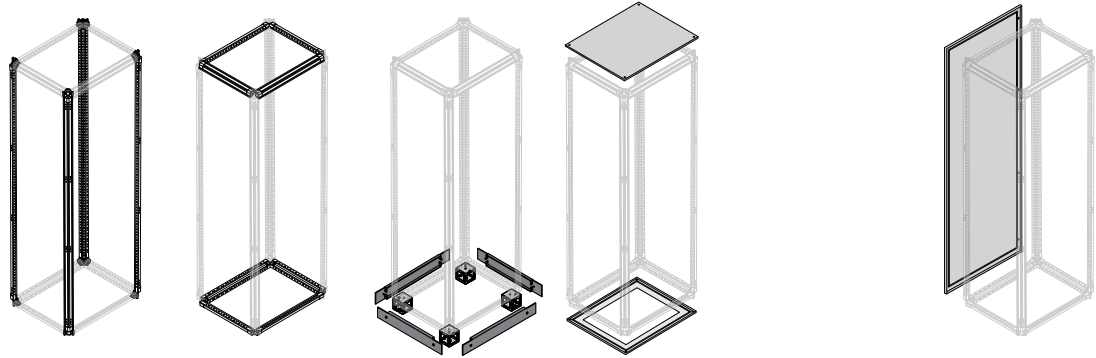

4

GU-modules 12

Functional dimensions		External dimensions *			FRAME					EXTERNAL COVERS								
Height 1800mm	W (mm)	D (mm)	Height 2013mm	W (mm)	D (mm)	PW- mod.	Galvanized sheet metal ** In≤4000A	Uprights		Structure crosspieces		H=100mm plinth		Top/bottom panels			Front/rear/side panels	
								Front/ Rear	Sides	Galvanized sheet metal In≤4000A **	Galvanized sheet metal In≤4000A **	Blind	Open ⁽²⁾	Bottom Without plinth	Rear panel			
								Angle pieces	Plinth flanges									
250	200		316	350	616	1	PUPM1800	PCFM0250	PPAM0100	PPFM1025	PCFM0200	PPFM1020	PTBB2526	PTBB2520	PTB02520	PBWP2520	PPEB1825	PPEB1827
	300		416								PCFM0300	PPFM1030	PTBB2536	PTBB2530	PTB02530	PBWP2530		
	500	500	816								PCFM0500	PPFM1050	PTBB2556	PTBB2550	PTB02550	PBWP2550		
	700		816								PCFM0700	PPFM1070	PTBB2576	PTBB2570	PTB02570	PBWP2570		
	900		1016				PCFM0900	PPFM1090	PTBB2596	PTBB2590	PTB02590	PBWP2590						
500	200		316	600	616	2	PUPM1800	PCFM0500	PPAM0100	PPFM1050	PCFM0200	PPFM1020	PTBB5026	PTBB5020	PTB05020	PBWP5020	PPEB1856	PPEB1850
	300		416								PCFM0300	PPFM1030	PTBB3056	PTBB3050	PTB03050	PBWP3050		
	500	500	816								PCFM0500	PPFM1050	PTBB5056	PTBB5050	PTB05050	PBWP5050		
	700		816								PCFM0700	PPFM1070	PTBB5076	PTBB5070	PTB05070	PBWP5070		
	900		1016				PCFM0900	PPFM1090	PTBB5096	PTBB5090	PTB05090	PBWP5090						
750	200		316	850	616	3	PUPM1800	PCFM0750	PPAM0100	PPFM1075	PCFM0200	PPFM1020	PTBB7526	PTBB7520	PTB07520	PBWP7520	PPEB1875	PPEB1877
	300		416								PCFM0300	PPFM1030	PTBB7536	PTBB7530	PTB07530	PBWP7530		
	500	500	816								PCFM0500	PPFM1050	PTBB7556	PTBB7550	PTB07550	PBWP7550		
	700		816								PCFM0700	PPFM1070	PTBB7576	PTBB7570	PTB07570	PBWP7570		
	900		1016				PCFM0900	PPFM1090	PTBB7596	PTBB7590	PTB07590	PBWP7590						
1000	200		316	1100	616	4	PUPM1800	PCFM1000	PPAM0100	PPFM1010	PCFM0200	PPFM1020	PTBB1026	PTBB1020			PPEB1816	PPEB1810
	300		416								PCFM0300	PPFM1030	PTBB1036	PTBB1030	PTB01030	PBWP1030		
	500	500	816								PCFM0500	PPFM1050	PTBB1056	PTBB1050	PTB01050	PBWP1050		
	700		816								PCFM0700	PPFM1070	PTBB1076	PTBB1070	PTB01070	PBWP1070		
	900		1016				PCFM0900	PPFM1090	PTBB1096	PTBB1090	PTB01090	PBWP1090						
1250	200		316	1350	616	5	PUPM1800	PCFM1250	PPAM0100	PPFM1250	PCFM0200	PPFM1020		PTBB1220			PPEB1820 ⁽⁴⁾	PPLB1820 ⁽⁶⁾
	300		416								PCFM0300	PPFM1030		PTBB1230	PTB01230	PBWP1230		
	500	500	816								PCFM0500	PPFM1050		PTBB1250	PTB01250	PBWP1250		
	700		816								PCFM0700	PPFM1070		PTBB1270	PTB01270	PBWP1270		
	900		1016				PCFM0900	PPFM1090		PTBB1290	PTB01290	PBWP1290						

Consult page 2/12 and 7/2 for selection of the protection class.

* The external dimensions include the H=100mm plinth and the panels.

** Also available in stainless steel, see page 2/8.

⁽¹⁾ In order to reach IPX1 protection degree it is necessary to add the proper top sealing kit, page 2/23.

⁽²⁾ Use the dedicated incoming cable flanges to obtain protection class IP65.

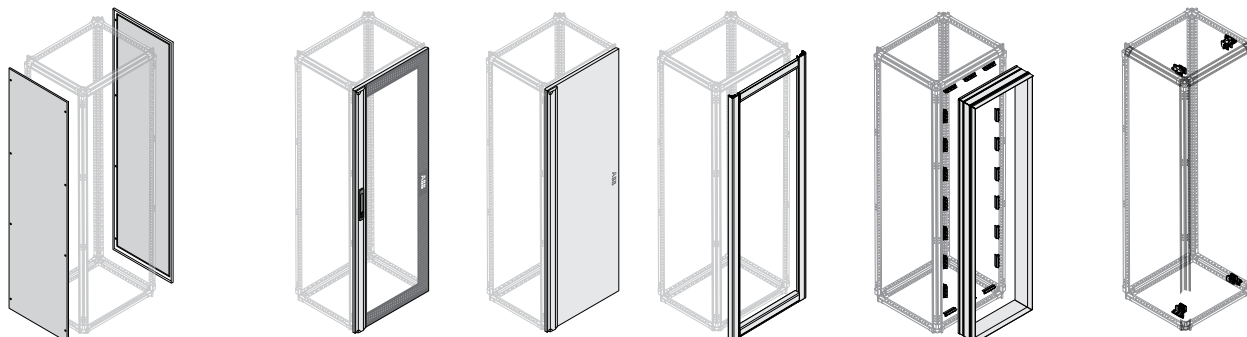

											COMBILINE					
											Finishing profiles IP30					
											Vertical profile	Horizontal profile	Touch-guard	Bracket	WR frame	Depth support ⁽⁸⁾
Vented	Side panel			Glass door 12/24/36/48 mod. DIN		Blind door 12/24/36/48 mod. DIN										
	Blind		Vented													
IP30 ⁽¹⁾	IP65	IP30 ⁽¹⁾ IP40 ⁽¹⁾	IP30 ⁽¹⁾	IP65	IP40 ⁽¹⁾	IP65	IP40 ⁽¹⁾									
	PPEB1826	PPEB1820														
	PPEB1836	PPEB1830	PPEA1830													
	PPEB1856	PPEB1850	PPEA1850			PDLB1826	PDLB1825	PPFV1800	PPFH0250	PCTG1825	PBCM0004	WR181				
	PPEB1876	PPEB1870	PPEA1870													
	PPEB1896	PPEB1890	PPEA1890													
	PPEB1826	PPEB1820														
	PPEB1836	PPEB1830	PPEA1830													
	PPEB1856	PPEB1850	PPEA1850	PDLG1856	PDLG1850	PDLB1856	PDLB1850	PPFV1800	PPFH0500	PCTG1850	PBCM0004	WR281				
	PPEB1876	PPEB1870	PPEA1870													
	PPEB1896	PPEB1890	PPEA1890													
	PPEB1826	PPEB1820														
	PPEB1836	PPEB1830	PPEA1830													
PPEA1875	PPEB1856	PPEB1850	PPEA1850	PDLG1876	PDLG1870	PDLB1876	PDLB1875	PPFV1800	PPFH0750	PCTG1875	PBCM0004	WR381				
	PPEB1876	PPEB1870	PPEA1870													
	PPEB1896	PPEB1890	PPEA1890													
	PPEB1826	PPEB1820														
	PPEB1836	PPEB1830	PPEA1830													
	PPEB1856	PPEB1850	PPEA1850	PDLG1816	PDLG1810	PDLB1816	PDLB1810	PPFV1800	PPFH1000	PCTG1810	PBCM0004	WR281 WR381	PDFC0200 PDFC0300 PDFC0500 PDFC0700 PDFC0900			
	PPEB1876	PPEB1870	PPEA1870													
	PPEB1896	PPEB1890	PPEA1890													
	PPEB1826	PPEB1820														
	PPEB1836	PPEB1830	PPEA1830													
PPRA1820 ⁽⁴⁾ PPLA1820 ⁽⁵⁾	PPEB1856	PPEB1850	PPEA1850		PDLB8120 ⁽⁶⁾ PDLG8500 ⁽⁷⁾		PDLB8120 ⁽⁶⁾ PDLB8500 ⁽⁷⁾	PPFV1800	PPFH1250	PCTG1812	PBCM0004	WR281 WR381	PDFC0200 PDFC0300 PDFC0500 PDFC0700 PDFC0900			
	PPEB1876	PPEB1870	PPEA1870													
	PPEB1896	PPEB1890	PPEA1890													

⁽³⁾ Bottom for switchboard without plinth complete with the dedicated set of brackets, which can be ordered separately.

⁽⁴⁾ Right rear panel for structures W=1250mm.

⁽⁵⁾ Left rear panel for structures W=1250mm.

⁽⁶⁾ Door with overlapping for the double door version.

⁽⁷⁾ Door with handle for the double door version.

⁽⁸⁾ Order the RZ1P4 older for two frame.

This are standard configurations can be calculated with the software.

System pro E power

CombiLine-M - Quick selection guide

H=2000mm recommended installation solutions

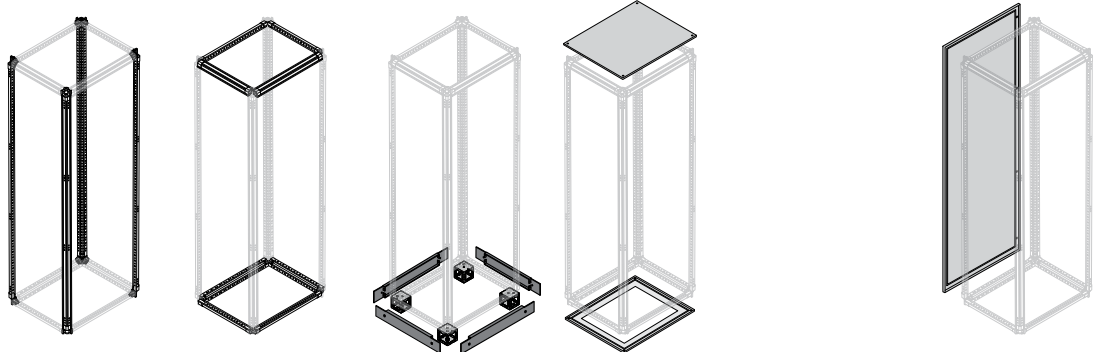

4

GU-modules 13

Functional dimensions		External dimensions *			FRAME					EXTERNAL COVERS													
Height 2000mm	W (mm)	D (mm)	Height 2213mm		PW- mod.	Galvanized sheet metal ** In≤4000A	Uprights		Structure crosspieces		H=100mm plinth			Top/bottom panels			Front/rear/side panels						
			W (mm)	D (mm)			Front/ Rear	Sides	Galvanized sheet metal In≤4000A **	Galvanized sheet metal In≤4000A **	Angle pieces	Plinth flanges	Blind	Open ⁽²⁾	Bottom Without plinth	Rear panel	Blind	IP30 ⁽¹⁾ IP40 ⁽¹⁾					
250	200	316	350	316	1	PUPM2000	PCFM0250	PCFM0200	PCFM0300	PPAM0100	PPFM1025	PTBB2526	PTBB2520	PTB02520	PBWP2520	PPEB2025	PPEB2027						
	300	416																					
	500	616																					
	700	816																					
500	200	316	600	316	2	PUPM2000	PCFM0500	PCFM0200	PCFM0300	PPAM0100	PPFM1050	PTBB5026	PTBB5020	PTB05020	PBWP5020	PPEB2056	PPEB2050						
	300	416																					
	500	616																					
	700	816																					
750	200	316	850	316	3	PUPM2000	PCFM0750	PCFM0200	PCFM0300	PPAM0100	PPFM1075	PTBB7526	PTBB7520	PTB07520	PBWP7520	PPEB2075	PPEB2077						
	300	416																					
	500	616																					
	700	816																					
1000	200	316	1100	316	4	PUPM2000	PCFM1000	PCFM0200	PCFM0300	PPAM0100	PPFM1010	PTBB1026	PTBB1020	PTB01030	PBWP1030	PPEB2016	PPEB2010						
	300	416																					
	500	616																					
	700	816																					
1250	200	316	1350	316	5	PUPM2000	PCFM1250	PCFM0200	PCFM0300	PPAM0100	PPFM1250	PTBB1220	PTBB1230	PTB01230	PBWP1230	PPRB2020 ⁽⁴⁾	PPLB2020 ⁽⁵⁾						
	300	416																					
	500	616																					
	700	816																					
	900	1016		1016			PCFM0500	PCFM0700	PCFM0900			PPFM1050	PPFM1070	PPFM1090	PTBB1250	PTBB1270	PTBB1290	PTB01250	PTB01270	PTB01290	PBWP1250	PBWP1270	PBWP1290

Consult page 2/12 and 7/2 for selection of the protection class.

* The external dimensions include the H=100mm plinth and the panels.

** Also available in stainless steel, see page 2/8.

⁽¹⁾ In order to reach IPX1 protection degree it is necessary to add the proper top sealing kit, page 2/23.

⁽²⁾ Use the dedicated incoming cable flanges to obtain protection class IP65.

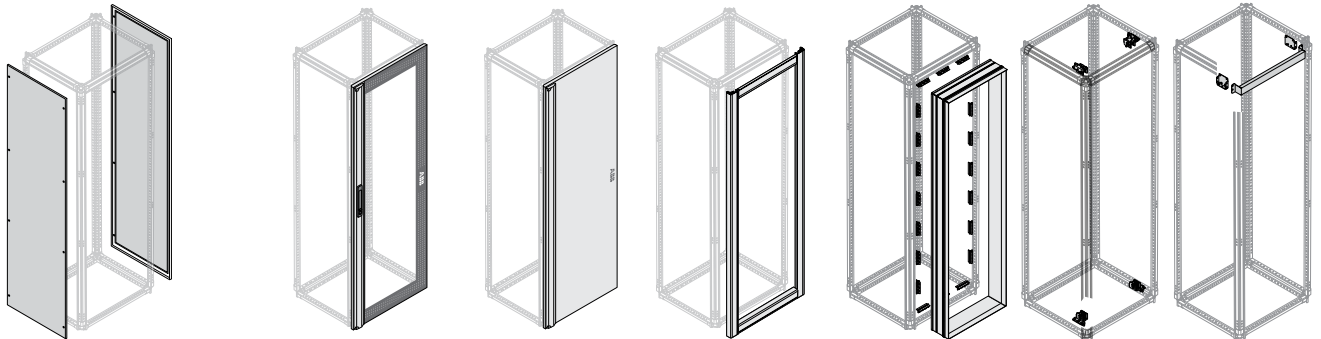

													COMBILINE			
													Finishing profiles IP30			
Vented	Side panel			Glass door 12/24/36/48 mod. DIN		Blind door 12/24/36/48 mod. DIN		Vertical profile	Horizontal profile	Touch-guard	Bracket	Adaptor for height 2000mm	WR frame	Depth support ⁽⁸⁾		
	Blind	Vented		IP65	IP40 ⁽¹⁾	IP65	IP40 ⁽¹⁾								Vertical profile	Horizontal profile
IP30 ⁽¹⁾	IP65	IP30 ⁽¹⁾	IP30 ⁽¹⁾	IP65	IP40 ⁽¹⁾	IP65	IP40 ⁽¹⁾	Vertical profile	Horizontal profile	Touch-guard	Bracket	Adaptor for height 2000mm	WR frame	Depth support ⁽⁸⁾		
	PPEB2026	PPEB2020														
	PPEB2036	PPEB2030	PPEA2030													
	PPEB2056	PPEB2050	PPEA2050			PDLB2026	PDLB2025	PPFV2000	PPFH0250	PCTG2025	PBCM0004	PCCM2025	WR191			
	PPEB2076	PPEB2070	PPEA2070													
	PPEB2096	PPEB2090	PPEA2090													
	PPEB2026	PPEB2020														
	PPEB2036	PPEB2030	PPEA2030													
	PPEB2056	PPEB2050	PPEA2050	PDLG2056	PDLG2050	PDLB2056	PDLB2050	PPFV2000	PPFH0500	PCTG2050	PBCM0004	PCCM2050	WR291			
	PPEB2076	PPEB2070	PPEA2070													
	PPEB2096	PPEB2090	PPEA2090													
PPEA2075	PPEB2026	PPEB2020														
	PPEB2036	PPEB2030	PPEA2030													
	PPEB2056	PPEB2050	PPEA2050	PDLG2076	PDLG2070	PDLB2076	PDLB2075	PPFV2000	PPFH0750	PCTG2075	PBCM0004	PCCM2075	WR391			
	PPEB2076	PPEB2070	PPEA2070													
	PPEB2096	PPEB2090	PPEA2090													
	PPEB2026	PPEB2020												PDFC0200		
	PPEB2036	PPEB2030	PPEA2030											PDFC0300		
	PPEB2056	PPEB2050	PPEA2050	PDLG2016	PDLG2010	PDLB2016	PDLB2010	PPFV2000	PPFH1000	PCTG2010	PBCM0004	PCCM2010	WR291 WR391	PDFC0500		
	PPEB2076	PPEB2070	PPEA2070											PDFC0700		
	PPEB2096	PPEB2090	PPEA2090											PDFC0900		
PPRA2020 ⁽⁴⁾	PPEB2026	PPEB2020												PDFC0200		
PPLA2020 ⁽⁵⁾	PPEB2036	PPEB2030	PPEA2030			PDLB2120 ⁽⁶⁾	PDLB2120 ⁽⁶⁾	PPFV2000	PPFH1250	PCTG2012	PBCM0004	PCCM2012	WR291 WR391	PDFC0300		
	PPEB2056	PPEB2050	PPEA2050			PDLG2500 ⁽⁷⁾	PDLB2500 ⁽⁷⁾	PPFV2000	PPFH1250	PCTG2012	PBCM0004	PCCM2012	WR291 WR391	PDFC0500		
	PPEB2076	PPEB2070	PPEA2070											PDFC0700		
	PPEB2096	PPEB2090	PPEA2090											PDFC0900		

⁽⁸⁾ Bottom for switchboard without plinth complete with the dedicated set of brackets, which can be ordered separately.

⁽⁴⁾ Right rear panel for structures W=1250mm.

⁽⁶⁾ Left rear panel for structures W=1250mm.

⁽⁶⁾ Door with overlapping for the double door version.

⁽⁷⁾ Door with handle for the double door version.

⁽⁸⁾ Order the RZ1P4 older for two frame and PBMC0001 adaptor for CombiLine H=2000mm.

This are standard configurations can be calculated with the software.

System pro E power

CombiLine-M - Order codes

4

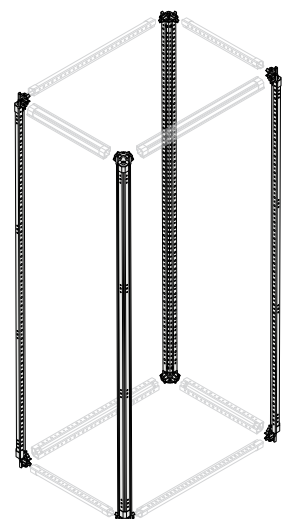
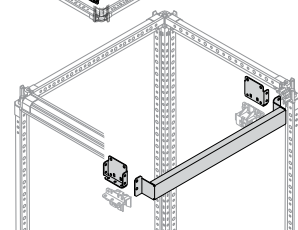
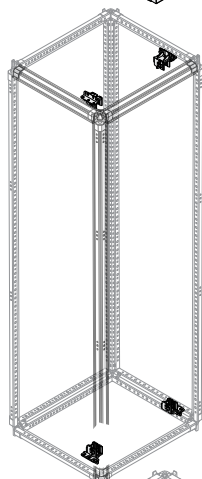
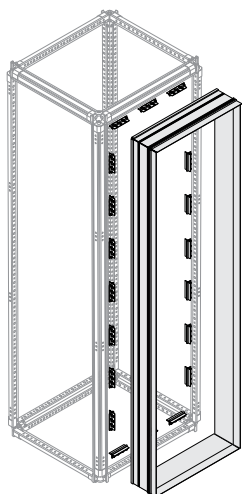

Touch guard profile - dedicated solution for CombiLine-M

Profile to guarantee IP20 touch protection with CombiLine-M modules installed.

Description	Dimensions (mm)		Order code	ABB code	Package/ No. pcs
	H	W			
Touch Guard profile	1800	250	PCTG1825	1STQ009368A0000	1/1
Touch Guard profile	1800	500	PCTG1850	1STQ009406A0000	1/1
Touch Guard profile	1800	750	PCTG1875	1STQ009385A0000	1/1
Touch Guard profile	1800	1000	PCTG1810	1STQ009928A0000	1/1
Touch Guard profile	1800	1250	PCTG1812	1STQ001319B0000	1/1
Touch Guard profile	2000	250	PCTG2025	1STQ009379A0000	1/1
Touch Guard profile	2000	500	PCTG2050	1STQ009417A0000	1/1
Touch Guard profile	2000	750	PCTG2075	1STQ009399A0000	1/1
Touch Guard profile	2000	1000	PCTG2010	1STQ009929A0000	1/1
Touch Guard profile	2000	1250	PCTG2012	1STQ001320B0000	1/1

Fixing set - dedicated solution for CombiLine-M

Fixed set for the adaptation of standard WR frame on System pro E power structure.

Description	Order code	ABB code	Package/ No. pcs
CombiLine-M fixing set	PBCM0004	1STQ009354A0000	1/4
Depth support			
No.2 CombiLine crosspieces for frame D=200mm	PDFC0200	1STQ001929B0000	1/2
No.2 CombiLine crosspieces for frame D=300mm	PDFC0300	1STQ001930B0000	1/2
No.2 CombiLine crosspieces for frame D=500mm	PDFC0500	1STQ001931B0000	1/2
No.2 CombiLine crosspieces for frame D=700mm	PDFC0700	1STQ001932B0000	1/2
No.2 CombiLine crosspieces for frame D=900mm	PDFC0900	1STQ001933B0000	1/2
No.2 adaptor for CombiLine H=2000mm	PBMC0001	1STQ001934B0000	1/2

Height adapters for 2000mm columns - dedicated solution for CombiLine-M

Adaptors to use CombiLine-M modules in columns with functional height 2000mm. The components cover 50mm on the bottom and on the top.

Description	Dimensions (mm)		Order code	ABB code	Package/ No. pcs
	H	W			
CombiLine-M adapter	2000	250	PCCM2025	1STQ009355A0000	1/2
CombiLine-M adapter	2000	500	PCCM2050	1STQ009356A0000	1/2
CombiLine-M adapter	2000	750	PCCM2075	1STQ009357A0000	1/2
CombiLine-M adapter	2000	1000	PCCM2010	1STQ009358A0000	1/2
CombiLine-M adapter	2000	1250	PCCM2012	1STQ001318B0000	1/2

Uprights – Galvanized sheet metal *

Upright formed by a closed profile made of galvanized sheet metal. The uprights include 8 already assembled 3-way joints, 8 already assembled axial screws and 16 loose axial screws. For applications with $I_n \leq 4000A$.

Description	Dimensions		Order code	Codice ABB	Package/ No. pcs
	H (mm)				
No.4 galvanized sheet metal uprights	1800		PUPM1800	1STQ007033A0000	1/4
No.4 galvanized sheet metal uprights	2000		PUPM2000	1STQ007034A0000	1/4

* Also available in stainless steel, see page 2/15.

> Quick selection guides page 4/4

> Technical details page 7/1

> Overall dimensions page 8/1

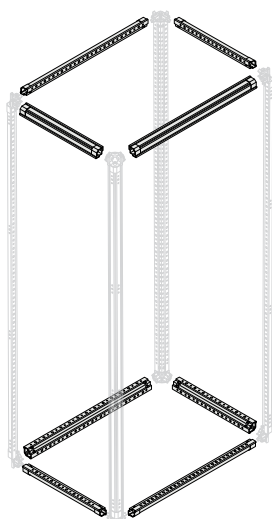

Structure crosspieces – Galvanized sheet metal *

Depth and width crosspieces for structures in galvanized sheet metal. For applications with $I_n \leq 4000A$.

Description	Dimensions (mm)		Order code	ABB code	Package/ No. pcs
	W	D			
Width crosspieces					
No.4 width crosspieces galvanized sheet metal	250		PCFM0250	1STQ007036A0000	1/4
No.4 width crosspieces galvanized sheet metal	500		PCFM0500	1STQ007039A0000	1/4
No.4 width crosspieces galvanized sheet metal	750		PCFM0750	1STQ007041A0000	1/4
No.4 width crosspieces galvanized sheet metal	1000		PCFM1000	1STQ007043A0000	1/4
No.4 width crosspieces galvanized sheet metal	1250		PCFM1250	1STQ007044A0000	1/4
Depth crosspieces					
No.4 width crosspieces galvanized sheet metal		200	PCFM0200	1STQ007045A0000	1/4
No.4 width crosspieces galvanized sheet metal		300	PCFM0300	1STQ007037A0000	1/4
No.4 width crosspieces galvanized sheet metal		500	PCFM0500	1STQ007039A0000	1/4
No.4 width crosspieces galvanized sheet metal		700	PCFM0700	1STQ007046A0000	1/4
No.4 width crosspieces galvanized sheet metal		900	PCFM0900	1STQ007047A0000	1/4

* Also available in stainless steel, see page 2/15.

PPAM0100

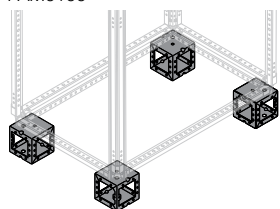

Universal angle pieces for plinths in galvanized sheet metal

Not pre-assembled to the structure. New angle piece with high mechanical strength. Can be fixed from the outside and from the inside of the structure even at a later date. Equipped with anti-rotation system and bottom that can be transported with a transpallet.

PPAM0200

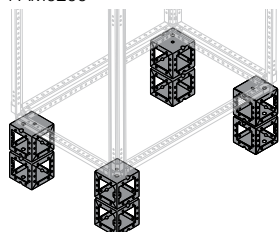

Description	Dimensions H (mm)	Order code	ABB code	Package/ No. pcs
No.4 plinth angle pieces	100	PPAM0100	1STQ007048A0000	1/4
No.8 plinth angle pieces H=100mm pre-assembled*	200	PPAM0200	1STQ007207A0000	1/4

*Order no. 2 pieces of H=100mm covering flange kits to complete the H=200mm plinth.

Plinth flanges

Side and front/rear plinth flanges H=100mm RAL 7012.

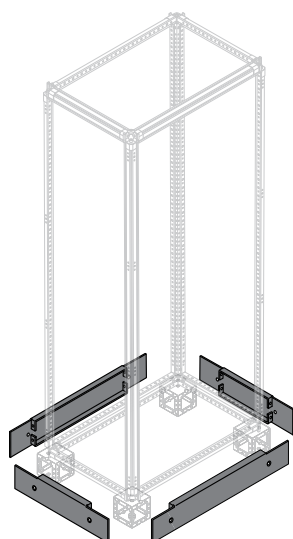

Description	Dimensions (mm)		Order code	ABB code	Package/ No. pcs
	W	D			
Front/rear plinth flanges					
No.2 plinth flanges	250		PPFM1025	1STQ007049A0000	1/2
No.2 plinth flanges	500		PPFM1050	1STQ007052A0000	1/2
No.2 plinth flanges	750		PPFM1075	1STQ007054A0000	1/2
No.2 plinth flanges	1000		PPFM1010	1STQ007056A0000	1/2
No.4 plinth flanges	1250		PPFM1250	1STQ007057A0000	1/4
Side plinth flanges					
No.2 plinth flanges		200	PPFM1020	1STQ007058A0000	1/2
No.2 plinth flanges		300	PPFM1030	1STQ007050A0000	1/2
No.2 plinth flanges		500	PPFM1050	1STQ007052A0000	1/2
No.2 plinth flanges		700	PPFM1070	1STQ007059A0000	1/2
No.2 plinth flanges		900	PPFM1090	1STQ007060A0000	1/2

System pro E power

CombiLine-M - Order codes

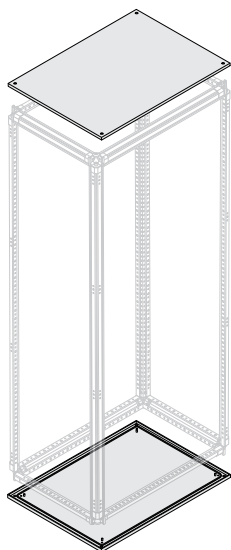

Blind Top/Bottom IP65 – Pickled sheet steel

Pickled sheet steel with IP65 gasket. The article comprises one single component that can be used as either a top or bottom. In order to purchase both the top and the bottom, please order two quantities of the same code or two different top/bottom codes according to the desired design of the structure. The code includes four M12x20 screws.

Description	Dimensions (mm)		Order code	ABB code	Package/ No. pcs
	W	D			
IP65 blind top/bottom	250	200	PTBB2526	1STQ001270B0000	1/1
IP65 blind top/bottom	250	300	PTBB2536	1STQ007071A0000	1/1
IP65 blind top/bottom	250	500	PTBB2556	1STQ007072A0000	1/1
IP65 blind top/bottom	250	700	PTBB2576	1STQ007073A0000	1/1
IP65 blind top/bottom	250	900	PTBB2596	1STQ001271B0000	1/1
IP65 blind top/bottom	500	200	PTBB5026	1STQ001284B0000	1/1
IP65 blind top/bottom	500	300	PTBB3056	1STQ007076A0000	1/1
IP65 blind top/bottom	500	500	PTBB5050	1STQ009179A0000	1/1
IP65 blind top/bottom	500	700	PTBB5076	1STQ007085A0000	1/1
IP65 blind top/bottom	500	900	PTBB5096	1STQ001286B0000	1/1
IP65 blind top/bottom	750	200	PTBB7526	1STQ001303B0000	1/1
IP65 blind top/bottom	750	300	PTBB7536	1STQ007091A0000	1/1
IP65 blind top/bottom	750	500	PTBB7556	1STQ007092A0000	1/1
IP65 blind top/bottom	750	700	PTBB7576	1STQ007093A0000	1/1
IP65 blind top/bottom	750	900	PTBB7596	1STQ001304B0000	1/1
Blind Top/Bottom IP65	1000	200	PTBB1026	1STQ009178A0000	1/1
Blind Top/Bottom IP65	1000	300	PTBB1036	1STQ007099A0000	1/1
Blind Top/Bottom IP65	1000	500	PTBB1056	1STQ007100A0000	1/1
Blind Top/Bottom IP65	1000	700	PTBB1076	1STQ007101A0000	1/1
Blind Top/Bottom IP65	1000	900	PTBB1096	1STQ007102A0000	1/1

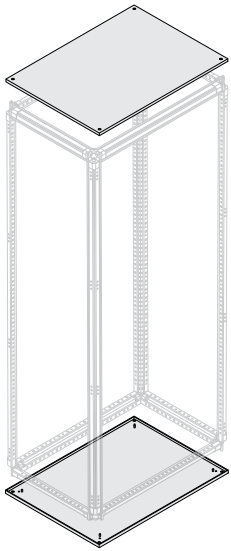

Blind Top/Bottom IP30, IP40 – Pickled sheet steel

Pickled sheet steel without gasket. In order to reach IPX1 protection degree it is necessary to add the proper top sealing kit, page 4/12.

The article comprises one single component that can be used as either a top or bottom. In order to purchase both the top and the bottom, please order two quantities of the same code or two different top/bottom codes according to the desired design of the structure. The code includes four M12x20 screws.

Description	Dimensions (mm)		Order code	ABB code	Package/ No. pcs
	W	D			
Blind Top/Bottom IP30, 40	250	200	PTBB2520	1STQ001267B0000	1/1
Blind Top/Bottom IP30, 40	250	300	PTBB2530	1STQ001268B0000	1/1
Blind Top/Bottom IP30, 40	250	500	PTBB2550	1STQ009370A0000	1/1
Blind Top/Bottom IP30, 40	250	700	PTBB2570	1STQ009423A0000	1/1
Blind Top/Bottom IP30, 40	250	900	PTBB2590	1STQ001269B0000	1/1
Blind Top/Bottom IP30, 40	500	200	PTBB5020	1STQ001281B0000	1/1
Blind Top/Bottom IP30, 40	500	300	PTBB3050	1STQ007109A0000	1/1
Blind Top/Bottom IP30, 40	500	500	PTBB5057	1STQ009407A0000	1/1
Blind Top/Bottom IP30, 40	500	700	PTBB5070	1STQ009435A0000	1/1
Blind Top/Bottom IP30, 40	500	900	PTBB5090	1STQ001283B0000	1/1
Blind Top/Bottom IP30, 40	750	200	PTBB7520	1STQ001300B0000	1/1
Blind Top/Bottom IP30, 40	750	300	PTBB7530	1STQ001301B0000	1/1
Blind Top/Bottom IP30, 40	750	500	PTBB7550	1STQ009387A0000	1/1
Blind Top/Bottom IP30, 40	750	700	PTBB7570	1STQ009429A0000	1/1
Blind Top/Bottom IP30, 40	750	900	PTBB7590	1STQ001302B0000	1/1
Blind Top/Bottom IP30, 40	1000	200	PTBB1020	1STQ009152A0000	1/1
Blind Top/Bottom IP30, 40	1000	300	PTBB1030	1STQ007127A0000	1/1
Blind Top/Bottom IP30, 40	1000	500	PTBB1050	1STQ007128A0000	1/1
Blind Top/Bottom IP30, 40	1000	700	PTBB1070	1STQ007129A0000	1/1
Blind Top/Bottom IP30, 40	1000	900	PTBB1090	1STQ007130A0000	1/1
Blind Top/Bottom IP30, 40	1250	200	PTBB1220	1STQ009153A0000	1/1
Blind Top/Bottom IP30, 40	1250	300	PTBB1230	1STQ001315B0000	1/1
Blind Top/Bottom IP30, 40	1250	500	PTBB1250	1STQ001316B0000	1/1
Blind Top/Bottom IP30, 40	1250	700	PTBB1270	1STQ001317B0000	1/1
Blind Top/Bottom IP30, 40	1250	900	PTBB1290	1STQ007131A0000	1/1

System pro E power

CombiLine-M - Order codes

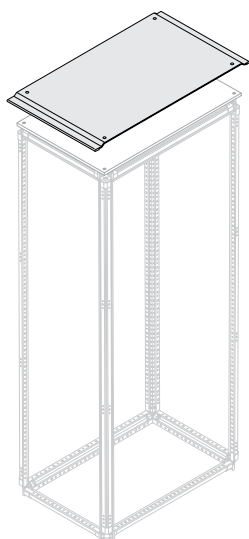

Top sealing kit IP31/IP41

Profiles for IP31/IP41 for top.

Description	Dimensions (mm)		Order code	ABB code	Package/ No. pcs
	W	D			
Top sealing kit IP31/IP41	250	200	PKPT2520	1STQ001276B0000	1/1
Top sealing kit IP31/IP41	250	300	PKPT2530	1STQ001277B0000	1/1
Top sealing kit IP31/IP41	250	500	PKPT2550	1STQ009371A0000	1/1
Top sealing kit IP31/IP41	250	700	PKPT2570	1STQ009424A0000	1/1
Top sealing kit IP31/IP41	250	900	PKPT2590	1STQ001278B0000	1/1
Top sealing kit IP31/IP41	500	200	PKPT5020	1STQ001294B0000	1/1
Top sealing kit IP31/IP41	500	300	PKPT5030	1STQ001295B0000	1/1
Top sealing kit IP31/IP41	500	500	PKPT5050	1STQ009408A0000	1/1
Top sealing kit IP31/IP41	500	700	PKPT5070	1STQ009436A0000	1/1
Top sealing kit IP31/IP41	500	900	PKPT5090	1STQ001296B0000	1/1
Top sealing kit IP31/IP41	750	200	PKPT7520	1STQ001310B0000	1/1
Top sealing kit IP31/IP41	750	300	PKPT7530	1STQ001311B0000	1/1
Top sealing kit IP31/IP41	750	500	PKPT7550	1STQ009388A0000	1/1
Top sealing kit IP31/IP41	750	700	PKPT7570	1STQ009430A0000	1/1
Top sealing kit IP31/IP41	750	900	PKPT7590	1STQ001312B0000	1/1
Top sealing kit IP31/IP41	1000	200	PKPT1020	1STQ009176A0000	1/1
Top sealing kit IP31/IP41	1000	300	PKPT1030	1STQ008081A0000	1/1
Top sealing kit IP31/IP41	1000	500	PKPT1050	1STQ008082A0000	1/1
Top sealing kit IP31/IP41	1000	700	PKPT1070	1STQ008083A0000	1/1
Top sealing kit IP31/IP41	1000	900	PKPT1090	1STQ008084A0000	1/1
Top sealing kit IP31/IP41	1250	300	PKPT1230	1STQ001321B0000	1/1
Top sealing kit IP31/IP41	1250	500	PKPT1250	1STQ001322B0000	1/1
Top sealing kit IP31/IP41	1250	700	PKPT1270	1STQ001323B0000	1/1
Top sealing kit IP31/IP41	1250	900	PKPT1259	1STQ008085A0000	1/1

Open Top/Bottom

Pickled sheet steel with holes. The code comprises one single component that can be used as either a top or bottom. In order to purchase both the top and the bottom, please order two quantities of the same code or two different top/bottom codes according to the desired design of the structure.

In order to reach IP65 protection degree, use the dedicated fixed cable incoming flanges PFCF...; in order to reach IP40 protection degree, use the dedicated swinging cable incoming flanges PFCS.... at page 4/13-4/14. The use of the single open top/bottom without flanges does not guarantee any degree of protection IP. The open top/bottom, associated with sliding flanges, is incompatible with crosspieces assembled inside the cable compartment.

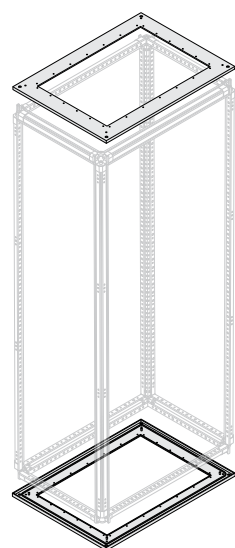

Description	Dimensions (mm)		Order code	ABB code	Package/ No. pcs
	W	D			
Open Top/Bottom	250	200	PTBO2520	1STQ001272B0000	1/1
Open Top/Bottom	250	300	PTBO2530	1STQ007132A0000	1/1
Open Top/Bottom	250	500	PTBO2550	1STQ007133A0000	1/1
Open Top/Bottom	250	700	PTBO2570	1STQ007134A0000	1/1
Open Top/Bottom	250	900	PTBO2590	1STQ001273B0000	1/1
Open Top/Bottom	500	200	PTBO5020	1STQ001287B0000	1/1
Open Top/Bottom	500	300	PTBO3050	1STQ007137A0000	1/1
Open Top/Bottom	500	500	PTBO5050	1STQ007145A0000	1/1
Open Top/Bottom	500	700	PTBO5070	1STQ007146A0000	1/1
Open Top/Bottom	500	900	PTBO5090	1STQ001289B0000	1/1
Open Top/Bottom	750	200	PTBO7520	1STQ001305B0000	1/1
Open Top/Bottom	750	300	PTBO7530	1STQ007152A0000	1/1
Open Top/Bottom	750	500	PTBO7550	1STQ007153A0000	1/1
Open Top/Bottom	750	700	PTBO7570	1STQ007154A0000	1/1
Open Top/Bottom	750	900	PTBO7590	1STQ001306B0000	1/1
Open Top/Bottom	1000	300	PTBO1030	1STQ007160A0000	1/1
Open Top/Bottom	1000	500	PTBO1050	1STQ007161A0000	1/1
Open Top/Bottom	1000	700	PTBO1070	1STQ007162A0000	1/1
Open Top/Bottom	1000	900	PTBO1090	1STQ007163A0000	1/1
Open Top/Bottom	1250	300	PTBO1230	1STQ007164A0000	1/1
Open Top/Bottom	1250	500	PTBO1250	1STQ007165A0000	1/1
Open Top/Bottom	1250	700	PTBO1270	1STQ007166A0000	1/1
Open Top/Bottom	1250	900	PTBO1290	1STQ007167A0000	1/1

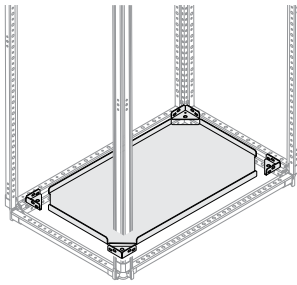

Bottom without plinth IP40

Internal galvanized steel bottom with special brackets kit included (special brackets kit available also as spare part with the code PBRB0004). In order to reach IPX1 protection degree it is necessary to add the proper top sealing kit PKPT..., page 4/12.

Description	Dimensions (mm)		Order code	ABB code	Package/ No. pcs
	W	D			
Bottom without plinth IP40	250	200	PBWP2520	1STQ001279B0000	1/1
Bottom without plinth IP40	250	300	PBWP2530	1STQ007168A0000	1/1
Bottom without plinth IP40	250	500	PBWP2550	1STQ007169A0000	1/1
Bottom without plinth IP40	250	700	PBWP2570	1STQ007170A0000	1/1
Bottom without plinth IP40	250	900	PBWP2590	1STQ001280B0000	1/1
Bottom without plinth IP40	500	200	PBWP5020	1STQ001297B0000	1/1
Bottom without plinth IP40	500	300	PBWP3050	1STQ007173A0000	1/1
Bottom without plinth IP40	500	500	PBWP5050	1STQ007181A0000	1/1
Bottom without plinth IP40	500	700	PBWP5070	1STQ007182A0000	1/1
Bottom without plinth IP40	500	900	PBWP5090	1STQ001299B0000	1/1
Bottom without plinth IP40	750	200	PBWP7520	1STQ001313B0000	1/1
Bottom without plinth IP40	750	300	PBWP7530	1STQ007188A0000	1/1
Bottom without plinth IP40	750	500	PBWP7550	1STQ007189A0000	1/1
Bottom without plinth IP40	750	700	PBWP7570	1STQ007190A0000	1/1
Bottom without plinth IP40	750	900	PBWP7590	1STQ001314B0000	1/1
Bottom without plinth IP40	1000	300	PBWP1030	1STQ007196A0000	1/1
Bottom without plinth IP40	1000	500	PBWP1050	1STQ007197A0000	1/1
Bottom without plinth IP40	1000	700	PBWP1070	1STQ007198A0000	1/1
Bottom without plinth IP40	1000	900	PBWP1090	1STQ007199A0000	1/1
Bottom without plinth IP40	1250	300	PBWP1230	1STQ007200A0000	1/1
Bottom without plinth IP40	1250	500	PBWP1250	1STQ007201A0000	1/1
Bottom without plinth IP40	1250	700	PBWP1270	1STQ007202A0000	1/1
Bottom without plinth IP40	1250	900	PBWP1290	1STQ007203A0000	1/1

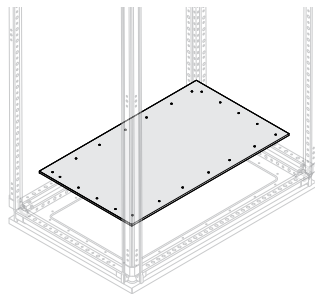

Fixed incoming cable flange

Fixed incoming cable flange in sheet metal to use in conjunction with the open bottom to guarantee IP65 protection class. With internal cable compartment crosspieces it is necessary to mount the fixed flange first.

Description	Dimensioni (mm)		Order code	ABB code	Package/ No. pcs
	W	D			
Fixed incoming cable flange	250	200	PFCF2520	1STQ001274B0000	1/1
Fixed incoming cable flange	250	300	PFCF2530	1STQ007655A0000	1/1
Fixed incoming cable flange	250	500	PFCF2550	1STQ007656A0000	1/1
Fixed incoming cable flange	250	700	PFCF2570	1STQ007657A0000	1/1
Fixed incoming cable flange	250	900	PFCF2590	1STQ001275B0000	1/1
Fixed incoming cable flange	500	200	PFCF5020	1STQ001290B0000	1/1
Fixed incoming cable flange	500	300	PFCF3050	1STQ007660A0000	1/1
Fixed incoming cable flange	500	500	PFCF5050	1STQ007668A0000	1/1
Fixed incoming cable flange	500	700	PFCF5070	1STQ007669A0000	1/1
Fixed incoming cable flange	500	900	PFCF5090	1STQ001292B0000	1/1
Fixed incoming cable flange	750	200	PFCF7520	1STQ001307B0000	1/1
Fixed incoming cable flange	750	300	PFCF7530	1STQ007675A0000	1/1
Fixed incoming cable flange	750	500	PFCF7550	1STQ007676A0000	1/1
Fixed incoming cable flange	750	700	PFCF7570	1STQ007677A0000	1/1
Fixed incoming cable flange	750	900	PFCF7590	1STQ001308B0000	1/1
Fixed incoming cable flange	1000	300	PFCF1030	1STQ007683A0000	1/1
Fixed incoming cable flange	1000	500	PFCF1050	1STQ007684A0000	1/1
Fixed incoming cable flange	1000	700	PFCF1070	1STQ007685A0000	1/1
Fixed incoming cable flange	1000	900	PFCF1090	1STQ007686A0000	1/1
Fixed incoming cable flange	1250	900	2xPFCF6090	1STQ007674A0000	1/1

System pro E power

CombiLine-M - Order codes

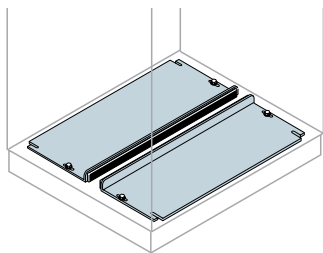

Sliding incoming cable flanges in sheet metal

Sliding incoming cable flanges in sheet metal to use in conjunction with the open bottom to guarantee IP40 protection class. It is not possible to assemble the sliding flanges in structures with internal cable compartment.

Description	Dimensioni (mm)		Order code	ABB code	Package/ No. pcs
	W	D			
No.2 sliding flanges	500	500	PFCS5050	1STQ007702A0000	1/2
No.2 sliding flanges	500	700	PFCS5070	1STQ007703A0000	1/2
No.2 sliding flanges	500	900	PFCS5090	1STQ001293B0000	1/2
No.2 sliding flanges	750	500	PFCS7550	1STQ007709A0000	1/2
No.2 sliding flanges	750	700	PFCS7570	1STQ007710A0000	1/2
No.2 sliding flanges	750	900	PFCS7590	1STQ001309B0000	1/2
No.2 sliding flanges	1000	500	PFCS1050	1STQ007716A0000	1/2
No.2 sliding flanges	1000	700	PFCS1070	1STQ007717A0000	1/2
No.2 sliding flanges	1000	900	PFCS1090	1STQ007718A0000	1/2
No.2 sliding flanges	1250	900	2xPFCS6090	1STQ007707A0000	1/2

4

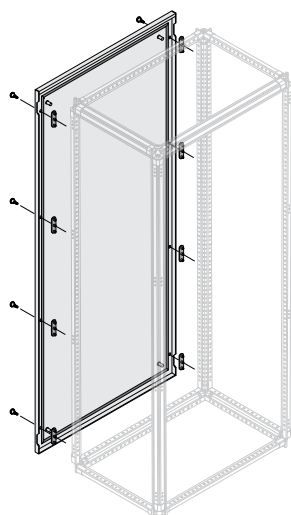

External blind rear panel IP65

Pickled sheet steel with gasket and plugs IP65.

Description	Dimensions (mm)		Order code	ABB code	Package/ No. pcs
	H	W			
Blind rear panel IP65	1800	250	PPEB1825	1STQ007576A0000	1/1
Blind rear panel IP65	1800	500	PPEB1856	1STQ007579A0000	1/1
Blind rear panel IP65	1800	750	PPEB1875	1STQ007582A0000	1/1
Blind rear panel IP65	1800	1000	PPEB1816	1STQ007585A0000	1/1
Blind rear panel IP65	2000	250	PPEB2025	1STQ009380A0000	1/1
Blind rear panel IP65	2000	500	PPEB2056	1STQ008106A0000	1/1
Blind rear panel IP65	2000	750	PPEB2075	1STQ009400A0000	1/1
Blind rear panel IP65	2000	1000	PPEB2016	1STQ007596A0000	1/1

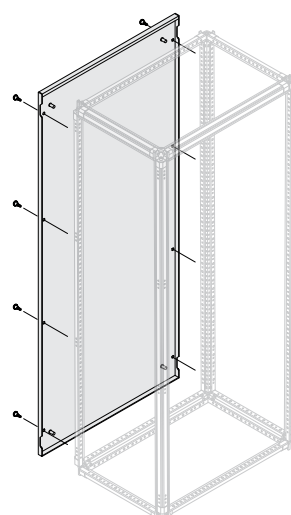

External blind rear panel IP30, IP40

Pickled sheet steel without gasket. In order to reach IPX1 protection degree it is necessary to add the proper top sealing kit PKPT..., page 4/12.

Description	Dimensions (mm)		Order code	ABB code	Package/ No. pcs
	H	W			
Blind rear panel IP30, IP40	1800	250	PPEB1827	1STQ009375A0000	1/1
Blind rear panel IP30, IP40	1800	500	PPEB1850	1STQ007610A0000	1/1
Blind rear panel IP30, IP40	1800	750	PPEB1877	1STQ009393A0000	1/1
Blind rear panel IP30, IP40	1800	1000	PPEB1810	1STQ007615A0000	1/1
Blind rear panel IP30, IP40	1800	right	PPRB1820	1STQ007616A0000	1/1
Blind rear panel IP30, IP40		left	PPLB1820	1STQ007617A0000	1/1
Blind rear panel IP30, IP40	2000	250	PPEB2027	1STQ009381A0000	1/1
Blind rear panel IP30, IP40	2000	500	PPEB2050	1STQ007621A0000	1/1
Blind rear panel IP30, IP40	2000	750	PPEB2077	1STQ009401A0000	1/1
Blind rear panel IP30, IP40	2000	1000	PPEB2010	1STQ007626A0000	1/1
Blind rear panel IP30, IP40	2000	right	PPRB2020	1STQ007627A0000	1/1
Blind rear panel IP30, IP40		left	PPLB2020	1STQ007628A0000	1/1

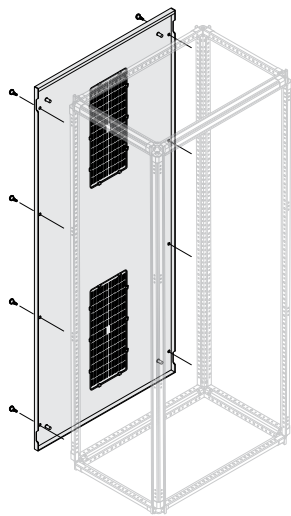

External vented rear panel IP30

In order to reach IPX1 protection degree it is necessary to add the proper top sealing kit PKPT...., page 4/12.

Description	No. Vented grates	Dimensions (mm)		Order code	ABB code	Package/ No. pcs
		H	W			
Vented rear panel IP30	2	1800	750	PPEA1875	1STQ007635A0000	1/1
Vented rear panel IP30/31 with gasket	right	1800	1250	PPRA1820	1STQ007639A0000	1/1
	left			PPLA1820	1STQ007640A0000	1/1
Vented rear panel IP30	2	2000	750	PPEA2075	1STQ009919A0000	1/1
Vented rear panel IP30 with gasket	right	2000	1250	PPRA2020	1STQ007649A0000	1/1
	left			PPLA2020	1STQ007650A0000	1/1

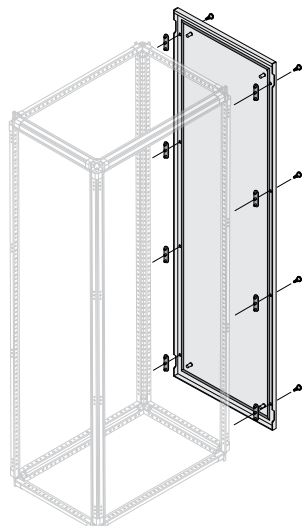

External blind side panel IP65

Pickled sheet steel with gasket and plugs IP65. The code refers to one single side panel.

Description	Dimensions (mm)		Order code	ABB code	Package/ No. pcs
	H	D			
Blind side panel IP65	1800	200	PPEB1826	1STQ007575A0000	1/1
Blind side panel IP65	1800	300	PPEB1836	1STQ007577A0000	1/1
Blind side panel IP65	1800	500	PPEB1856	1STQ007579A0000	1/1
Blind side panel IP65	1800	700	PPEB1876	1STQ007581A0000	1/1
Blind side panel IP65	1800	900	PPEB1896	1STQ007584A0000	1/1
Blind side panel IP65	2000	200	PPEB2026	1STQ007588A0000	1/1
Blind side panel IP65	2000	300	PPEB2036	1STQ007589A0000	1/1
Blind side panel IP65	2000	500	PPEB2056	1STQ008106A0000	1/1
Blind side panel IP65	2000	700	PPEB2076	1STQ008107A0000	1/1
Blind side panel IP65	2000	900	PPEB2096	1STQ008108A0000	1/1

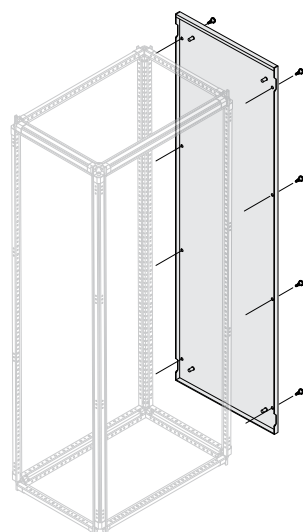

External blind side panel IP30, IP40

Pickled sheet steel with gasket. The code refers to one single side panel. In order to reach IPX1 protection degree it is necessary to add the proper top sealing kit PKPT...., page 4/12.

Description	Dimensions (mm)		Order code	ABB code	Package/ No. pcs
	H	D			
Blind side panel IP30, IP40	1800	200	PPEB1820	1STQ007607A0000	1/1
Blind side panel IP30, IP40	1800	300	PPEB1830	1STQ007608A0000	1/1
Blind side panel IP30, IP40	1800	500	PPEB1850	1STQ007610A0000	1/1
Blind side panel IP30, IP40	1800	700	PPEB1870	1STQ007612A0000	1/1
Blind side panel IP30, IP40	1800	900	PPEB1890	1STQ007614A0000	1/1
Blind side panel IP30, IP40	2000	200	PPEB2020	1STQ007618A0000	1/1
Blind side panel IP30, IP40	2000	300	PPEB2030	1STQ007619A0000	1/1
Blind side panel IP30, IP40	2000	500	PPEB2050	1STQ007621A0000	1/1
Blind side panel IP30, IP40	2000	700	PPEB2070	1STQ007623A0000	1/1
Blind side panel IP30, IP40	2000	900	PPEB2090	1STQ007625A0000	1/1

System pro E power

CombiLine-M - Order codes

4

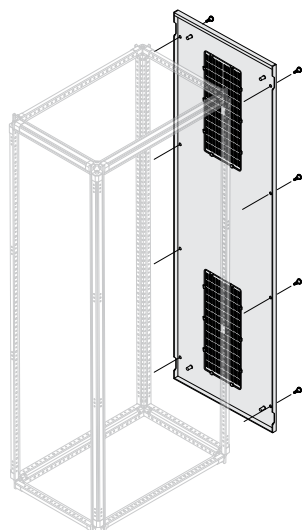

External vented side panel IP30

Pickled sheet steel without gasket. The code refers to one single side panel. In order to reach IPX1 protection degree it is necessary to add the proper top sealing kit PKPT...., page 4/12.

Description	No. Vented grates	Dimensions (mm)		Order code	ABB code	Package/ No. pcs
		H	D			
Vented side panel IP30	2	1800	300	PPEA1830	1STQ007630A0000	1/1
Vented side panel IP30	2	1800	500	PPEA1850	1STQ007632A0000	1/1
Vented side panel IP30	2	1800	700	PPEA1870	1STQ007634A0000	1/1
Vented side panel IP30	4	1800	900	PPEA1890	1STQ007637A0000	1/1
Vented side panel IP30	2	2000	300	PPEA2030	1STQ007641A0000	1/1
Vented side panel IP30	2	2000	500	PPEA2050	1STQ007643A0000	1/1
Vented side panel IP30	2	2000	700	PPEA2070	1STQ007645A0000	1/1
Vented side panel IP30	4	2000	900	PPEA2090	1STQ007647A0000	1/1

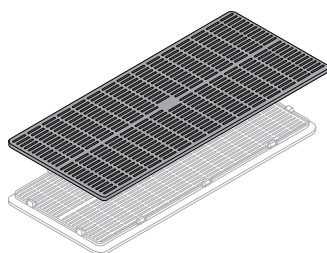

IP40 grate for Vented external panels

Accessory for Vented panels. Allows IP40 protection class to be obtained. Order the quantity on the basis of the number of grates on the panel. In order to reach IPX1 protection degree it is necessary to add the proper top sealing kit PKPT...., page 4/12.

Description	Order code	ABB code	Package/ No. pcs
No. IP40 grates for Vented panels	PGPP0040	1STQ008090A0000	1/2

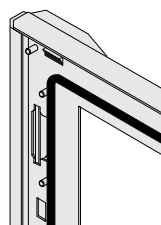

Glass door IP65

Pickled sheet steel with gasket. Opens through 135° (single column). Complete with 4 hinges to be screwed onto the uprights, 4 door closing brackets with cover and handle. Handle and hinges provided (not pre-assembled for complete reversibility). Doors can be mounted both on the front and on the back of the enclosures.

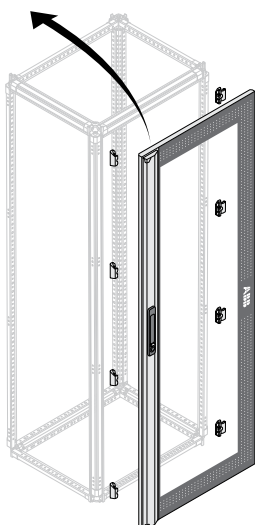

Description	Dimensions (mm)		Order code	ABB code	Package/ No. pcs
	H	W			
Glass door					
Glass door IP65	1800	500	PDLG1856	1STQ009414A0000	1/1
Glass door IP65	1800	750	PDLG1876	1STQ009396A0000	1/1
Glass door IP65	1800	1000	PDLG1816	1STQ007311A0000	1/1
Glass door IP65	2000	500	PDLG2056	1STQ009420A0000	1/1
Glass door IP65	2000	750	PDLG2066	1STQ007316A0000	1/1
Glass door IP65	2000	1000	PDLG2076	1STQ009404A0000	1/1

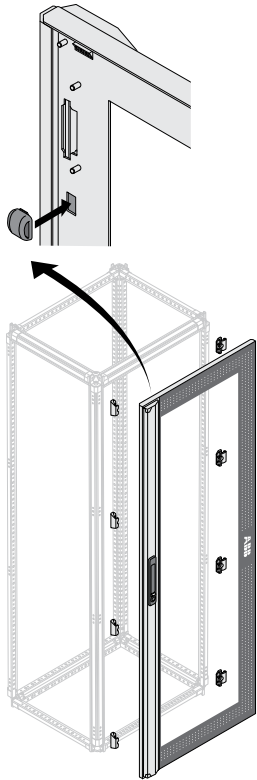

Glass door IP40

Pickled sheet steel without gasket and 4 rubber overlapping plugs. Opens through 135° (single column). Complete with 4 hinges to be screwed onto the uprights, 4 door closing brackets with cover and handle. Handle and hinges provided (not pre-assembled for complete reversibility). In order to reach IPX1 protection degree it is necessary to add the proper top sealing kit PKPT...., page 4/12. Doors can be mounted both on the front and on the back of the enclosures.

Description	Dimensions (mm)		Order code	ABB code	Package/ No. pcs
	H	W			
Glass door					
Glass door IP40	1800	500	PDLG1850	1STQ009415A0000	1/1
Glass door IP40	1800	750	PDLG1870	1STQ009397A0000	1/1
Glass door IP40	1800	1000	PDLG1810	1STQ007333A0000	1/1
Glass door IP40	2000	500	PDLG2050	1STQ009421A0000	1/1
Glass door IP40	2000	750	PDLG2070	1STQ009405A0000	1/1
Glass door IP40	2000	1000	PDLG2010	1STQ007344A0000	1/1

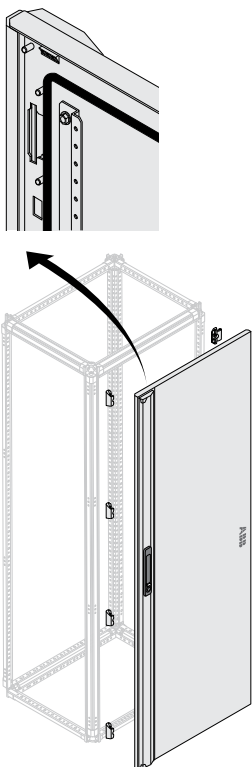

Blind door IP65

Pickled sheet steel with gasket. Opens through 135° (single column). Complete with 4 hinges to be screwed onto the uprights, 4 door closing brackets with cover and handle. Handle and hinges provided (not pre-assembled for complete reversibility). Doors can be mounted both on the front and on the back of the enclosures. Reinforcing tubes for W>400mm

Description	Dimensions (mm)		Order code	ABB code	Package/ No. pcs
	H	W			
Blind door IP65	1800	250	PDLB1826	1STQ009376A0000	1/1
Blind door IP65	1800	500	PDLB1856	1STQ009412A0000	1/1
Blind door IP65	1800	750	PDLB1876	1STQ009427A0000	1/1
Blind door IP65	1800	1000	PDLB1816	1STQ007351A0000	1/1
Blind door IP65	2000	250	PDLB2026	1STQ009382A0000	1/1
Blind door IP65	2000	500	PDLB2056	1STQ009418A0000	1/1
Blind door IP65	2000	750	PDLB2076	1STQ009402A0000	1/1
Blind door IP65	2000	1000	PDLB2016	1STQ007358A0000	1/1

System pro E power

CombiLine-M - Order codes

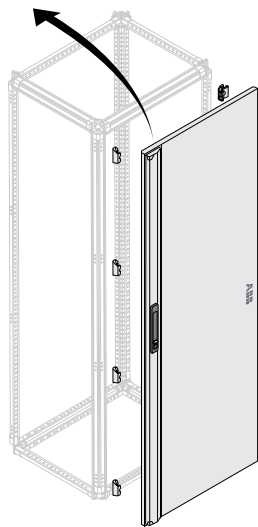
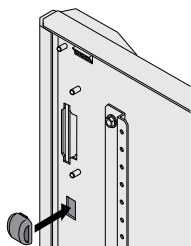

4

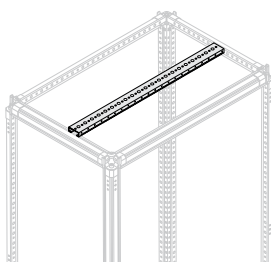
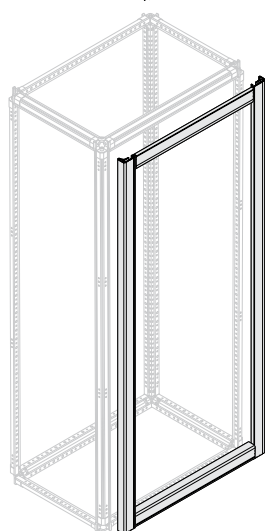

Blind door IP40

Pickled sheet steel without gasket and 4 rubber overlapping plugs. Opens through 135° (single column). Complete with 4 hinges to be screwed onto the uprights, 4 door closing brackets with cover and handle. Handle and hinges provided (not pre-assembled for complete reversibility). In order to reach IPX1 protection degree it is necessary to add the proper top sealing kit PKPT..., page 4/12. Doors can be mounted both on the front and on the back of the enclosures. Reinforcing tubes for W>400mm

Description	Dimensions (mm)		Order code	ABB code	Package/ No. pcs
	H	W			
Blind door IP40/IP41	1800	250	PDLB1825	1STQ009377A0000	1/1
Blind door IP40/IP41	1800	500	PDLB1850	1STQ009413A0000	1/1
Blind door IP40/IP41	1800	750	PDLB1875	1STQ009395A0000	1/1
Blind door IP40/IP41	1800	1000	PDLB1810	1STQ007365A0000	1/1
Blind door IP40/IP41	2000	250	PDLB2025	1STQ009383A0000	1/1
Blind door IP40/IP41	2000	500	PDLB2050	1STQ009419A0000	1/1
Blind door IP40/IP41	2000	750	PDLB2075	1STQ009403A0000	1/1
Blind door IP40/IP41	2000	1000	PDLB2010	1STQ007372A0000	1/1

Horizontal/vertical front closing profiles IP30

Profiles for IP30/IP31 pickled sheet painted RAL 7035. In order to reach IPX1 protection degree it is necessary to add the proper top sealing kit PKPT..., page 4/12.

Description	Dimensions (mm)		Order code	ABB code	Package/ No. pcs
	H	W			
Finishing profiles vertical structure and external cable compartment					
No.2 vertical profiles IP30	1800		PPFV1800	1STQ008059A0000	1/2
No.2 vertical profiles IP30	2000		PPFV2000	1STQ008060A0000	1/2
Finishing profile vertical internal cable compartment					
No.1 profile vertical IP30	1800		PPCV1800	1STQ009294A0000	1/1
No.1 profile vertical IP30	2000		PPCV2000	1STQ009295A0000	1/1
Finishing profiles horizontal structure and external cable compartment					
No.2 horizontal profiles IP30		250	PPFH0250	1STQ009378A0000	1/2
No.2 horizontal profiles IP30		500	PPFH0500	1STQ009416A0000	1/2
No.2 horizontal profiles IP30		750	PPFH0750	1STQ009398A0000	1/2
No.2 horizontal profiles IP30		1000	PPFH1000	1STQ008057A0000	1/2
No.2 horizontal profiles IP30		1250	PPFH1250	1STQ008058A0000	1/2

Crosspiece for horizontal busbar assembly under top or on bottom of structure

For assembly in D>300mm structures with internal cable compartment, order PCCM.... cable compartment depth.

Description	Dimensions W (mm)	Order code	ABB code	Package/ No.pcs
Intermediate crosspiece for bus-bars under top/on bottom	250	PCKI0250	1STQ001328B0000	1/1
Intermediate crosspiece for bus-bars under top/on bottom	500	PCIS0500	1STQ009165A0000	1/1
Intermediate crosspiece for bus-bars under top/on bottom	750	PCKI0750	1STQ001330B0000	1/1
Intermediate crosspiece for bus-bars under top/on bottom	1000	PCKI1000	1STQ008103A0000	1/1
Intermediate crosspiece for bus-bars under top/on bottom	1250	PCKI1250	1STQ008104A0000	1/1

Configuration example

Functional dimensions 2000x750x500mm (HxWxD) structure with H=100mm plinth, adapted to CombiLine-M fixing. WR frame and CombiLine-M modules to be added.

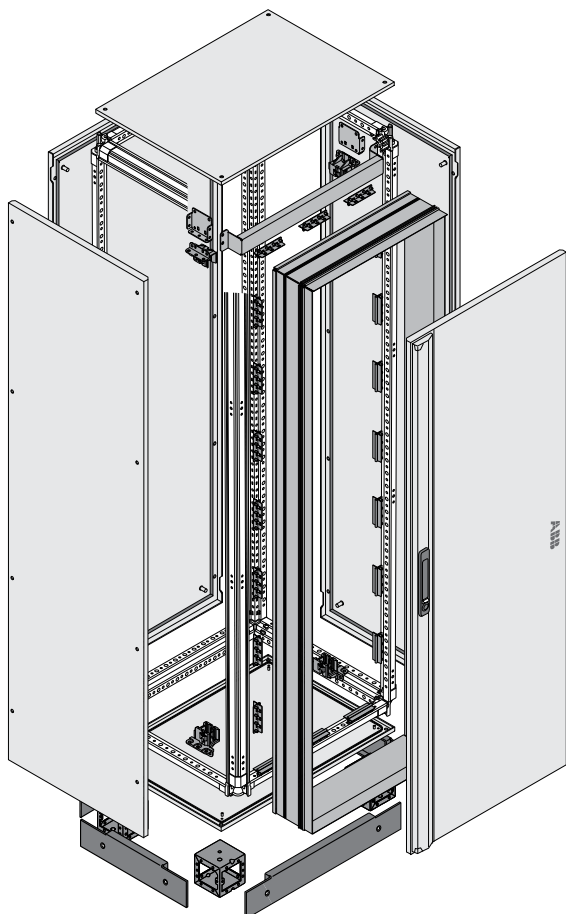

Quantity	Order code	Part	Description
1	PJPM2000	Structure	No. 4 galvanized sheet uprights H=2000mm
1	PCFM0750	Structure	No. 4 width stainless steel crosspieces W=750mm
1	PCFM0500	Structure	No. 4 depth galvanized sheet crosspieces D=500mm
1	PPAM0100	Structure	No. 4 corners plinth H=100mm
1	PPFM1075	Structure	No. 2 front/rear plinth flanges W=750mm
1	PPFM1050	Structure	No. 2 side plinth flanges D=500mm
2	PTBB7550	External covers	IP30/31, 40/41 blind top/bottom W=750mm D=500mm
1	PPEB2077	External covers	IP30/31, IP40/41 blind back panel H=2000mm W=750mm
2	PPEB2050	External covers	IP30/IP31, IP40/IP41 blind side panel H=2000mm D=500mm
1	PDLB2075	External covers	IP40/IP41 blind door H=2000mm W=750mm
1	PCTG2075	CombiLine-M adaptors	Touch Guard profile H2000 W750
1	PBCM0004	CombiLine-M adaptors	CombiLine-M fixing set
1	PCCM2075	CombiLine-M adaptors	CombiLine-M adapter H=2000 W=750

System pro E power

InLine II - General information

Introduction

The latest technology of Fuse Switch Disconnectors. The new generation InLine II ensures the best stability and the highest safety in the power distribution network during operation and service.

Feature		InLine II ZLBM/ZHBM
Rated operational voltage U_e	[M]	400 / 500 / 690
Rated operational current I_e	[A]	125...630

4



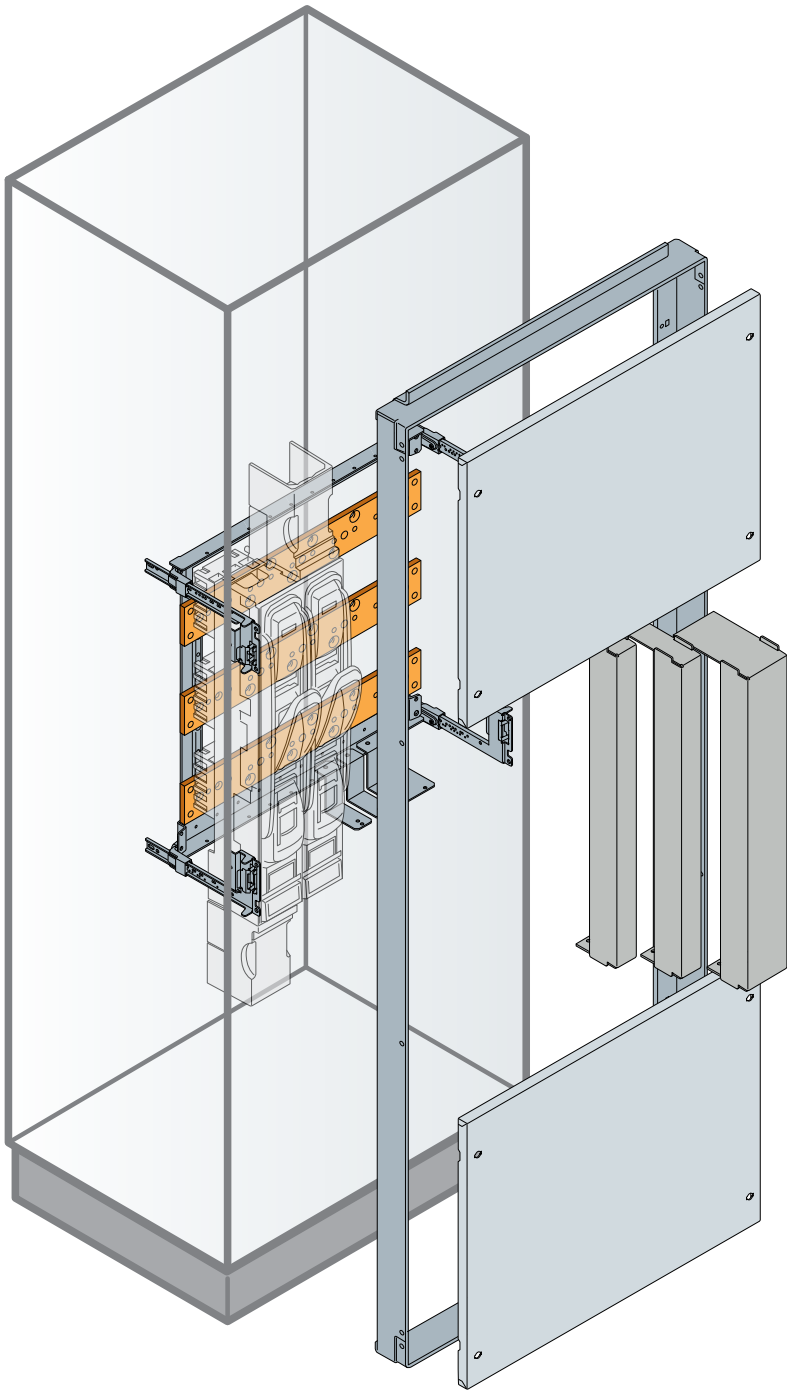

System pro E power

InLine II - Quick selection guide

Recommended installation solutions

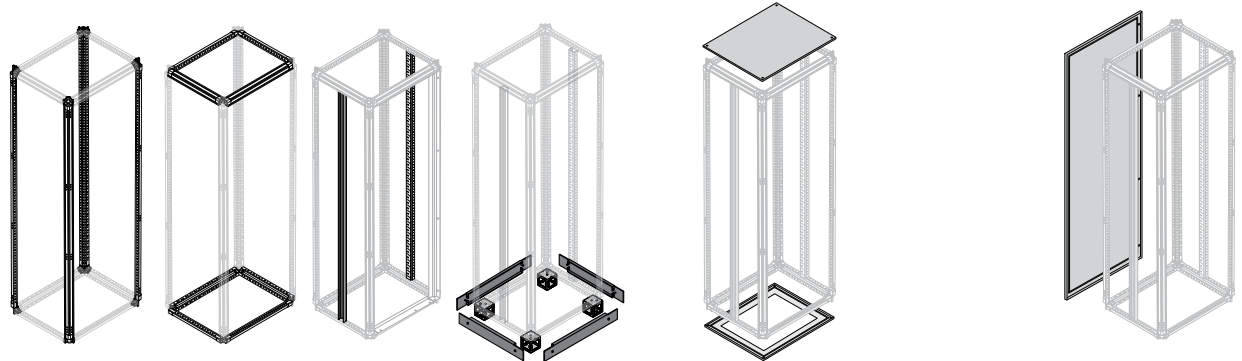

H=1800mm

Functional dimensions		External dimensions		FRAME						EXTERNAL COVERS										
Height 1800mm	W (mm)	D (mm)	Height 1913mm	W (mm)	D (mm)	Uprights Galvanized sheet metal * In<4000A	Structure crosspieces		H=100mm plinth		Top/bottom panels				Front/rear/side panels					
							Front/ Rear	Sides	Angle pieces	Front/ Rear	Sides	Top/Bottom		Bottom Without plinth		Rear panel				
						Galvanized sheet metal * In<4000A		Intermediate upright	Galvanized sheet metal In<4000A *	Plinth flanges	Blind	IP30 ⁽¹⁾ IP40 ⁽¹⁾	Open ⁽²⁾ IP65	IP40 ⁽³⁾ IP65	IP65	IP30 ⁽¹⁾ IP40 ⁽¹⁾				
600	500	700	700	616	816	PUPM1800	PCFM0600	PCFM0700	PUKI1800	PPMA0100	PPFM1060	PPFM1070	PTBB6056	PTBB6050	PTB06050	PBWP2550	PPEB1866	PPEB1860		
	700	700		816									PCFM0900	PPFM1090	PTBB6076	PTBB6070			PTB06070	PBWP2570
	900	1016		PCFM0500									PPFM1050	PTBB8056	PTBB8050	PTB05050			PBWP5050	
800	500	700	900	616	816	PUPM1800	PCFM0800	PCFM0700	PUKI1800	PPMA0100	PPFM1060	PPFM1070	PTBB8076	PTBB8070	PTB05070	PBWP5070	PPEB1886	PPEB1880		
	700	900		816									PCFM0900	PPFM1090	PTBB8096	PTBB8090			PTB05090	PBWP5090
	900	1016		PCFM0500									PPFM1050	PTBB1056	PTBB1050	PTB01050			PBWP1050	
1000	500	700	1000	616	816	PUPM1800	PCFM1000	PCFM0700	PUKI1800	PPMA0100	PPFM1060	PPFM1070	PTBB1076	PTBB1070	PTB01070	PBWP1070	PPEB1816	PPEB1810		
	700	1000		816									PCFM0900	PPFM1090	PTBB1096	PTBB1090			PTB01090	PBWP1090
	900	1016		PCFM0500									PPFM1050	PTBB1056	PTBB1050	PTB01050			PBWP1050	

H=2000mm

Functional dimensions		External dimensions		FRAME						EXTERNAL COVERS										
Height 2000mm	W (mm)	D (mm)	Height 2013mm	W (mm)	D (mm)	Uprights Galvanized sheet metal * In<4000A	Structure crosspieces		H=100mm plinth		Top/bottom panels				Front/rear/side panels					
							Front/ Rear	Sides	Angle pieces	Front/ Rear	Sides	Top/Bottom		Bottom Without plinth		Rear panel				
						Galvanized sheet metal * In<4000A		Intermediate upright	Galvanized sheet metal In<4000A *	Plinth flanges	Blind	IP30 ⁽¹⁾ IP40 ⁽¹⁾	Open ⁽²⁾ IP65	IP40 ⁽³⁾ IP65	IP65	IP30 ⁽¹⁾ IP40 ⁽¹⁾				
600	500	700	700	616	816	PUPM2000	PCFM0600	PCFM0700	PUKI2000	PPMA0100	PPFM1060	PPFM1070	PTBB6056	PTBB6050	PTB06050	PBWP2550	PPEB2066	PPEB2060		
	700	700		816									PCFM0900	PPFM1090	PTBB6076	PTBB6070			PTB06070	PBWP2570
	900	1016		PCFM0500									PPFM1050	PTBB8056	PTBB8050	PTB05050			PBWP5050	
800	500	700	900	616	816	PUPM2000	PCFM0800	PCFM0700	PUKI2000	PPMA0100	PPFM1060	PPFM1070	PTBB8076	PTBB8070	PTB05070	PBWP5070	PPEB2086	PPEB2080		
	700	900		816									PCFM0900	PPFM1090	PTBB8096	PTBB8090			PTB05090	PBWP5090
	900	1016		PCFM0500									PPFM1050	PTBB1056	PTBB1050	PTB01050			PBWP1050	
1000	500	700	1100	616	816	PUPM2000	PCFM1000	PCFM0700	PUKI2000	PPMA0100	PPFM1060	PPFM1070	PTBB1076	PTBB1070	PTB01070	PBWP1070	PPEB2016	PPEB2010		
	700	1100		816									PCFM0900	PPFM1090	PTBB1096	PTBB1090			PTB01090	PBWP1090
	900	1016		PCFM0500									PPFM1050	PTBB1056	PTBB1050	PTB01050			PBWP1050	

* Also available in stainless steel, see page 2/8.

Consult page 2/12 and 7/2 for selection of the protection class.

⁽¹⁾ In order to reach IPX1 protection degree it is necessary to add the proper top sealing kit, page 2/23.

⁽²⁾ Use the dedicated incoming cable flanges to obtain protection class IP65.

⁽³⁾ Bottom for switchboard without plinth complete with the dedicated set of brackets, which can be ordered separately.

> Order codes page 4/24 > Technical details page 7/1 > Overall dimensions page 8/1

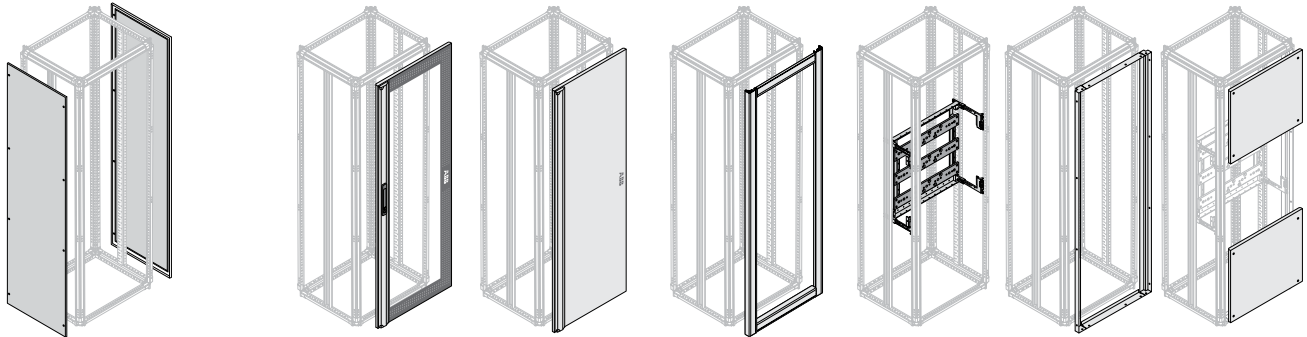

										INLINE II		
										Finishing profiles IP30		
Vented	Side panel			Glass door 24/36/48 mod. DIN		Blind door 24/36/48 mod. DIN		Vertical profile	Horizontal profile	InLine II kit	Fixed frame	Front panels
	Blind	IP30 ⁽¹⁾	IP40 ⁽¹⁾	IP65	IP40 ⁽¹⁾	IP65	IP40 ⁽¹⁾					
IP30 ⁽¹⁾	IP65	IP30 ⁽¹⁾	IP40 ⁽¹⁾	IP65	IP40 ⁽¹⁾	IP65	IP40 ⁽¹⁾					
PPEA1860	PPEB1856 PPEB1876 PPEB1896	PPEB1850 PPEB1870 PPEB1890	PPEA1850 PPEA1870 PPEA1890	PDLG1866	PDLG1860	PDLB1866	PDLB1860	PPFV1800	PPFH0600	PKNL1260	PFNL1860	No.2 PPNL3060
PPEA1880	PPEB1856 PPEB1876 PPEB1896	PPEB1850 PPEB1870 PPEB1890	PPEA1850 PPEA1870 PPEA1890	PDLG1886	PDLG1880	PDLB1886	PDLB1880	PPFV1800	PPFH0800	PKNL1280	PFNL1880	No.2 PPNL3080
PPEA1810	PPEB1856 PPEB1876 PPEB1896	PPEB1850 PPEB1870 PPEB1890	PPEA1850 PPEA1870 PPEA1890	PDLG1816	PDLG1810	PDLB1816	PDLB1810	PPFV1800	PPFH1000	PKNL1210	PFNL1810	No.2 PPNL3010

										INLINE II		
										Finishing profiles IP30		
Vented	Side panel			Glass door 24/36/48 mod. DIN		Blind door 24/36/48 mod. DIN		Vertical profile	Horizontal profile	InLine II kit	Fixed frame	Front panels
	Blind	IP30 ⁽¹⁾	IP40 ⁽¹⁾	IP65	IP40 ⁽¹⁾	IP65	IP40 ⁽¹⁾					
IP30 ⁽¹⁾	IP65	IP30 ⁽¹⁾	IP40 ⁽¹⁾	IP65	IP40 ⁽¹⁾	IP65	IP40 ⁽¹⁾					
PPEA2060	PPEB1856 PPEB1876 PPEB1896	PPEB1850 PPEB1870 PPEB1890	PPEA1850 PPEA1870 PPEA1890	PDLG2066	PDLG2060	PDLB2066	PDLB2060	PPFV2000	PPFH0600	PKNL1260	PFNL2060	No.2 PPNL4060
PPEA2080	PPEB1856 PPEB1876 PPEB1896	PPEB1850 PPEB1870 PPEB1890	PPEA1850 PPEA1870 PPEA1890	PDLG2086	PDLG2080	PDLB2086	PDLB2080	PPFV2000	PPFH0800	PKNL1280	PFNL2080	No.2 PPNL4080
PPEA2010	PPEB1856 PPEB1876 PPEB1896	PPEB1850 PPEB1870 PPEB1890	PPEA1850 PPEA1870 PPEA1890	PDLG2016	PDLG2010	PDLB2016	PDLB2010	PPFV2000	PPFH1000	PKNL1210	PFNL2010	No.2 PPNL4010

System pro E power

InLine II - Order codes

4

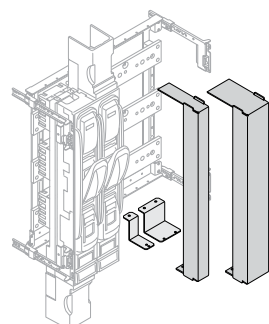
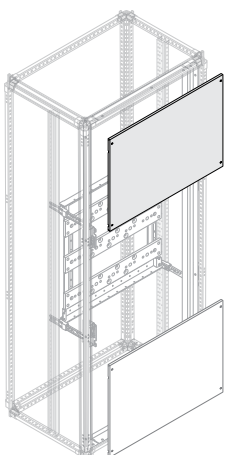
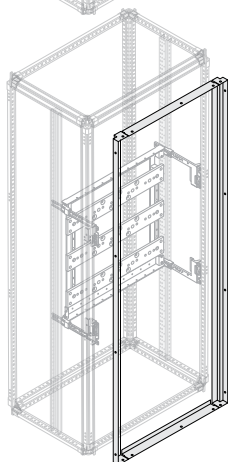
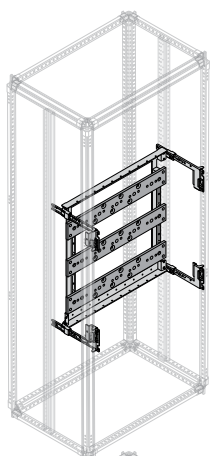

InLine II mounting kit

Kit for the fixing of InLine II fuseholders

Description	Dimensions (mm)		Order code	ABB code	Package/ No. pcs
	H	W			
InLine mounting kit + front panel	1200	600	PKNL1260	1STQ009823A0000	1/1
InLine mounting kit + front panel	1200	800	PKNL1280	1STQ009847A0000	1/1
InLine mounting kit + front panel	1200	1000	PKNL1210	1STQ009863A0000	1/1

Fixed frame for InLine II panels

Fixed frame for InLine II internal panels. InLine II fixed frame allows to fit only InLine II panels listed below.

Description	Dimensions (mm)		Order code	ABB code	Package/ No. pcs
	H	W			
Fixed frame for panels in the InLine column	1800	600	PFNL1860	1STQ001372B0000	1/1
Fixed frame for panels in the InLine column	1800	800	PFNL1880	1STQ001374B0000	1/1
Fixed frame for panels in the InLine column	1800	1000	PFNL1810	1STQ001376B0000	1/1
Fixed frame for panels in the InLine column	2000	600	PFNL2060	1STQ001373B0000	1/1
Fixed frame for panels in the InLine column	2000	800	PFNL2080	1STQ001375B0000	1/1
Fixed frame for panels in the InLine column	2000	1000	PFNL2010	1STQ001377B0000	1/1

Flat blind panels for InLine II fixed frame

Panels with 1/4 turn screws, hinged on the right or left with the dedicated PHFP0020 kit. These panels are dedicated to InLine II fixed frame only.

Description	Dimensions (mm)		Order code	ABB code	Package/ No. pcs
	H	W			
Blind flat panel for InLine column	300	600	PPNL3060	1STQ001378B0000	1/1
Blind flat panel for InLine column	300	800	PPNL3080	1STQ001379B0000	1/1
Blind flat panel for InLine column	300	1000	PPNL3010	1STQ001380B0000	1/1
Blind flat panel for InLine column	400	600	PPNL4060	1STQ001381B0000	1/1
Blind flat panel for InLine column	400	800	PPNL4080	1STQ001382B0000	1/1
Blind flat panel for InLine column	400	1000	PPNL4010	1STQ001383B0000	1/1

Order 2 pieces for a complete structure.

InLine II dummy modules

Dummy InLine II to cover free space in the enclosure and guarantee touch protection.

Description	Dimensions (mm)		Order code	ABB code	Package/ No. pcs
	W	H			
InLine vertical compensator	50		PCNL0050	1STQ009406A0000	1/1
InLine vertical compensator	100		PCNL0100	1STQ009368A0000	1/1

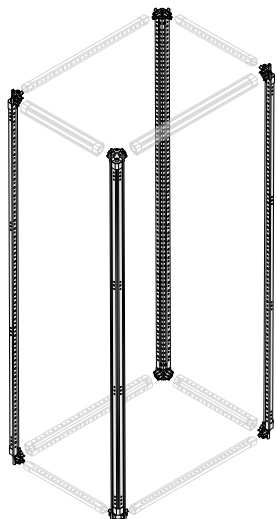

Uprights – Galvanized sheet metal *

Upright formed by a closed profile made of galvanized sheet metal. The uprights include 8 already assembled 3-way joints, 8 already assembled axial screws and 16 loose axial screws. For applications with $I_n \leq 4000A$.

Description	Dimensions H (mm)	Order code	Codice ABB	Package/ No. pcs
No.4 galvanized sheet metal uprights	1800	PUPM1800	1STQ007033A0000	1/4
No.4 galvanized sheet metal uprights	2000	PUPM2000	1STQ007034A0000	1/4

* Also available in stainless steel, see page 2/15.

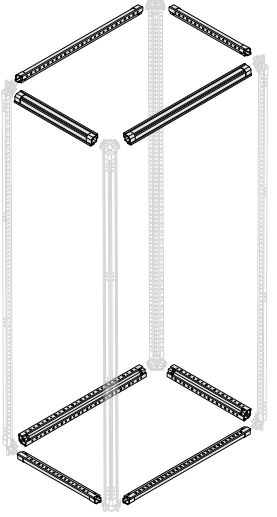

Structure crosspieces – Galvanized sheet metal *

Depth and width crosspieces for structures in galvanized sheet metal. For applications with $\leq 4000A$.

Description	Dimensions (mm)		Order code	ABB code	Package/ No. pcs
	W	D			
Width crosspieces					
No.4 width crosspieces galvanized sheet metal	600		PCFM0600	1STQ007040A0000	1/4
No.4 width crosspieces galvanized sheet metal	800		PCFM0800	1STQ007042A0000	1/4
No.4 width crosspieces galvanized sheet metal	1000		PCFM1000	1STQ007043A0000	1/4
Depth crosspieces					
No.4 width crosspieces galvanized sheet metal		500	PCFM0500	1STQ007039A0000	1/4
No.4 width crosspieces galvanized sheet metal		700	PCFM0700	1STQ007046A0000	1/4
No.4 width crosspieces galvanized sheet metal		900	PCFM0900	1STQ007047A0000	1/4

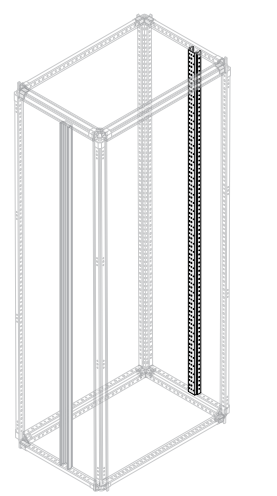

Intermediate upright for internal kit assembly

Intermediate depth upright for assembling kits for Tmax and Emax 2. The intermediate uprights are not required for assembling fixed Tmax XT1, XT2, XT3, XT4, T4, T5, T6 and XT1, XT3 with Direct Rotary Handle only in non-segregated structures. Order 2 uprights for the kits.

Description	Dimensions (mm) H	Order code	ABB code	Package/ No. pcs
Intermediate upright for internal kits	1800	PUKI1800	1STQ008039A0000	1/1
Intermediate upright for internal kits	2000	PUKI2000	1STQ008040A0000	1/1

System pro E power

InLine II - Order codes

PPAM0100

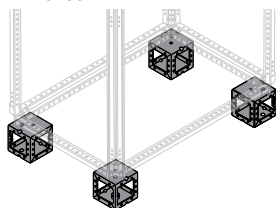

PPAM0200

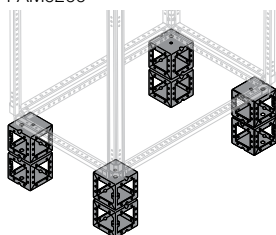

Universal angle pieces for plinths in galvanized sheet metal

Not pre-assembled to the structure. New angle piece with high mechanical strength. Can be fixed from the outside and from the inside of the structure even at a later date. Equipped with anti-rotation system and bottom that can be transported with a transpallet.

Description	Dimensions H (mm)	Order code	ABB code	Package/ No. pcs
No.4 plinth angle pieces	100	PPAM0100	1STQ007048A0000	1/4
No.8 plinth angle pieces H=100mm pre-assembled*	200	PPAM0200	1STQ007207A0000	1/4

*Order no. 2 pieces of H=100mm covering flange kits to complete the H=200mm plinth.

4

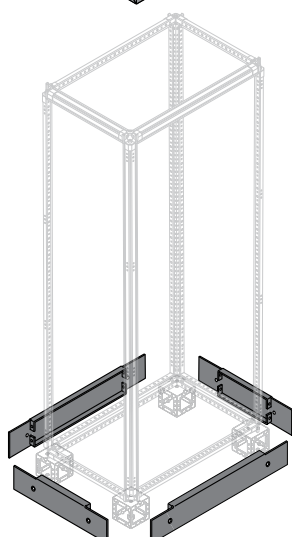

Plinth flanges

Side and front/rear plinth flanges H=100mm RAL 7012.

Description	Dimensions (mm)		Order code	ABB code	Package/ No. pcs
	W	D			
Front/rear plinth flanges					
No.2 plinth flanges	600		PPFM1060	1STQ007053A0000	1/2
No.2 plinth flanges	800		PPFM1080	1STQ007055A0000	1/2
No.2 plinth flanges	1000		PPFM1010	1STQ007056A0000	1/2
Side plinth flanges					
No.2 plinth flanges		500	PPFM1050	1STQ007052A0000	1/2
No.2 plinth flanges		700	PPFM1070	1STQ007059A0000	1/2
No.2 plinth flanges		900	PPFM1090	1STQ007060A0000	1/2

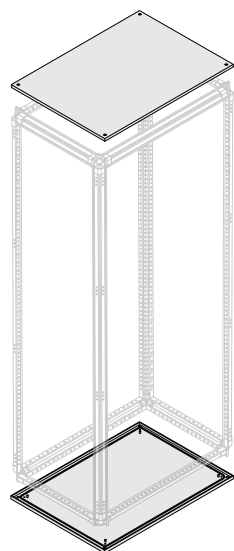

Blind Top/Bottom IP65 – Pickled sheet steel

Pickled sheet steel with IP65 gasket. The article comprises one single component that can be used as either a top or bottom. In order to purchase both the top and the bottom, please order two quantities of the same code or two different top/bottom codes according to the desired design of the structure. The code includes four M12x20 screws.

Description	Dimensions (mm)		Order code	ABB code	Package/ No. pcs
	W	D			
Blind Top/Bottom IP65	600	500	PTBB6056	1STQ007088A0000	1/1
Blind Top/Bottom IP65	600	700	PTBB6076	1STQ007089A0000	1/1
Blind Top/Bottom IP65	600	900	PTBB6096	1STQ007090A0000	1/1
Blind Top/Bottom IP65	800	500	PTBB8056	1STQ007096A0000	1/1
Blind Top/Bottom IP65	800	700	PTBB8076	1STQ007097A0000	1/1
Blind Top/Bottom IP65	800	900	PTBB8096	1STQ007098A0000	1/1
Blind Top/Bottom IP65	1000	500	PTBB1056	1STQ007100A0000	1/1
Blind Top/Bottom IP65	1000	700	PTBB1076	1STQ007101A0000	1/1
Blind Top/Bottom IP65	1000	900	PTBB1096	1STQ007102A0000	1/1

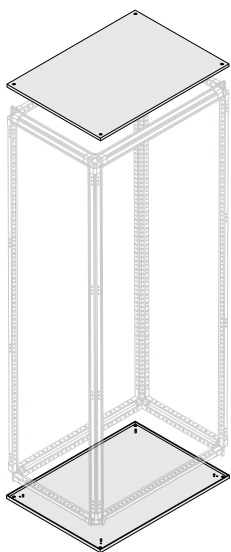

Blind Top/Bottom IP30, IP40 – Pickled sheet steel

Pickled sheet steel without gasket. In order to reach IPX1 protection degree it is necessary to add the proper top sealing kit, page 4/27.

The article comprises one single component that can be used as either a top or bottom. In order to purchase both the top and the bottom, please order two quantities of the same code or two different top/bottom codes according to the desired design of the structure. The code includes four M12x20 screws.

Description	Dimensions (mm)		Order code	ABB code	Package/ No. pcs
	W	D			
Blind Top/Bottom IP30, 40	600	500	PTBB6050	1STQ007119A0000	1/1
Blind Top/Bottom IP30, 40	600	700	PTBB6070	1STQ007120A0000	1/1
Blind Top/Bottom IP30, 40	600	900	PTBB6090	1STQ007121A0000	1/1
Blind Top/Bottom IP30, 40	800	500	PTBB8050	1STQ007124A0000	1/1
Blind Top/Bottom IP30, 40	800	700	PTBB8070	1STQ007125A0000	1/1
Blind Top/Bottom IP30, 40	800	900	PTBB8090	1STQ007126A0000	1/1
Blind Top/Bottom IP30, 40	1000	500	PTBB1050	1STQ007128A0000	1/1
Blind Top/Bottom IP30, 40	1000	700	PTBB1070	1STQ007129A0000	1/1
Blind Top/Bottom IP30, 40	1000	900	PTBB1090	1STQ007130A0000	1/1

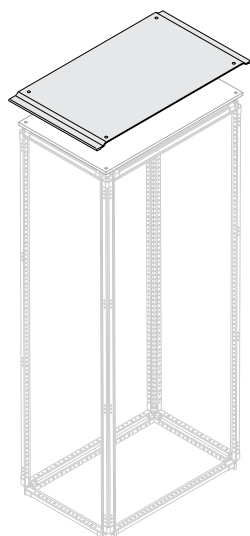

Top sealing kit IP31/IP41

Profiles for IP31/IP41 for top.

Description	Dimensions (mm)		Order code	ABB code	Package/ No. pcs
	W	D			
Top sealing kit IP31/IP41	600	500	PKPT6050	1STQ008073A0000	1/1
Top sealing kit IP31/IP41	600	700	PKPT6070	1STQ008074A0000	1/1
Top sealing kit IP31/IP41	600	900	PKPT6090	1STQ008075A0000	1/1
Top sealing kit IP31/IP41	800	500	PKPT8050	1STQ008078A0000	1/1
Top sealing kit IP31/IP41	800	700	PKPT8070	1STQ008079A0000	1/1
Top sealing kit IP31/IP41	800	900	PKPT8090	1STQ008080A0000	1/1
Top sealing kit IP31/IP41	1000	500	PKPT1050	1STQ008082A0000	1/1
Top sealing kit IP31/IP41	1000	700	PKPT1070	1STQ008083A0000	1/1
Top sealing kit IP31/IP41	1000	900	PKPT1090	1STQ008084A0000	1/1

System pro E power

InLine II - Order codes

4

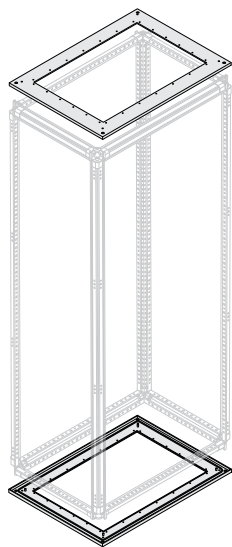

Open Top/Bottom

Pickled sheet steel with holes. The code comprises one single component that can be used as either a top or bottom. In order to purchase both the top and the bottom, please order two quantities of the same code or two different top/bottom codes according to the desired design of the structure.

In order to reach IP65 protection degree, use the dedicated fixed cable incoming flanges PFCF....; in order to reach IP40 protection degree, use the dedicated swinging cable incoming flanges PFCS.... at page 4/28-4/29.

The use of the single open top/bottom without flanges does not guarantee any degree of protection IP. The open top/bottom, associated with sliding flanges, is incompatible with crosspieces assembled inside the cable compartment.

Description	Dimensions (mm)		Order code	ABB code	Package/ No. pcs
	W	D			
Open Top/Bottom	600	500	PTBO6050	1STQ007149A0000	1/1
Open Top/Bottom	600	700	PTBO6070	1STQ007150A0000	1/1
Open Top/Bottom	600	900	PTBO6090	1STQ007151A0000	1/1
Open Top/Bottom	800	500	PTBO8050	1STQ007157A0000	1/1
Open Top/Bottom	800	700	PTBO8070	1STQ007158A0000	1/1
Open Top/Bottom	800	900	PTBO8090	1STQ007159A0000	1/1
Open Top/Bottom	1000	500	PTBO1050	1STQ007161A0000	1/1
Open Top/Bottom	1000	700	PTBO1070	1STQ007162A0000	1/1
Open Top/Bottom	1000	900	PTBO1090	1STQ007163A0000	1/1

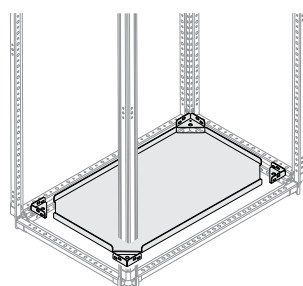

Internal bottom IP40

Internal galvanized steel bottom with special brackets kit included (special brackets kit available also as spare part with the code PBRB0004). In order to reach IPX1 protection degree it is necessary to add the proper top sealing kit PKPT..., page 4/27.

Description	Dimensions (mm)		Order code	ABB code	Package/ No. pcs
	W	D			
Internal bottom	600	500	PBWP6050	1STQ007185A0000	1/1
Internal bottom	600	700	PBWP6070	1STQ007186A0000	1/1
Internal bottom	600	900	PBWP6090	1STQ007187A0000	1/1
Internal bottom	800	500	PBWP8050	1STQ007193A0000	1/1
Internal bottom	800	700	PBWP8070	1STQ007194A0000	1/1
Internal bottom	800	900	PBWP8090	1STQ007195A0000	1/1
Internal bottom	1000	500	PBWP1050	1STQ007197A0000	1/1
Internal bottom	1000	700	PBWP1070	1STQ007198A0000	1/1
Internal bottom	1000	900	PBWP1090	1STQ007199A0000	1/1

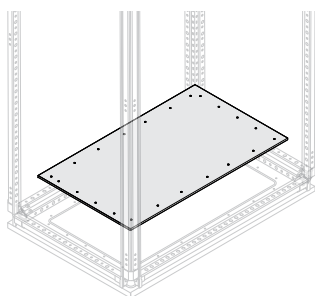

Fixed incoming cable flange

Fixed incoming cable flange in sheet metal to use in conjunction with the open bottom to guarantee IP65 protection class. With internal cable compartment crosspieces it is necessary to mount the fixed flange first.

Description	Dimensioni (mm)		Order code	ABB code	Package/ No. pcs
	W	D			
Fixed incoming cable flange	600	500	PFCF6050	1STQ007672A0000	1/1
Fixed incoming cable flange	600	700	PFCF6070	1STQ007673A0000	1/1
Fixed incoming cable flange	600	900	PFCF6090	1STQ007674A0000	1/1
Fixed incoming cable flange	800	500	PFCF8050	1STQ007680A0000	1/1
Fixed incoming cable flange	800	700	PFCF8070	1STQ007681A0000	1/1
Fixed incoming cable flange	800	900	PFCF8090	1STQ007682A0000	1/1
Fixed incoming cable flange	1000	500	PFCF1050	1STQ007684A0000	1/1
Fixed incoming cable flange	1000	700	PFCF1070	1STQ007685A0000	1/1
Fixed incoming cable flange	1000	900	PFCF1090	1STQ007686A0000	1/1

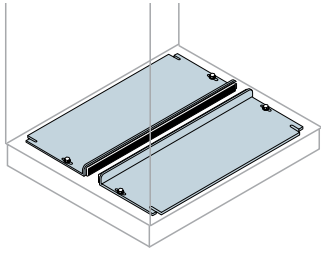

Sliding incoming cable flanges in sheet metal

Sliding incoming cable flanges in sheet metal to use in conjunction with the open bottom to guarantee IP40 protection class. It is not possible to assemble the sliding flanges in structures with internal cable compartment.

Description	Dimensioni (mm)		Order code	ABB code	Package/ No. pcs
	W	D			
No.2 sliding flanges	600	500	PFCS6050	1STQ007705A0000	1/2
No.2 sliding flanges	600	700	PFCS6070	1STQ007706A0000	1/2
No.2 sliding flanges	600	900	PFCS6090	1STQ007707A0000	1/2
No.2 sliding flanges	800	500	PFCS8050	1STQ007712A0000	1/2
No.2 sliding flanges	800	700	PFCS8070	1STQ007713A0000	1/2
No.2 sliding flanges	800	900	PFCS8090	1STQ007714A0000	1/2
No.2 sliding flanges	1000	500	PFCS1050	1STQ007716A0000	1/2
No.2 sliding flanges	1000	700	PFCS1070	1STQ007717A0000	1/2
No.2 sliding flanges	1000	900	PFCS1090	1STQ007718A0000	1/2

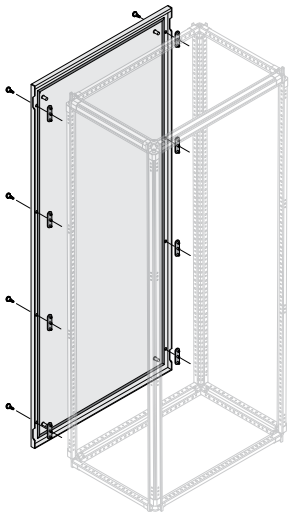

External blind rear panel IP65

Pickled sheet steel with gasket and plugs IP65.

Description	Dimensions (mm)		Order code	ABB code	Package/ No. pcs
	H	W			
Blind rear panel IP65	1800	600	PPEB1866	1STQ007580A0000	1/1
Blind rear panel IP65	1800	800	PPEB1886	1STQ007583A0000	1/1
Blind rear panel IP65	1800	1000	PPEB1816	1STQ007585A0000	1/1
Blind rear panel IP65	2000	600	PPEB2066	1STQ007592A0000	1/1
Blind rear panel IP65	2000	800	PPEB2086	1STQ007594A0000	1/1
Blind rear panel IP65	2000	1000	PPEB2016	1STQ007596A0000	1/1

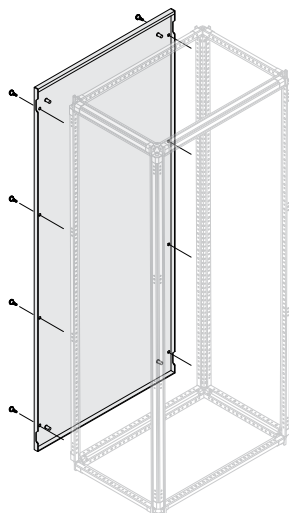

External blind rear panel IP30, IP40

Pickled sheet steel without gasket. In order to reach IPX1 protection degree it is necessary to add the proper top sealing kit PKPT..., page 4/27.

Description	Dimensions (mm)		Order code	ABB code	Package/ No. pcs
	H	W			
Blind rear panel IP30, IP40	1800	600	PPEB1860	1STQ007611A0000	1/1
Blind rear panel IP30, IP40	1800	800	PPEB1880	1STQ007613A0000	1/1
Blind rear panel IP30, IP40	1800	1000	PPEB1810	1STQ007615A0000	1/1
Blind rear panel IP30, IP40	2000	600	PPEB2060	1STQ007622A0000	1/1
Blind rear panel IP30, IP40	2000	800	PPEB2080	1STQ007624A0000	1/1
Blind rear panel IP30, IP40	2000	1000	PPEB2010	1STQ007626A0000	1/1

System pro E power

InLine II - Order codes

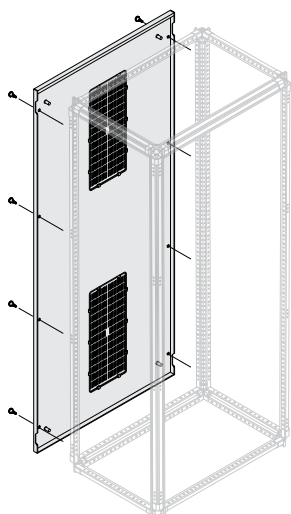

4

External vented rear panel IP30

In order to reach IPX1 protection degree it is necessary to add the proper top sealing kit PKPT....., page 4/27.

Description	No. Vented grates	Dimensions (mm)		Order code	ABB code	Package/ No. pcs
		H	W			
Vented rear panel IP30	2	1800	600	PPEA1860	1STQ007633A0000	1/1
Vented rear panel IP30	4	1800	800	PPEA1880	1STQ007636A0000	1/1
Vented rear panel IP30	6	1800	1000	PPEA1810	1STQ007638A0000	1/1
Vented rear panel IP30	2	2000	600	PPEA2060	1STQ007644A0000	1/1
Vented rear panel IP30	4	2000	800	PPEA2080	1STQ007646A0000	1/1
Vented rear panel IP30	6	2000	1000	PPEA2010	1STQ007648A0000	1/1

External blind side panel IP65

Pickled sheet steel with gasket and plugs IP65. The code refers to one single side panel.

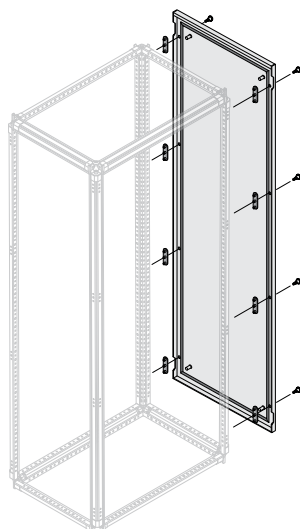

Description	Dimensions (mm)		Order code	ABB code	Package/ No. pcs
	H	D			
Blind side panel IP65	1800	500	PPEB1856	1STQ007579A0000	1/1
Blind side panel IP65	1800	700	PPEB1876	1STQ007581A0000	1/1
Blind side panel IP65	1800	900	PPEB1896	1STQ007584A0000	1/1
Blind side panel IP65	2000	500	PPEB2056	1STQ008106A0000	1/1
Blind side panel IP65	2000	700	PPEB2076	1STQ008107A0000	1/1
Blind side panel IP65	2000	900	PPEB2096	1STQ008108A0000	1/1

External blind side panel IP30, IP40

Pickled sheet steel with gasket. The code refers to one single side panel. In order to reach IPX1 protection degree it is necessary to add the proper top sealing kit PKPT....., page 4/27.

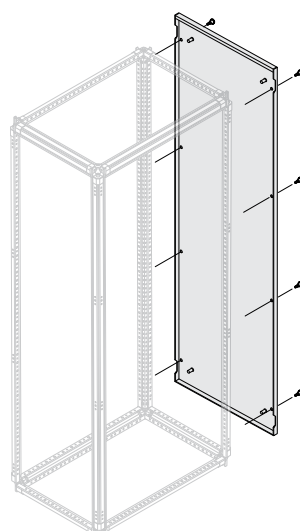

Description	Dimensions (mm)		Order code	ABB code	Package/ No. pcs
	H	D			
Blind side panel IP30, IP40	1800	500	PPEB1850	1STQ007610A0000	1/1
Blind side panel IP30, IP40	1800	700	PPEB1870	1STQ007612A0000	1/1
Blind side panel IP30, IP40	1800	900	PPEB1890	1STQ007614A0000	1/1
Blind side panel IP30, IP40	2000	500	PPEB2050	1STQ007621A0000	1/1
Blind side panel IP30, IP40	2000	700	PPEB2070	1STQ007623A0000	1/1
Blind side panel IP30, IP40	2000	900	PPEB2090	1STQ007625A0000	1/1

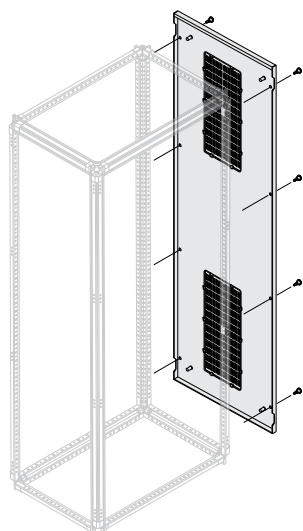

External vented side panel IP30

Pickled sheet steel without gasket. The code refers to one single side panel. In order to reach IPX1 protection degree it is necessary to add the proper top sealing kit PKPT...., page 4/27.

Description	No. Vented grates	Dimensions (mm)		Order code	ABB code	Package/ No. pcs
		H	D			
Vented side panel IP30	2	1800	500	PPEA1850	1STQ007632A0000	1/1
Vented side panel IP30	2	1800	700	PPEA1870	1STQ007634A0000	1/1
Vented side panel IP30	4	1800	900	PPEA1890	1STQ007637A0000	1/1
Vented side panel IP30	2	2000	500	PPEA2050	1STQ007643A0000	1/1
Vented side panel IP30	2	2000	700	PPEA2070	1STQ007645A0000	1/1
Vented side panel IP30	4	2000	900	PPEA2090	1STQ007647A0000	1/1

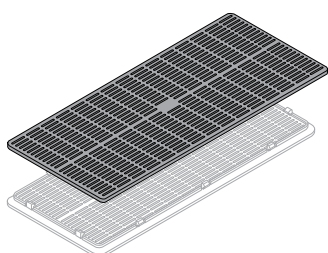

IP40 grate for Vented external panels

Accessory for Vented panels. Allows IP40 protection class to be obtained. Order the quantity on the basis of the number of grates on the panel. In order to reach IPX1 protection degree it is necessary to add the proper top sealing kit PKPT...., page 4/27.

Description	Order code	ABB code	Package/ No. pcs
No. IP40 grates for Vented panels	PGPP0040	1STQ008090A0000	1/2

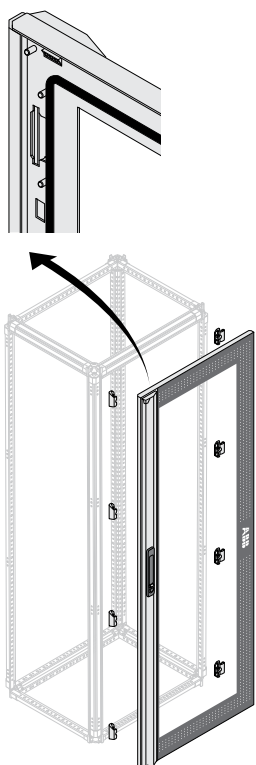

Glass door IP65

Pickled sheet steel with gasket. Opens through 135° (single column). Complete with 4 hinges to be screwed onto the uprights, 4 door closing brackets with cover and handle. Handle and hinges provided (not pre-assembled for complete reversibility). Doors can be mounted both on the front and on the back of the enclosures.

Description	No. DIN modules	Dimensions (mm)			Order code	ABB code	Package/ No. pcs
		H	W	Cable compartment W			
Glass door							
Glass door IP65	24	1800	600		PDLG1866	1STQ007305A0000	1/1
Glass door IP65	36	1800	800		PDLG1886	1STQ007308A0000	1/1
Glass door IP65	48	1800	1000		PDLG1816	1STQ007311A0000	1/1
Glass door IP65	24	2000	600		PDLG2066	1STQ007316A0000	1/1
Glass door IP65	36	2000	800		PDLG2086	1STQ007319A0000	1/1
Glass door IP65	48	2000	1000		PDLG2016	1STQ007322A0000	1/1

System pro E power

InLine II - Order codes

4

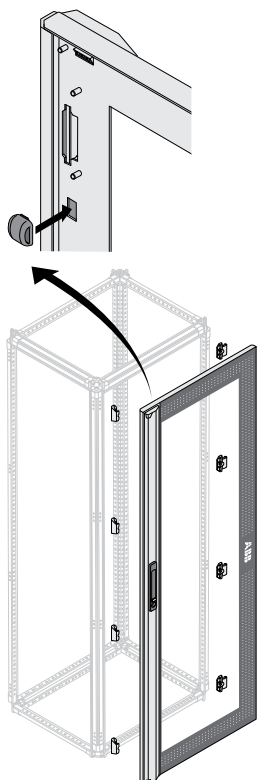

Glass door IP40

Pickled sheet steel without gasket and 4 rubber overlapping plugs. Opens through 135° (single column). Complete with 4 hinges to be screwed onto the uprights, 4 door closing brackets with cover and handle. Handle and hinges provided (not pre-assembled for complete reversibility). In order to reach IPX1 protection degree it is necessary to add the proper top sealing kit PKPT..., page 4/27. Doors can be mounted both on the front and on the back of the enclosures

Description	No. DIN modules	Dimensions (mm)		Order code	ABB code	Package/ No. pcs
		H	W			
Glass door						
Glass door IP40	24	1800	600	PDLG1860	1STQ007327A0000	1/1
Glass door IP40	36	1800	800	PDLG1880	1STQ007330A0000	1/1
Glass door IP40	48	1800	1000	PDLG1810	1STQ007333A0000	1/1
Glass door IP40	24	2000	600	PDLG2060	1STQ007338A0000	1/1
Glass door IP40	36	2000	800	PDLG2080	1STQ007341A0000	1/1
Glass door IP40	48	2000	1000	PDLG2010	1STQ007344A0000	1/1

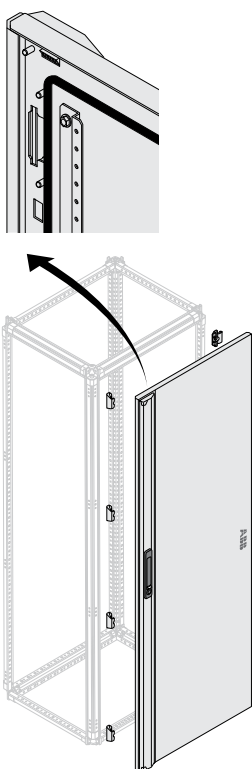

Blind door IP65

Pickled sheet steel with gasket. Opens through 135° (single column). Complete with 4 hinges to be screwed onto the uprights, 4 door closing brackets with cover and handle. Handle and hinges provided (not pre-assembled for complete reversibility). Doors can be mounted both on the front and on the back of the enclosures. Reinforcing tubes for W>400mm

Description	No. DIN modules	Dimensions (mm)		Order code	ABB code	Package/ No. pcs
		H	W			
Blind door IP65	24	1800	600	PDLB1866	1STQ007349A0000	1/1
Blind door IP65	36	1800	800	PDLB1886	1STQ007350A0000	1/1
Blind door IP65	48	1800	1000	PDLB1816	1STQ007351A0000	1/1
Blind door IP65	24	2000	600	PDLB2066	1STQ007356A0000	1/1
Blind door IP65	36	2000	800	PDLB2086	1STQ007357A0000	1/1
Blind door IP65	48	2000	1000	PDLB2016	1STQ007358A0000	1/1

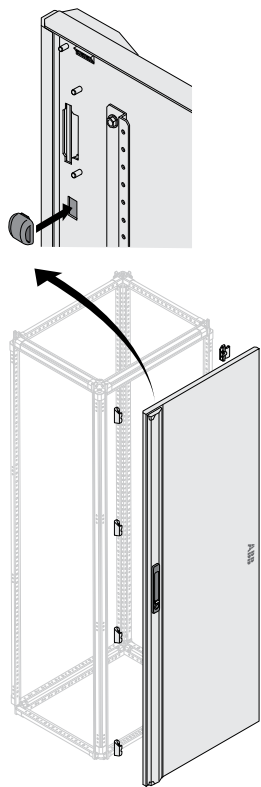

Blind door IP40/IP41

Pickled sheet steel without gasket and 4 rubber overlapping plugs. Opens through 135° (single column). Complete with 4 hinges to be screwed onto the uprights, 4 door closing brackets with cover and handle. Handle and hinges provided (not pre-assembled for complete reversibility). In order to reach IPX1 protection degree it is necessary to add the proper top sealing kit PKPT..., page 4/27. Doors can be mounted both on the front and on the back of the enclosures. Reinforcing tubes for W>400mm

Description	No. DIN modules	Dimensions (mm)		Order code	ABB code	Package/ No. pcs
		H	W			
Blind door IP40/IP41	24	1800	600	PDLB1860	1STQ007363A0000	1/1
Blind door IP40/IP41	36	1800	800	PDLB1880	1STQ007364A0000	1/1
Blind door IP40/IP41	48	1800	1000	PDLB1810	1STQ007365A0000	1/1
Blind door IP40/IP41	24	2000	600	PDLB2060	1STQ007370A0000	1/1
Blind door IP40/IP41	36	2000	800	PDLB2080	1STQ007371A0000	1/1
Blind door IP40/IP41	48	2000	1000	PDLB2010	1STQ007372A0000	1/1

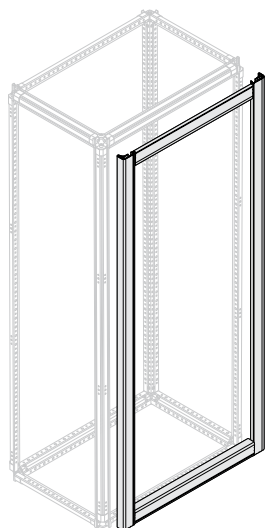

Horizontal/vertical front closing profiles IP30

Profiles for IP30/IP31 pickled sheet painted RAL 7035. In order to reach IPX1 protection degree it is necessary to add the proper top sealing kit PKPT..., page 4/27.

Description	Dimensions (mm)		Order code	ABB code	Package/ No. pcs
	H	W			
Finishing profiles vertical structure and external cable compartment					
No.2 vertical profiles IP30	1800		PPFV1800	1STQ008059A0000	1/2
No.2 vertical profiles IP30	2000		PPFV2000	1STQ008060A0000	1/2
Finishing profile vertical internal cable compartment					
No.1 profile vertical IP30	1800		PPCV1800	1STQ009294A0000	1/1
No.1 profile vertical IP30	2000		PPCV2000	1STQ009295A0000	1/1
Finishing profiles horizontal structure and external cable compartment					
No.2 horizontal profiles IP30		600	PPFH0600	1STQ008055A0000	1/2
No.2 horizontal profiles IP30		800	PPFH0800	1STQ008056A0000	1/2
No.2 horizontal profiles IP30		1000	PPFH1000	1STQ008057A0000	1/2

System pro E power

InLine II - Order codes

Configuration example

Functional dimensions 1800x800x700mm (HxWxD) structure with H=100mm plinth, InLine II kits and front panels covers.

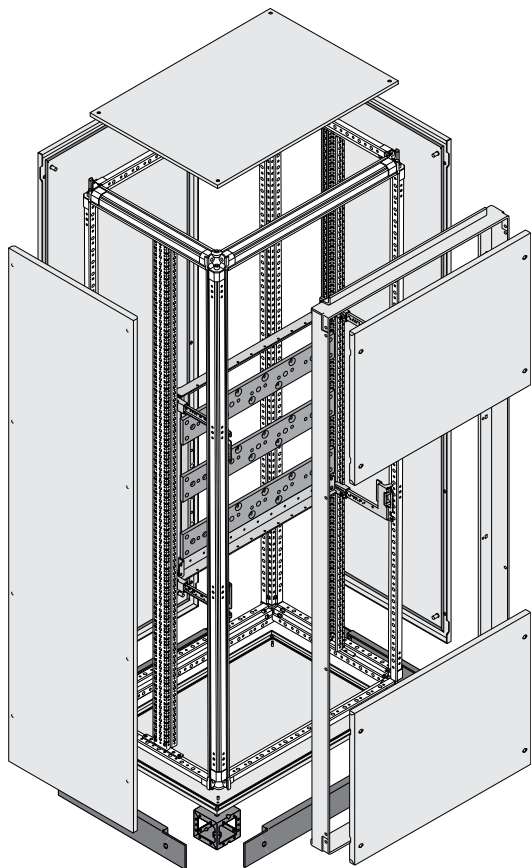

Quantity	Order code	Part	Description
1	PUPM1800	Structure	No. 4 galvanized sheet uprights H=1800mm
1	PCFM0800	Structure	No. 4 width galvanized sheet crosspieces W=800mm
1	PCFM0700	Structure	No. 4 depth galvanized sheet crosspieces D=700mm
1	PPAM0100	Structure	No. 4 corners plinth H=100mm
1	PPFM1080	Structure	No. 2 front/rear plinth flanges W=800mm
1	PPFM1070	Structure	No. 2 side plinth flanges D=700mm
2	PUKI2000	Kits	No. 1 Intermediate upright
1	PTBB8076	External covers	IP65 blind top/bottom W=800mm D=700mm
1	PPEB1886	External covers	IP65 blind back panel H=1800mm W=800mm
2	PPEB1876	External covers	IP65 blind side panel H=1800mm D=700mm
1	PDLG1886	External covers	IP65 36 DIN modules glass door H=1800mm W=800mm
1	PFNL1880	InLine II components	Fixed frame for panels in the InLine column H=1800mm W=800mm
2	PPNL3080	InLine II components	Blind flat panel for InLine column H=300mm W=800mm

System pro E power

Main distribution systems

General information	5/2
Selection guides	
Linear system	
Fixing busbar holders to the structure	5/6
Choice of busbar holders and closing crosspieces	5/8
Choice and assembly of the number of busbar holders	5/14
Scaled system	
Fixing busbar holders to the structure	5/16
Choice of busbar holders and closing crosspieces	5/17
Choice and assembly of the number of busbar holders	5/19
Compensators and connections for flat and shaped busbar	5/20
Flexible busbars up to 1250 A	5/22
Flat drilled and threaded busbars for earthing connection	5/22
Modular dividers	5/23
Guide to the order codes	5/25
Codes for ordering	
Main distribution systems	5/26
Accessories	5/36

System pro E power

General information

The distribution systems that can be used inside System pro E power switchboards meet the requirements of all applications, with 250A to 6300A configurations.

The new System pro E power distribution system has been designed for improved flexibility and simple busbar connections. Linear and scaled solutions are available and allow the busbars to be installed in any position: horizontally, under the top, on the bottom and at each height; vertically, along the side or at the rear and in the cable compartment. The structural components include:

- insulating support and tie rods
- crosspieces and brackets

The main advantages are:

- same construction philosophy for 250A to 6300A applications
- same multifunction insulating supports able to house flat busbars 5 and 10mm thick and shaped busbars ("click in" installation method for the linear version)
- the center distance between phases can be increased for the linear version by simply sliding the insulation support fastenings along the crosspieces
- same fixing crosspieces for both linear and scaled solutions
- stainless steel crosspieces for applications with $I_n \geq$ at 4000A to limit the effect of stray currents

The capacity of the busbars is as follows:

- flat copper busbars up to 6300A
- shaped profile busbars up to 2500A

Air and moulded-case circuit-breakers can be connected to the busbars by means of prefabricated rigid or flexible connections.

5



Number of busbars installable per insulator

	Linear System			Scaled System	
Flat busbars	1,2,3 or 4 bars per phase	50mm block	2000A	1 or 2 busbars per phase	2000A
		75mm block	3200A		
		100mm block	6300A		
Shaped busbars	1 per phase	50mm block	1600A	1 per phase	1600A
		75mm block	2000A		
		75mm block	2500A		

The crosspieces that fix to the structure are for universal use for both linear and scaled busbar holders.

The linear and scaled insulating supports house 5mm flat busbar systems on one side, while the other side houses shaped profile or 10mm section flat busbar systems.

One single tie rod in different lengths is used to fasten all types of busbars.



The linear busbar holder is formed by inserting, with a “click”, the insulating supports onto the crosspieces, which are fixed directly inside the switchboard by means of simple brackets.

LINEAR SYSTEM

The new busbar holder consists of:

- a polyamide insulating support (maximum operating temperature 130 °C) featuring shaped grooves for the busbars and pins for fixing to the crosspieces, able to house both flat and shaped profile busbars;
- crosspieces available in different lengths, made of hot-dip galvanized steel sheet for $I_n < 4000A$ current values or crosspieces in AISI 304 stainless steel for $I_n \geq 4000A$ current values.

The crosspiece is an integral part of the busbar holder and is fixed directly inside the cubicle with the purpose-made brackets. In addition, it can also be used as a universal crosspiece thanks to 5.5mm diameter round holes on the side and 10mm diameter holes for fixing the cage nuts.

Lastly, the crosspieces can be coupled on the external side to make the busbar system sturdier.

Since the insulating supports are modular, the center distance between the phases can be increased by spacing them at a 12.5mm pitch.

The tie rods that fix the insulating supports are made of thermoplastic material (for $I_n < 4000A$ current values). They are available in a single length of 195mm and can be adjusted to suit the busbars installed. The AISI 304 stainless steel tie rods (for $I_n \geq 4000A$ current values) are available for 120mm, 160mm and 200mm busbars.

The linear system can house flat busbars (5 and 10mm thick) and shaped profile busbars in copper.

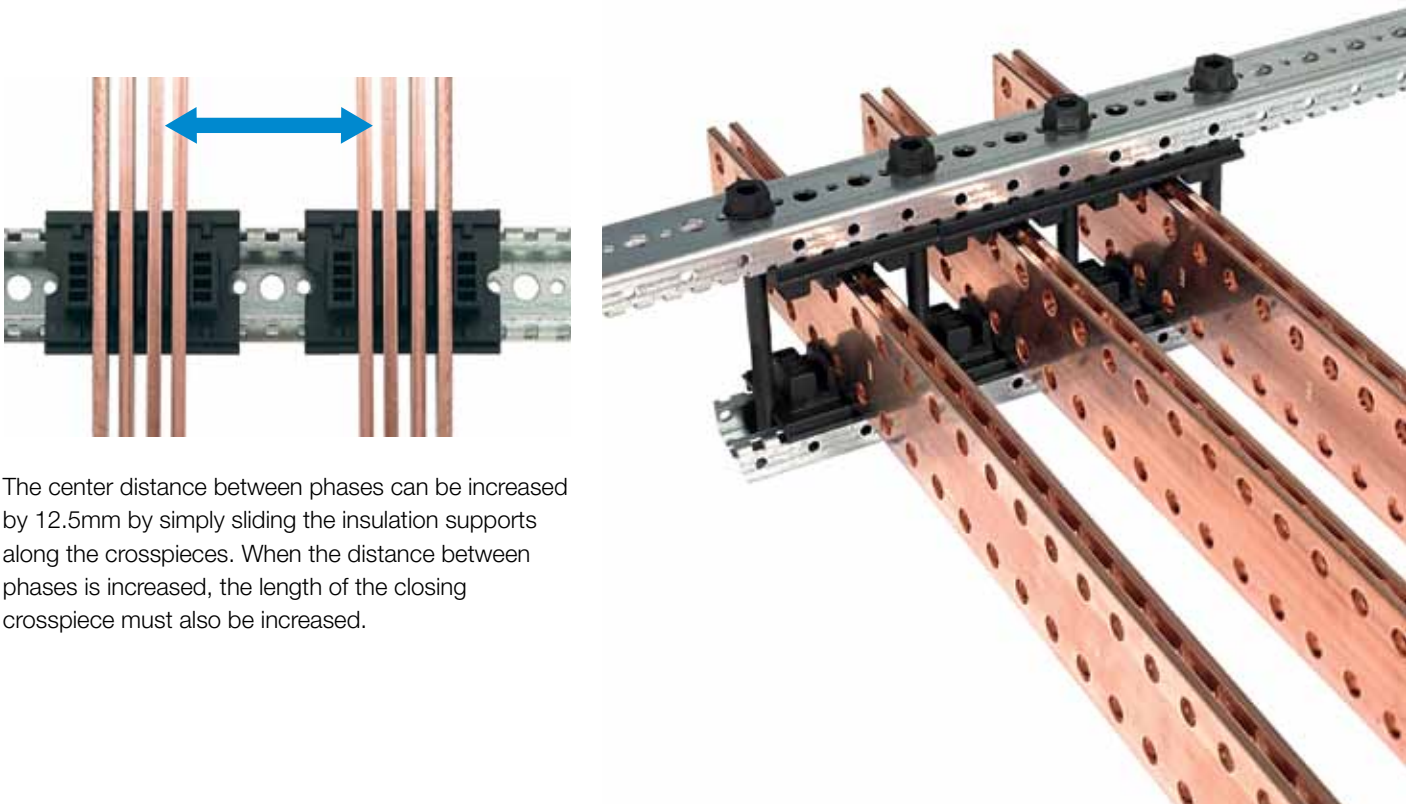

The center distance between phases can be increased by 12.5mm by simply sliding the insulation supports along the crosspieces. When the distance between phases is increased, the length of the closing crosspiece must also be increased.

System pro E power

General information

Advantages

- scalability: structure with modular insulating supports for 3P or 4P
- saving: the 4P system does not always have a full section neutral: the insulating supports allow structures of different sizes or with fewer insulating supports to be created, thus reducing costs.
- modularity: the linear system allows the center distance between the phases to be increased by spacing them at a 12.5mm pitch instead of installing them one against the other.
- sturdiness: the crosspieces can be coupled on the external side to make the busbar system sturdier.

Busbars installable with the insulating supports of the linear system

Length of insulating support	Notes	No. Flat busbars per phase	Slot dimensions	Maximum busbar H	Minimum busbar H
50mm	can house busbars on both sides	1x10mm	12mm slot	120x10	25x10
		2x5mm	9.5mm slot	120x5	20x5
75mm	can house busbars on both sides	2x10mm	12mm slot	120x10	25x10
		4x5mm	12mm slot	125x5	25x5
100mm	can house busbars on both sides	3x10mm	1mm slot	120x10	25x10
		2x10mm	12mm slot	120x10	25x10

All the shaped busbars can be housed in the insulating supports on a level with the slots for 10mm busbars.

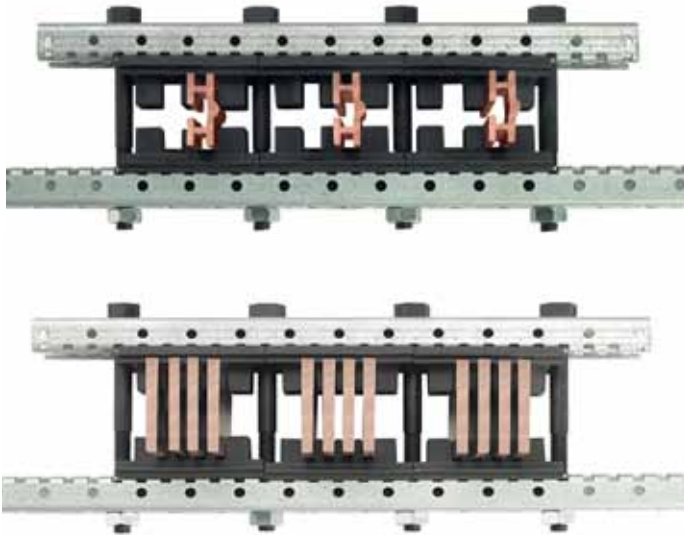

All the insulators are reversible and can house:
5mm and 10mm flat busbars and all shaped profile busbars

The scaled busbar holder can house flat busbars up to 2000A or shaped busbars up to 1600A.

SCALED SYSTEM

The insulating support is a single unit that can be screwed onto the crosspiece with the aid of a threaded spacer. The linear system is connected to the distribution busbars with tie rods, which are the same for all types of busbars.

Busbar system

- One single busbar support in thermoplastic that can house both flat busbars (5 and 10mm thick) and shaped profile busbars, thanks to the shape of the insulating support
- The same fixing crosspieces are used both for linear and scaled solutions

Busbars installable with the insulating supports of the scaled system

Insulating support	Notes	No. Flat busbars per phase	Slot dimensions	Maximum busbar H	Minimum busbar H
One type of insulating support	can house busbars on both sides	1x10mm	12mm slot	120x10	30x10
		2x5mm	9.5mm slot	125x5	20x5

All the shaped busbars can be housed in the insulating supports on a level with the slots for 10mm busbars.

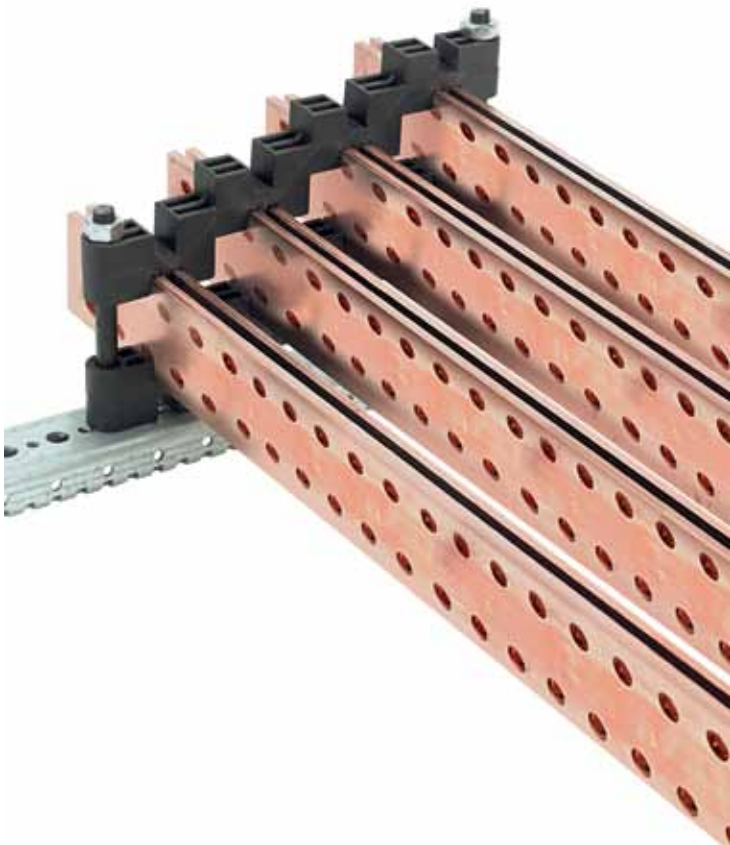

The scaled insulating supports house 5mm flat busbar systems on one side, while the other side houses 10mm flat busbars and all shaped profile busbars.

System pro E power

Selection guides

Fixing between uprights and crosspieces

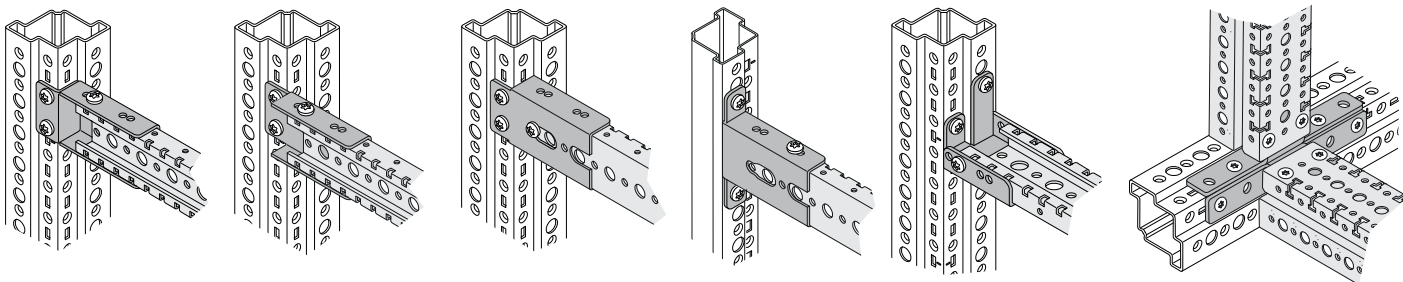

Fixing between crosspieces

5

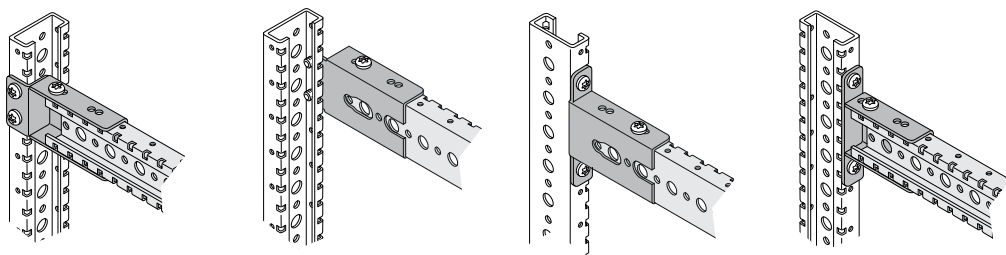

Crosspieces selections

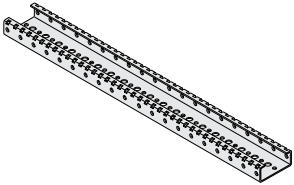
Description	Enclosure	Length [mm]	To be fitted in the following functional dimensions	Code
	Structure without intermediate upright	188	200	PCRM0188
		288	300	PCRM0288
		388	400	PCRM0388
		488	500	PCRM0488
		588	600	PCRM0588
		688	700	PCRM0688
		788	800	PCRM0788
		888	900	PCRM0888
		988	1000	PCRM0988
		1238	1250	PCRM1238
	Structure with vertical intermediate upright	238	500 with intermediate upright	PCRM0238
		338	600 with intermediate upright	PCRM0338
		438	700 with intermediate upright	PCRM0438
Any type	538	800 with intermediate upright	PCRM0538	
	638	900 with intermediate upright	PCRM0638	
Crosspieces with intermediate upright profile	Any type	738	1000 with intermediate upright	PCRM0738
		2013	To be cut according to the need	PCRM2013
		300	300	PCKI0300
		400	400	PCKI0400
		600	600	PCKI0600
		800	800	PCKI0800
		1000	1000	PCKI1000
		1250	1250	PCKI1250
1800	1800	PUKI1800		
2000	2000	PUKI2000		

> Order codes page 5/26 > Technical details page 7/1 > Overall dimensions page 8/1

Earth fixing

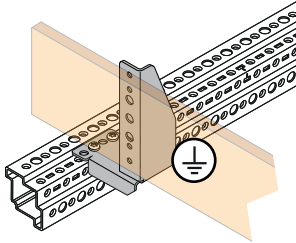

Neutral fixing

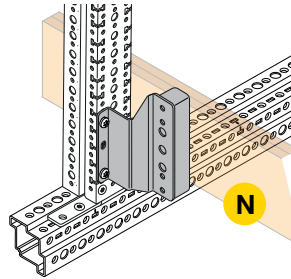

Brackets selections

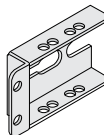
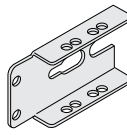
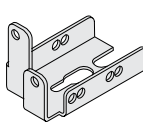
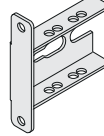
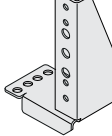
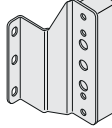
Description		Code
Bracket for crosspieces		PBBV0008
Bracket for crosspieces		PBTT0008
Bracket for crosspieces		PBBH0004
Bracket for crosspieces		PBMCO002
Bracket for PE busbar		PBRP0002
Bracket for Neutral busbar		PBRN0002

> Order codes page 5/26 > Technical details page 7/1 > Overall dimensions page 8/1

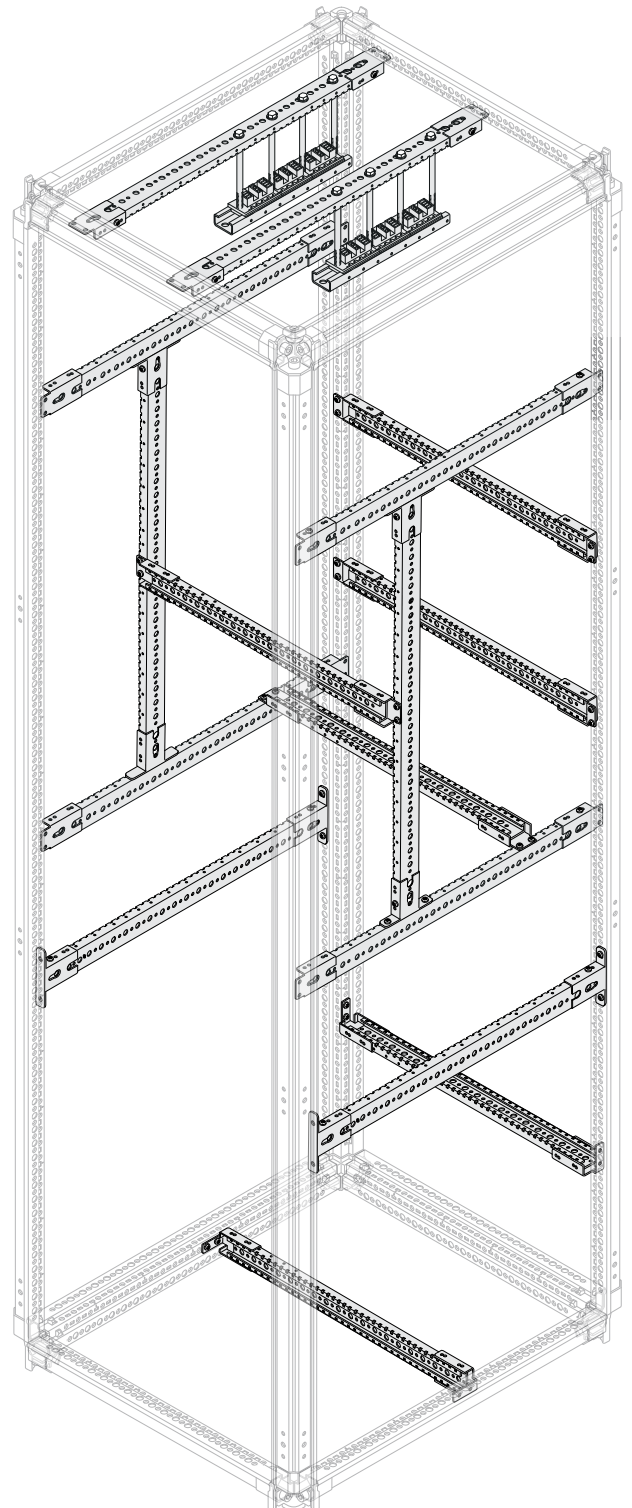

System pro E power

Selection guides

LINEAR SYSTEM - FLAT BUSBARS AND SHAPED BUSBARS

Fixing busbar holders to the structure.

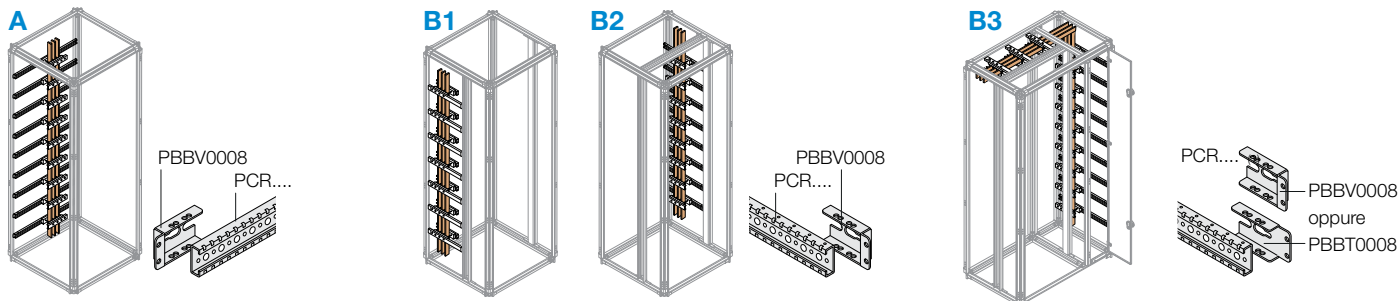

For vertical busbars in structure $D \geq 500\text{mm}$, the intermediate upright is always necessary

5

SUPPORTS FOR FIXING Crosspieces TO THE STRUCTURE (2 pieces per crosspiece)

A - Vertical busbars at the rear of the structure PBBV0008 ⁽¹⁾	B1 - vertical busbars on the side of the structure B2 - vertical busbars with horizontal busbars in the structure - PBBV0008
	B3 - vertical busbars in the cable compartment with horizontal busbars in the structure PBBV0008 ⁽¹⁾ - PBBT0008 ⁽²⁾ (table 1)

Crosspieces FOR BUSBAR HOLDERS (1 piece per busbar holder)

Structure W (mm)	Crosspiece in galvanized sheet metal	Crosspiece in stainless steel for $I_n \geq 4000\text{A}$	Structure D (mm)	Crosspiece in galvanized sheet metal	Crosspiece in galvanized sheet metal + intermediate upright	Crosspiece in stainless steel for $I_n \geq 4000\text{A}$ ⁽⁵⁾	Crosspiece in stainless steel for $I_n \geq 4000\text{A}$ + intermediate upright
300	PCRM0288		200	PCRM0188			
400	PCRM0388	PCRS0388	300	PCRM0288			
600	PCRM0588	PCRS0588	500	PCRM0488	PCRM0238		
800	PCRM0788	PCRS0788	700	PCRM0688	PCRM0438		PCRS0438
1000	PCRM0988	PCRS0988	900	PCRM0888	PCRM0638	PCRS0888	PCRS0638
1250	PCRM1238	PCRS1238					

⁽¹⁾ Use busbars with 100x10mm maximum section for structures with internal cable compartment $L=200\text{mm}$.

⁽²⁾ Use busbars with 80x10mm maximum section for structures with internal cable compartment $L=200\text{mm}$.

Table 1

Examples of the choice of supports for vertical busbars at the side

Position of the busbar holders		Supports for fixing vertical busbars
Horizontal busbars	Vertical busbars	
E+F	E o F	PBBT0008
E+F	G	PBBV0008
E+G	E o G	PBBT0008
E+G	F	PBBV0008

In case of separation Form 2b, 3b and 4b, use bracket PBBT0008.

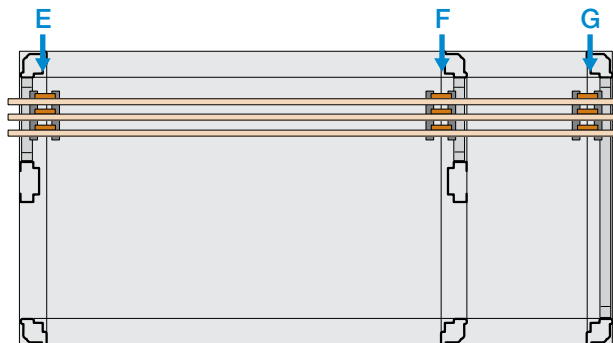

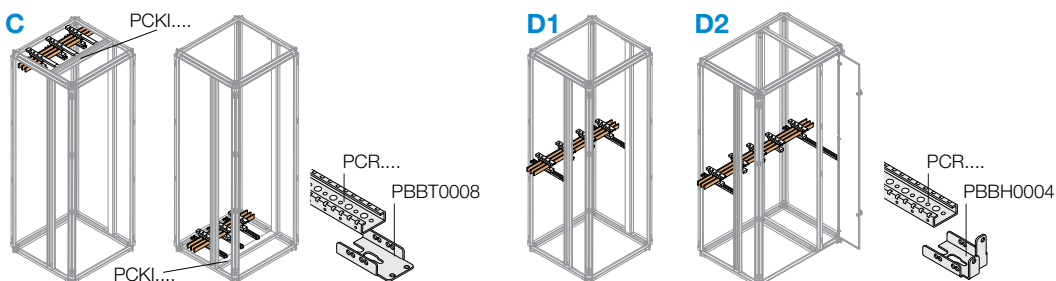

For horizontal busbars at each height in structure $D \geq 500\text{mm}$, the intermediate upright is always necessary

<p>C - Horizontal busbars under the top or on the bottom of the structure ⁽³⁾ PBBT0008 ⁽⁴⁾</p>	<p>D1 - Horizontal busbars at any height of the structure D2 - Horizontal busbars at any height of the structure and internal cable compartment PBBH0004</p>
---	---

Structure D (mm)	Crosspiece in galvanized sheet metal + intermediate crosspiece PCKI....	Crosspiece in stainless steel for $I_n \geq 4000A^{(5)}$ + intermediate crosspiece PCKI....	Structure D (mm)	Crosspiece in galvanized sheet metal ⁽⁶⁾	Crosspiece in galvanized sheet metal + intermediate upright	Crosspiece in stainless steel for $I_n \geq 4000A^{(5)(6)}$	Crosspiece in stainless steel for $I_n \geq 4000A$ + intermediate upright
			200	PCRM0188			
			300	PCRM0288			
500	PCRM0238		500	PCRM0488	PCRM0238		
700	PCRM0438	PCRS0438	700	PCRM0688	PCRM0438		PCRS0438
900	PCRM0638	PCRS0638	900	PCRM0888	PCRM0638	PCRS0888	PCRS0638

⁽³⁾ Order crosspieces PCKI.... to assemble busbars under the top or on the bottom, for assembly in $D > 300\text{mm}$ structures with internal cable compartment, order PCCM.... cable compartment depth crosspieces as well.

⁽⁴⁾ Supports for vertical busbars, if present, will always have code PBBV0008.

⁽⁵⁾ Only flat busbars.

⁽⁶⁾ In structures without intermediate upright, swing frame PFPS.... cannot be installed with horizontal busbars at all height.

System pro E power

Selection guides

LINEAR SYSTEM - COPPER FLAT BUSBARS

Choice of busbar holders and closing crosspieces in relation to the rated current I_n (A) and IP protection class.

PBHB1125

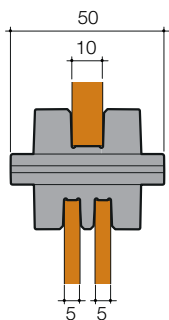

PBHB2145

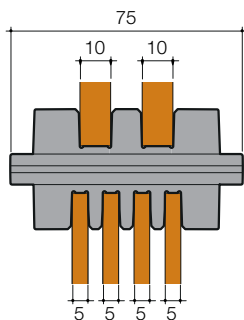

PBHB3121

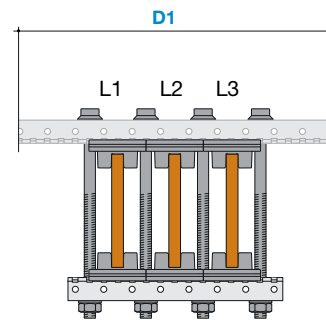
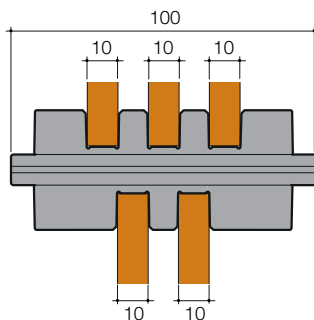

5

Description			Recommended D (busbar/circuit-breaker/connection interaction) 3/4 poli			3 poles		Overall dimensions crosspieces supports 3-pole D1 (mm)		
Capacity I_n (A)	Number of busbars per phase	Section (mm)	D \geq 300	D \geq 700	D=900	Busbars L1 L2 L3	Closing crosspiece 3-pole busbar holders 1 piece ⁽³⁾	D1=all	D1 \geq 300 ⁽¹⁾	D1 \geq 400 ⁽¹⁾
IP30 / IP31										
250	1	20x5	■			3xPBFC2005	PCRM0188	■		
400	1	25x5	■			3xPBFC2505	PCRM0188	■		
630	1	40x5	■			3xPBFC4005	PCRM0188	■		
800	1	30x10	■			3xPBFC3010	PCRM0188	■		
1000	1	80x5	■			3xPBFC8005	PCRM0188	■		
	1	40x10	■			3xPBFC4010	PCRM0188	■		
1250	1	100x5	■			3xPBFC1005	PCRM0188	■		
	1	50x10	■			3xPBFC5010	PCRM0188	■		
1600	2	80x5	■			6xPBFC8005	PCRM0188	■		
	1	80x10	■			3xPBFC8010	PCRM0188	■		
2000	2	100x5		■		6xPBFC1005	PCRM0188	■		
	2	50x10		■		6xPBFC5010	PCRM0288		■	
2500	4	80x5		■		12xPBFC8005	PCRM0288		■	
	2	80x10		■		6xPBFC8010	PCRM0288		■	
3200	4	100x5		■		12xPBFC1005	PCRM0288		■	
	2	100x10		■		6xPBFC1001	PCRM0288		■	
4000	3	100x10			■	9xPBFC1001	PCRM0338 ⁽²⁾			■
IP30 / IP31 / IP40 / IP41										
5000	3	160x10			■	9xPBFC1601	PCRS0338			■
7000	3	200x10			■	9xPBFC2001	PCRS0338			■
IP40 / IP41 / IP65										
250	1	20x5	■			3xPBFC2005	PCRM0188	■		
400	1	32x5	■			3xPBFC3205	PCRM0188	■		
630	1	50x5	■			3xPBFC5005	PCRM0188	■		
800	1	63x5	■			3xPBFC6305	PCRM0188	■		
1000	2	40x5	■			6xPBFC4005	PCRM0188	■		
1250	1	100x5	■			3xPBFC1005	PCRM0188	■		
1600	1	100x10	■			3xPBFC1001	PCRM0188	■		
2000	1	120x10		■		3xPBFC1201	PCRM0188	■		
2000	2	60x10		■		6xPBFC6010	PCRM0288		■	
2500	2	100x10		■		6xPBFC1001	PCRM0288		■	
3200	3	100x10		■		9xPBFC1001	PCRM0338			■
4000	3	120x10			■	9xPBFC1201	PCRS0338			■

⁽¹⁾ Excluding D=500mm with intermediate upright. ⁽²⁾ Use sheet metal crosspiece and nylon tie rods.

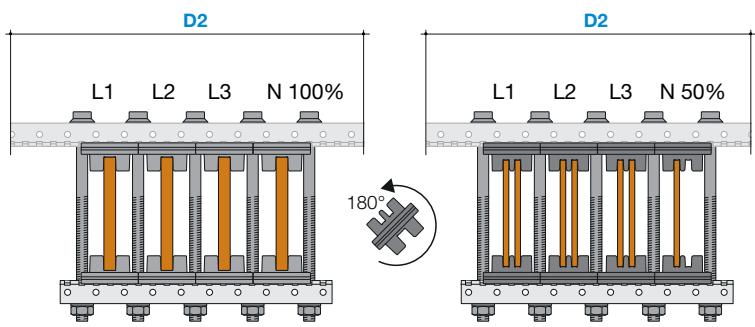

4 poles								Overall dimensions crosspieces supports 4-pole D2 (mm)			Insulators ⁽⁴⁾	Tie rods ⁽⁵⁾
Number of bus-bars per phase	Section (mm)	100% Neutral		50% Neutral		Closing cross-piece 4-pole busbar holders 1 piece ⁽³⁾	D2 ≥ 300	D2 ≥ 400 ⁽¹⁾	D2 ≥ 500 ⁽¹⁾	3 poles 6 pieces 4 poles 8 pieces	3 poles 4 pieces 4 poles 5 pieces	
		Number of bus-bars per phase	Section (mm)	Number of bus-bars per phase	Section (mm)							Busbars L1 L2 L3 50%N
1	20x5	4xPBFC2005	-	-	-	PCRM0238	■			PBHB1125	PTRN1951	
1	25x5	4xPBFC2505	-	-	-	PCRM0238	■			PBHB1125	PTRN1951	
1	40x5	4xPBFC4005	-	-	-	PCRM0238	■			PBHB1125	PTRN1951	
1	30x10	4xPBFC3010	-	-	-	PCRM0238	■			PBHB1125	PTRN1951	
1	80x5	4xPBFC8005	-	-	-	PCRM0238	■			PBHB1125	PTRN1951	
1	40x10	4xPBFC4010	-	-	-	PCRM0238	■			PBHB1125	PTRN1951	
1	100x5	4xPBFC1005	-	-	-	PCRM0238	■			PBHB1125	PTRN1951	
1	50x10	4xPBFC5010	-	-	-	PCRM0238	■			PBHB1125	PTRN1951	
2	80x5	8xPBFC8005	1	80x5	7xPBFC8005	PCRM0238	■			PBHB1125	PTRN1951	
1	80x10	4xPBFC8010	-	-	-	PCRM0238	■			PBHB1125	PTRN1951	
2	100x5	8xPBFC1005	1	100x5	7xPBFC1005	PCRM0238	■			PBHB1125	PTRN1951	
2	50x10	8xPBFC5010	1	50x10	7xPBFC5010	PCRM0338		■		PBHB2145	PTRN1951	
4	80x5	16xPBFC8005	2	80x5	14xPBFC8005	PCRM0338		■		PBHB2145	PTRN1951	
2	80x10	8xPBFC8010	1	-	7xPBFC8010	PCRM0338		■		PBHB2145	PTRN1951	
4	100x5	16xPBFC1005	2	100x5	14xPBFC1005	PCRM0338		■		PBHB2145	PTRN1951	
2	100x10	8xPBFC1001	1	-	7xPBFC1001	PCRM0338		■		PBHB2145	PTRN1951	
3	100x10	12xPBFC1001	2	100x10	11xPBFC1001	PCRM0438 ⁽²⁾			■	PBHB3121	PTRN1951 ⁽²⁾	
3	160x10	12xPBFC1601	2	-	11xPBFC1601	PCRS0438			■	PBHB3121	PTRS1601	
3	200x10	12xPBFC2001	2	-	11xPBFC2001	PCRS0438			■	PBHB3121	PTRS2001	
1	20x5	4xPBFC2005	-	-	-	PCRM0238	■			PBHB1125	PTRN1951	
1	32x5	4xPBFC3205	-	-	-	PCRM0238	■			PBHB1125	PTRN1951	
1	50x5	4xPBFC5005	-	-	-	PCRM0238	■			PBHB1125	PTRN1951	
1	63x5	4xPBFC6305	-	-	-	PCRM0238	■			PBHB1125	PTRN1951	
2	40x5	8xPBFC4005	1	40x5	7xPBFC4005	PCRM0238	■			PBHB1125	PTRN1951	
1	100x5	4xPBFC1005	-	-	-	PCRM0238	■			PBHB1125	PTRN1951	
1	100x10	4xPBFC1001	-	-	-	PCRM0238	■			PBHB1125	PTRN1951	
1	120x10	4xPBFC1201	-	-	-	PCRM0238	■			PBHB1125	PTRN1951	
2	60x10	8xPBFC6010	1	60x10	7xPBFC6010	PCRM0338		■		PBHB2145	PTRN1951	
2	100x10	8xPBFC1001	1	100x10	7xPBFC1001	PCRM0338		■		PBHB2145	PTRN1951	
3	100x10	12xPBFC1001	2	100x10	11xPBFC1001	PCRM0438			■	PBHB3121	PTRN1951	
3	120x10	12xPBFC1201	2	120x10	11xPBFC1201	PCRS0438			■	PBHB3121	PTRS1201	

⁽³⁾ When busbars with increased center distance are installed, the length of the closing crosspiece must also be increased.

⁽⁴⁾ The pack contains 24 pieces.

⁽⁵⁾ The pack contains 10 pieces.

System pro E power

Selection guides

LINEAR SYSTEM - CUPONAL FLAT BUSBARS

Choice of busbar holders and closing crosspieces in relation to the rated current I_n (A) and IP protection class.

PBHB1125

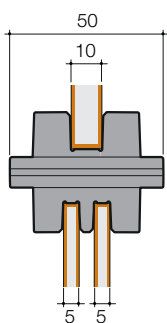

PBHB2145

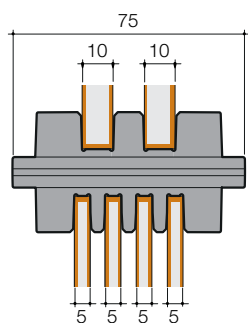

PBHB3121

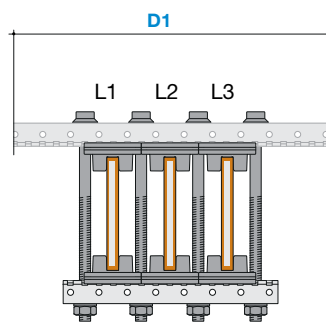
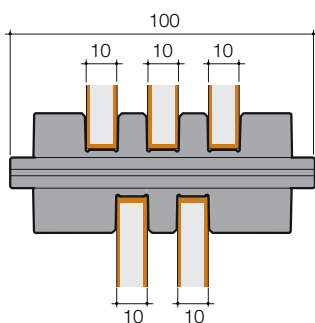

5

Description			Recommended D (busbar/circuit-breaker/connection interaction) 3/4 poli			3 poles		Overall dimensions crosspieces supports 3-pole D1 (mm)		
Capacity I_n (A)	Number of busbars per phase	Section (mm)	D \geq 300	D \geq 700	D=900	Busbars L1 L2 L3	Closing crosspiece 3-pole busbar holders 1 piece ⁽³⁾	D1=all	D1 \geq 300 ⁽¹⁾	D1 \geq 400 ⁽¹⁾
IP30 / IP31										
250	1	20x5	■			3xPBFA2005	PCRM0188	■		
400	1	30x5	■			3xPBFA3005	PCRM0188	■		
630	1	50x5	■			3xPBFA5005	PCRM0188	■		
800	1	40x10	■			3xPBFA4010	PCRM0188	■		
1000	1	50x10	■			3xPBFA5010	PCRM0188	■		
1000	2	40x5	■			6xPBFA4005	PCRM0188	■		
1250	1	75x10	■			3xPBFA7510	PCRM0188	■		
1250	2	60x5	■			6xPBFA6005	PCRM0188	■		
1600	2	80x5	■			6xPBFA8005	PCRM0188	■		
2000	1	120x10		■		3xPBFA1201	PCRM0188	■		
2000	4	50x5		■		12xPBFA5005	PCRM0288		■	
2500	2	80x10		■		6xPBFA8010	PCRM0288		■	
2500	4	80x5		■		12xPBFA8005	PCRM0288		■	
3200	2	120x10		■		6xPBFA1201	PCRM0288		■	
IP65										
250	1	25x5	■			3xPBFA2505	PCRM0188	■		
400	1	40x5	■			3xPBFA4005	PCRM0188	■		
630	1	60x5	■			3xPBFA6005	PCRM0188	■		
800	1	80x5	■			3xPBFA8005	PCRM0188	■		
1000	2	50x5	■			6xPBFA5005	PCRM0188	■		
1250	1	80x10	■			3xPBFA8010	PCRM0188	■		
1600	1	100x10	■			3xPBFA1001	PCRM0188	■		
2000	2	75x10		■		6xPBFA7510	PCRM0288		■	
2500	2	100x10		■		6xPBFA1001	PCRM0288		■	
3200	3	100x10		■		9xPBFA1001	PCRM0338			■

⁽¹⁾ Excluding D=500mm with intermediate upright. ⁽²⁾ Use sheet metal crosspiece and nylon tie rods.

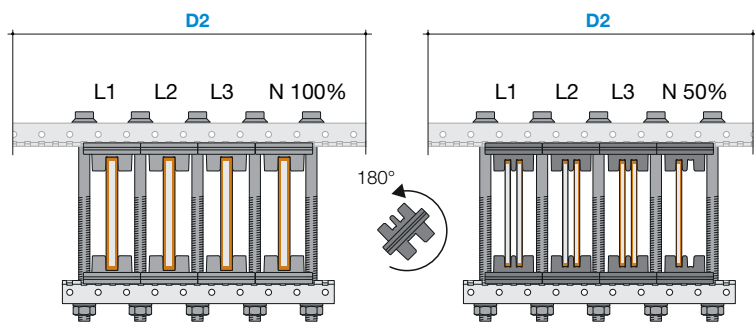

4 poles								Overall dimensions crosspieces supports 4-pole D2 (mm)			Insulators ⁽⁴⁾	Tie rods ⁽⁵⁾
Number of bus-bars per phase	Section (mm)	100% N		50% Neutral busbars per phase		Closing crosspiece 4-pole busbar holders 1 piece ⁽³⁾	D2≥300	D2≥400 ⁽¹⁾	D2≥500 ⁽¹⁾	3 poles 6 pieces 4 poles 8 pieces	3 poles 4 pieces 4 poles 5 pieces	
		Number of bus-bars per phase	Section (mm)	Busbars L1 L2 L3 50%N	Section (mm)							
1	20x5	4	PBFA2005	-	-	PCRM0238	■			PBHB1125	PTRN1951	
1	30x5	4	PBFA3005	-	-	PCRM0238	■			PBHB1125	PTRN1951	
1	50x5	4	PBFA5005	-	-	PCRM0238	■			PBHB1125	PTRN1951	
1	40x10	4	PBFA4010	-	-	PCRM0238	■			PBHB1125	PTRN1951	
1	50x10	4	PBFA5010	-	-	PCRM0238	■			PBHB1125	PTRN1951	
2	40x5	8	PBFA4005	1	40x5	7xPBFA4005	■			PBHB1125	PTRN1951	
1	75x10	4	PBFA7510	-	-	PCRM0238	■			PBHB1125	PTRN1951	
2	60x5	8	PBFA6005	1	60x5	7xPBFA6005	■			PBHB1125	PTRN1951	
2	80x5	8	PBFA8005	1	80x5	7xPBFA8005	■			PBHB1125	PTRN1951	
1	120x10	4	PBFA1201	-	-	PCRM0238	■			PBHB1125	PTRN1951	
4	50x5	16	PBFA5005	2	50x5	14xPBFA5005	■	■		PBHB2145	PTRN1951	
2	80x10	8	PBFA8010	1	-	7xPBFA8010	■	■		PBHB2145	PTRN1951	
4	80x5	16	PBFA8005	2	80x5	14xPBFA8005	■	■		PBHB2145	PTRN1951	
2	120x10	8	PBFA1201	1	120x10	7xPBFA1201	■	■		PBHB2145	PTRN1951	
1	25x5	4	PBFA2505	-	-	PCRM0238	■			PBHB1125	PTRN1951	
1	40x5	4	PBFA4005	-	-	PCRM0238	■			PBHB1125	PTRN1951	
1	60x5	4	PBFA6005	-	-	PCRM0238	■			PBHB1125	PTRN1951	
1	80x5	4	PBFA8005	-	-	PCRM0238	■			PBHB1125	PTRN1951	
2	50x5	8	PBFA5005	1	50x5	7xPBFA5005	■			PBHB1125	PTRN1951	
1	80x10	4	PBFA8010	-	-	PCRM0238	■			PBHB1125	PTRN1951	
1	100x10	4	PBFA1001	-	-	PCRM0238	■			PBHB1125	PTRN1951	
2	75x10	8	PBFA7510	1	-	7xPBFA7510	■	■		PBHB2145	PTRN1951	
2	100x10	8	PBFA1001	1	-	7xPBFA1001	■	■		PBHB2145	PTRN1951	
3	100x10	12	PBFA1001	2	100x10	11xPBFA1001	■		■	PBHB3121	PTRN1951	

⁽³⁾ When busbars with increased center distance are installed, the length of the closing crosspiece must also be increased.

⁽⁴⁾ The pack contains 24 pieces.

⁽⁵⁾ The pack contains 10 pieces.

System pro E power

Selection guides

LINEAR SYSTEM - SHAPED BUSBARS

Choice of busbar holders and closing crosspieces in relation to rated current I_n (A) and IP protection class.

PBHB1125

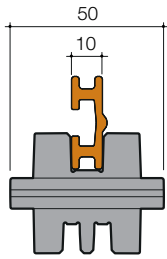

PBHB2145

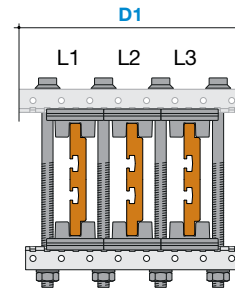
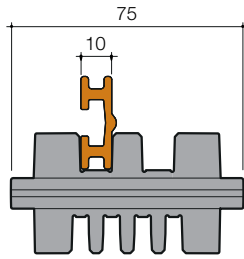

5

Capacity I_n (A)			Number of busbars per phase	WxW (mm)	Section (mm ²)	Busbars	Recommended D (busbar/ circuit-breaker/connection interaction)		3 poles			Overall dimensions crosspieces supports 3-pole D1 (mm)	
							D \geq 300	D \geq 700	L1	L2	L3	Closing crosspiece 3-pole busbar holder 1 piece	D1=all
IP30/31	IP40/41	IP65											
475	440	400	1	30x10	165	PBSC0400	■		3xPBSC0400	PCRM0188	■		
655	643	630	1	35x10	204	PBSC0630	■		3xPBSC0630	PCRM0188	■		
958	840	800	1	45x10	324	PBSC0800	■		3xPBSC0800	PCRM0188	■		
1342	1220	1000	1	67x10	454	PBSC1000	■		3xPBSC1000	PCRM0188	■		
1418	1338	1250	1	70x10	516	PBSC1250	■		3xPBSC1250	PCRM0188	■		
1857	1744	1600	1	95x10	758	PBSC1600	■		3xPBSC1600	PCRM0188	■		
2354	2200	2000	1	105x15	995	PBSC2000		■	3xPBSC2000	PCRM0288		■	
2860	2750	2500	1	105x15	1255	PBSC2500		■	3xPBSC2500	PCRM0288		■	

⁽¹⁾ Excluding D=500mm with intermediate upright.

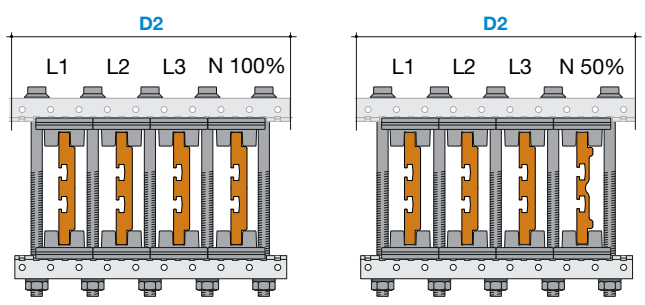

4 poles			Overall dimensions crosspieces supports 4-pole D2 (mm)		Insulators ⁽³⁾	Tie rods ⁽⁴⁾
100% Neutral	50% Neutral	Closing crosspiece 4-pole busbar holder 1 piece ⁽²⁾	D2 ≥ 300	D2 ≥ 400 ⁽¹⁾	3 poles 6 pieces 4 poles 8 pieces	3 poles 4 pieces 4 poles 5 pieces
4xPBSC0400	-	PCRM0238	■		PBHB1125	PTRN1951
4xPBSC0630	-	PCRM0238	■		PBHB1125	PTRN1951
4xPBSC0800	-	PCRM0238	■		PBHB1125	PTRN1951
4xPBSC1000	-	PCRM0238	■		PBHB1125	PTRN1951
4xPBSC1250	-	PCRM0238	■		PBHB1125	PTRN1951
4xPBSC1600	-	PCRM0238	■		PBHB1125	PTRN1951
4xPBSC2000	-	PCRM0338		■	PBHB2145	PTRN1951
4xPBSC2500	3xPBSC2500 + 1xPBSC2000	PCRM0338		■	PBHB2145	PTRN1951

⁽³⁾ When busbars with increased center distance are installed, the length of the closing crosspiece must also be increased.

⁽⁴⁾ The pack contains 24 pieces.

⁽⁵⁾ The pack contains 10 pieces.

System pro E power

Selection guides

LINEAR SYSTEM - FLAT BUSBARS AND SHAPED BUSBARS

Choice and assembly of the number of busbar holders, in relation to maximum I_{cw}

Use of the correct number of busbar holders guarantees electrodynamic stress withstand in the event of a short-circuit. Establish the maximum distance (X_{max}) which must not be exceeded between two consecutive busbar holders, in relation to the maximum I_{cw} .

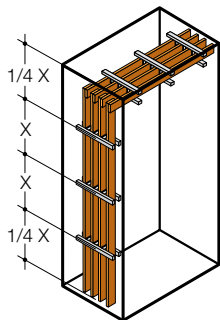

The distance between the first busbar holder and the end of the busbar must not exceed $1/4$ of "X".

5

Copper busbars

Description							No. busbar holders Lenght =1750mm in relation to I_{cw} max														
Capacity In (A)	Number of busbars per phase			WxW (mm)	Busbar	Insulators	15 kA	X max	25 kA	X max	36 kA	X max	50 kA	X max	65 kA	X max	75 kA	X max	85 kA	X max	
IP30/31	IP40/41	IP65																			
FLAT BUSBARS																					
250	250	250	1	20x5	PBFC2005	PBHB1125	7	275	-	-	-	-	-	-	-	-	-	-	-	-	
400	-	-	1	25x5	PBFC2505	PBHB1125	7	300	9	200	-	-	-	-	-	-	-	-	-	-	
-	400	400	1	32x5	PBFC3205	PBHB1125	5	450	7	275	-	-	-	-	-	-	-	-	-	-	
630	-	-	1	40x5	PBFC4005	PBHB1125	5	450	7	300	9	200	-	-	-	-	-	-	-	-	
-	630	630	1	50x5	PBFC5005	PBHB1125	5	475	7	300	9	225	-	-	-	-	-	-	-	-	
800	-	-	1	30x10	PBFC3010	PBHB1125	4	525	5	450	7	300	-	-	-	-	-	-	-	-	
-	800	800	1	63x5	PBFC6305	PBHB1125	4	525	5	425	6	325	-	-	-	-	-	-	-	-	
1000	-	-	1	40x10	PBFC4010	PBHB1125	4	525	5	450	6	375	9	225	-	-	-	-	-	-	
-	1000	1000	2	40x5	PBFC4005	PBHB1125	4	525	5	475	6	375	-	-	-	-	-	-	-	-	
1000	-	-	1	80x5	PBFC8005	PBHB1125	4	525	5	475	6	375	9	225	-	-	-	-	-	-	
1250	1250	1250	1	100x5	PBFC1005	PBHB1125	3	1000	4	525	6	375	7	275	-	-	-	-	-	-	
1250	-	-	1	50x10	PBFC5010	PBHB1125	3	1000	4	525	6	375	8	250	9	200	-	-	-	-	
-	1600	1600	1	100x10	PBFC1001	PBHB1125	3	1000	4	550	4	500	6	325	9	200	-	-	-	-	
1600	-	-	1	80x10	PBFC8010	PBHB1125	3	1000	4	525	5	475	7	300	9	200	-	-	-	-	
1600	-	-	2	80x5	PBFC8005	PBHB1125	3	1000	4	525	5	475	7	300	9	200	-	-	-	-	
2000	-	-	2	100x5	PBFC1005	PBHB1125	3	1000	4	550	4	500	6	325	9	200	-	-	-	-	
-	2000	2000	1	120x10	PBFC1201	PBHB1125	3	1000	4	550	4	500	6	325	9	200	-	-	-	-	
2000	-	-	2	50x10	PBFC5010	PBHB2145	3	1000	4	525	6	375	8	250	9	200	-	-	-	-	
-	2000	2000	2	60x10	PBFC6010	PBHB2145	3	1000	4	525	6	375	8	250	9	200	-	-	-	-	
2500	-	-	2	80x10	PBFC8010	PBHB2145	3	1000	3	1000	4	525	5	400	7	275	9	200	-	-	
2500	-	-	4	80x5	PBFC8005	PBHB2145	3	1000	3	1000	4	525	5	400	7	275	9	200	-	-	
3200	2500	2500	2	100x10	PBFC1001	PBHB2145	3	1000	3	1000	4	525	5	400	7	300	7	275	8	250	
3200	-	-	4	100x5	PBFC1005	PBHB2145	3	1000	3	1000	4	525	5	400	7	275	9	200	-	-	
4000	3200	3200	3	100x10	PBFC1001	PBHB3121	3	1000	3	1000	3	750	4	500	5	400	6	350	7	275	
-	4000	4000	3	120x10	PBFC1201	PBHB3121	3	1000	3	1000	3	750	4	500	5	400	6	350	7	275	
5000	5000	-	3	160x10	PBFC1601	PBHB3121	3	1000	3	1000	3	1000	3	750	5	400	6	350	7	275	
7000	7000	-	3	200x10	PBFC2001	PBHB3121	3	1000	3	1000	3	1000	3	750	5	400	6	350	7	275	
SHAPED BUSBARS																					
475	440	400	1	30x10	PBSC0400	PBHB1125	4	525	5	450	-	-	-	-	-	-	-	-	-	-	
655	643	630	1	35x10	PBSC0630	PBHB1125	4	525	5	450	7	300	-	-	-	-	-	-	-	-	
958	840	800	1	45x10	PBSC0800	PBHB1125	4	525	5	450	6	375	-	-	-	-	-	-	-	-	
1342	1220	1000	1	67x10	PBSC1000	PBHB1125	4	525	5	450	6	375	9	225	-	-	-	-	-	-	
1418	1338	1250	1	70x10	PBSC1250	PBHB1125	3	1000	4	525	6	375	8	250	-	-	-	-	-	-	
1857	1744	1600	1	95x10	PBSC1600	PBHB1125	3	1000	4	550	5	400	7	275	9	200	-	-	-	-	
2354	2200	2000	1	105x15	PBSC2000	PBHB2145	3	1000	4	550	4	500	6	325	9	225	9	200	-	-	
2860	2750	2500	1	105x15	PBSC2500	PBHB2145	3	1000	3	1000	4	525	5	400	7	275	9	200	-	-	

> Order codes page 5/26 > Technical details page 7/1 > Overall dimensions page 8/1

System pro E power

Selection guides

SCALED SYSTEM-FLAT BUSBARS

Fixing busbar holders to the structure.

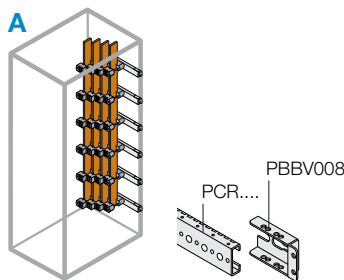

SUPPORTS FOR FIXING CROSSPIECES TO THE STRUCTURE (2 pieces per crosspiece)

A - Vertical busbars at the side of the structure

PBBV0008 ⁽¹⁾

CROSSPIECES FOR BUSBAR HOLDERS (1 piece per busbar holder)

Structure P (mm)	Crosspiece in galvanized sheet metal	Crosspiece in galvanized sheet metal + intermediate upright
300	PCRM0288	
500	PCRM0488	PCRM0238
700	PCRM0688	PCRM0438
900	PCRM0888	PCRM0638

⁽¹⁾ Use busbars with 50x10mm maximum section for structures with internal cable compartment L=200mm.

Choice of busbar holders in relation to rated current I_n (A) and IP protection class.

Copper busbars

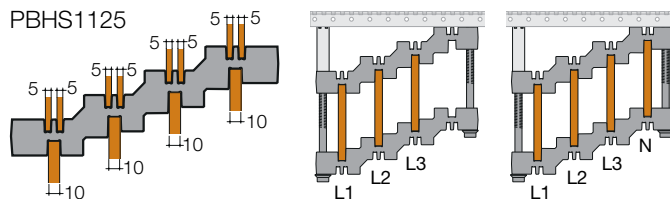

Capacity I _n (A)	Number of busbars per phase	WxW (mm)	Switchboard installation Minimum depth (mm)		3/4-pole insulator complete with tie rods ⁽²⁾	3 poles	4 poles
			D≥300	D≥700		Busbars L1 L2 L3	Busbars L1 L2 L3+ 100% Neutral
IP30 / IP31							
250A	1	20x5	■		PBHS1125	3xPBFC2005	4xPBFC2005
400A	1	25x5	■		PBHS1125	3xPBFC2505	4xPBFC2505
630A	1	40x5	■		PBHS1125	3xPBFC4005	4xPBFC4005
800A	1	30x10	■		PBHS1125	3xPBFC3010	4xPBFC3010
1000A	1	80x5	■		PBHS1125	3xPBFC8005	4xPBFC8005
1000A	1	40x10	■		PBHS1125	3xPBFC4010	4xPBFC4010
1250A	1	100x5	■		PBHS1125	3xPBFC1005	4xPBFC1005
1250A	1	50x10	■		PBHS1125	3xPBFC5010	4xPBFC5010
1600A	2	80x5	■		PBHS1125	6xPBFC8005	8xPBFC8005
1600A	1	80x10	■		PBHS1125	3xPBFC8010	4xPBFC8010
2000A	2	100x5		■ ⁽¹⁾	PBHS1125	6xPBFC1005	8xPBFC1005
IP40 / IP41 / 65							
250A	1	20x5	■		PBHS1125	3xPBFC2005	4xPBFC2005
400A	1	32x5	■		PBHS1125	3xPBFC3205	4xPBFC3205
630A	1	50x5	■		PBHS1125	3xPBFC5005	4xPBFC5005
800A	1	63x5	■		PBHS1125	3xPBFC6305	4xPBFC6305
1000A	2	40x5	■		PBHS1125	6xPBFC4005	8xPBFC4005
1250A	1	100x5	■		PBHS1125	3xPBFC1005	4xPBFC1005
1600A	1	100x10	■		PBHS1125	3xPBFC1001	4xPBFC1001
2000A	1	120x10		■ ⁽¹⁾	PBHS1125	3xPBFC1201	4xPBFC1201

⁽¹⁾Theoretic dimension D≥300mm; with busbar /circuit-breaker / connection interaction D≥700mm.

⁽²⁾ The package contains 1 scaled busbar holder provided with spacer, nylon tie-rods and 2 insulators.

> Order codes page 5/26 > Technical details page 7/1 > Overall dimensions page 8/1

SCALED SYSTEM-FLAT BUSBARS

Choice of busbar holders in relation to rated current I_n (A) and IP protection class.

Barre in cuponal

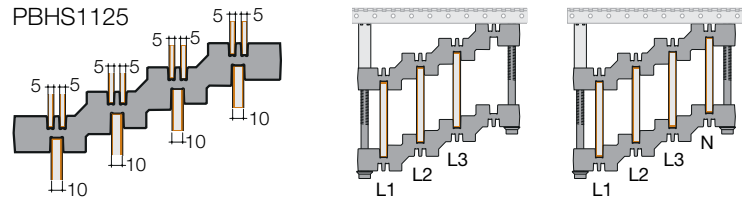

Capacity I_n (A)	Number of busbars per phase	WxW (mm)	Switchboard installation Minimum depth (mm)		3/4-pole insulator complete with tie rods ⁽¹⁾	3 poles			4 poles
			$P \geq 300$	$P \geq 700$		Busbars L1 L2 L3			Busbars L1 L2 L3+ 100% Neutral
IP30 / IP31									
250	1	20x5	■		PBHS1125	3xPBFA2005			4xPBFA2005
400	1	30x5	■		PBHS1125	3xPBFA3005			4xPBFA3005
630	1	50x5	■		PBHS1125	3xPBFA5005			4xPBFA5005
800	1	40x10	■		PBHS1125	3xPBFA4010			4xPBFA4010
1000	1	50x10	■		PBHS1125	3xPBFA5010			4xPBFA5010
1000	2	40x5	■		PBHS1125	6xPBFA4005			8xPBFA4005
1250	1	75x10	■		PBHS1125	3xPBFA7510			4xPBFA7510
1250	2	60x5	■		PBHS1125	6xPBFA6005			8xPBFA6005
1600	2	80x5	■		PBHS1125	6xPBFA8005			8xPBFA8005
2000	1	120x10		■	PBHS1125	3xPBFA1201			4xPBFA1201
IP40 / IP41 / 65									
250	1	25x5	■		PBHS1125	3xPBFA2505			4xPBFA2505
400	1	40x5	■		PBHS1125	3xPBFA4005			4xPBFA4005
630	1	60x5	■		PBHS1125	3xPBFA6005			4xPBFA6005
800	1	80x5	■		PBHS1125	3xPBFA8005			4xPBFA8005
1000	2	50x5	■		PBHS1125	6xPBFA5005			8xPBFA5005
1250	1	80x10	■		PBHS1125	3xPBFA8010			4xPBFA8010
1600	1	100x10	■		PBHS1125	3xPBFA1001			4xPBFA1001

⁽¹⁾ The package contains 1 scaled busbar holder provided with spacer, nylon tie-rods and 2 insulators.

SCALED SYSTEM - SHAPED BUSBARS

Choice of busbar holders in relation to rated current I_n (A) and IP protection class.

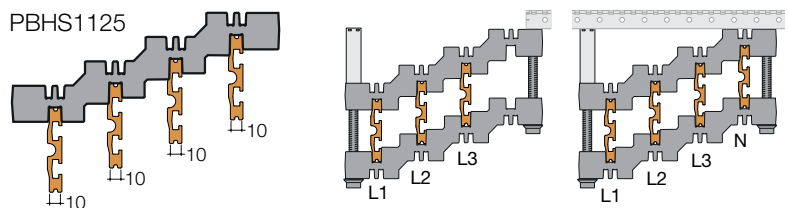

Capacity I_n (A)			Number of busbars per phase	WxW (mm)	Section (mm ²)	Switchboard installation Minimum depth (mm)		3/4-pole insulator complete with tie rods ⁽¹⁾	3 poles			4 poles
IP30/31	IP40/41	IP65				$D \geq 300$	Busbars L1 L2 L3			Busbars L1 L2 L3+ 100% Neutral		
475	440	400	1	30x10	165	■		PBHS1125	3xPBSC0400			4xPBSC0400
655	643	630	1	35x10	204	■		PBHS1125	3xPBSC0630			4xPBSC0630
958	840	800	1	45x10	324	■		PBHS1125	3xPBSC0800			4xPBSC0800
1342	1220	1000	1	67x10	454	■		PBHS1125	3xPBSC1000			4xPBSC1000
1418	1338	1250	1	70x10	516	■		PBHS1125	3xPBSC1250			4xPBSC1250
1857	1744	1600	1	95x10	758	■		PBHS1125	3xPBSC1600			4xPBSC1600

⁽¹⁾ The package contains 1 scaled busbar holder provided with spacer, nylon tie-rods and 2 insulators.

System pro E power

Selection guides

SCALED SYSTEM - FLAT BUSBARS AND SHAPED BUSBARS

Choice and assembly of the number of busbar holders, in relation to maximum I_{cw}

Use of the correct number of busbar holders guarantees electrodynamic stress withstand in the event of a short-circuit. Establish the maximum distance (X max) which must not be exceeded between two consecutive busbar holders, in relation to the maximum I_{cw} .

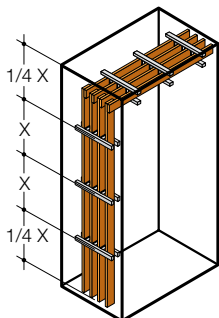

The distance between the first busbar holder and the end of the busbar must not exceed $1/4$ of "X".

5

Copper busbars

Description							No. busbar holders Length =1750mm in relation to I_{cw} max					
Capacity In (A)			Number of busbars per phase	WxW (mm)	BUSBAR	Insulators	15 kA	X max	25 kA	X max	36 kA	X max
IP30/31	IP40/41	IP65										
FLAT BUSBARS												
250	250	250	1	20x5	PBFC2005	PBHS1125	9	200	-	-	-	-
400	-	-	1	25x5	PBFC2505	PBHS1125	7	300	-	-	-	-
-	400	400	1	32x5	PBFC3205	PBHS1125	7	300	9	200	-	-
630	-	-	1	40x5	PBFC4005	PBHS1125	7	300	9	200	-	-
-	630	630	1	50x5	PBFC5005	PBHS1125	5	450	7	275	9	200
800	-	-	1	30x10	PBFC3010	PBHS1125	5	450	6	375	9	225
-	800	800	1	63x5	PBFC6305	PBHS1125	4	525	5	425	6	325
1000	-	-	1	40x10	PBFC4010	PBHS1125	4	525	5	450	6	375
-	1000	1000	2	40x5	PBFC4005	PBHS1125	4	525	5	475	7	300
1000	-	-	1	80x5	PBFC8005	PBHS1125	4	525	5	475	6	375
1250	1250	1250	1	100x5	PBFC1005	PBHS1125	4	525	4	525	6	375
1250	-	-	1	50x10	PBFC5010	PBHS1125	4	525	4	525	6	375
-	1600	1600	1	100x10	PBFC1001	PBHS1125	4	550	4	550	5	475
1600	-	-	1	80x10	PBFC8010	PBHS1125	4	525	4	525	5	475
1600	-	-	2	80x5	PBFC8005	PBHS1125	4	525	4	525	6	375
2000	-	-	2	100x5	PBFC1005	PBHS1125	4	550	5	425	6	375
-	2000	2000	1	120x10	PBFC1201	PBHS1125	4	550	4	550	5	475
SHAPED BUSBARS												
475	440	400	1	30x10	PBSC0400	PBHS1125	5	450	6	375	9	225
655	643	630	1	35x10	PBSC0630	PBHS1125	5	450	6	375	9	225
958	840	800	1	45x10	PBSC0800	PBHS1125	4	525	5	425	6	325
1342	1220	1000	1	67x10	PBSC1000	PBHS1125	4	525	5	450	6	375
1418	1338	1250	1	70x10	PBSC1250	PBHS1125	4	525	4	525	6	375
1857	1744	1600	1	95x10	PBSC1600	PBHS1125	4	550	4	550	5	475

Cuponal busbars

			Description					No. busbar holders Lenght =1750mm in relation to l _{cw} max							
	50 kA	X max	Capacity In (A)	Number of bus-bars per phase	WxW (mm)	BUSBAR	Insulators	15 kA	X max	25 kA	X max	36 kA	X max	50 kA	X max
FLAT BUSBARS IP30/31															
-	-	-	250	1	20x5	PBFA2005	PBHS1125	13	175						
-	-	-	400	1	30x5	PBFA3005	PBHS1125	10	225						
-	-	-	630	1	50x5	PBFA5005	PBHS1125	10	225	13	175				
-	-	-	800	1	40x10	PBFA4010	PBHS1125	7	275	9	250	13	175		
-	-	-	1000	1	50x10	PBFA5010	PBHS1125	6	325	7	275	9	250	13	175
9	200		1000	2	40x5	PBFA4005	PBHS1125	6	325	7	275	9	250	13	175
9	200		1250	1	75x10	PBFA7510	PBHS1125	6	325	6	325	9	250	12	200
-	-	-	1250	2	60x5	PBFA6005	PBHS1125	6	325	6	325	9	250	12	200
9	200		1600	2	80x5	PBFA8005	PBHS1125	6	325	6	325	9	250		
8	250		2000	1	120x10	PBFA1201	PBHS1125	6	325	7	275	9	250		
8	250														
6	325														
7	300														
-	-	-													
-	-	-													
7	300														
-	-	-													
-	-	-													
9	200														
9	200														
8	250														
6	325														
-	-	-													
-	-	-													
9	200														
9	200														
8	250														
6	325														
-	-	-													
-	-	-													
9	200														
9	200														
8	250														
6	325														

System pro E power

Selection guides

Compensators and connections for flat and shaped busbar

5

		Shaped busbars								
		In	400A	630A	800A	1000A	1250A	1600A	2000A	2500A
Shaped busbars	In									
	400A	PFCB4080							PFCB4080	
	630A	PFCB4080							PFCB4080	
	800A	PFCB4080							PFCB4080	
	1000A					PFCB1016			PFCB1016	
	1250A					PFCB1016			PFCB1016	
	1600A					PFCB1016	PFCB2025		PFCB2025	
	2000A					2x PFCB2025		2x PFCB2025		
2500A							2x PFCB2025			

PFCB4080 – Connections between shaped busbar/shaped busbar or shaped busbar/flat busbar for 400A, 630A, 800A

PFCB1016 – Connections between shaped busbar/shaped busbar or shaped busbar/flat busbar for 1000A, 1250A, 1600A

PFCB2025 – Connections between shaped busbar/shaped busbar or shaped busbar/flat busbar for 2000A, 2500A

PFCC0023 – Compensator for configurations compose of no. of busbar per phase>1

The connections can be used also for joining flat busbar/ shaped busbar (as per the chart above) if the following conditions are fulfilled:

- use of insulating support of the same size both in H and in V
- use of flat busbar with 10mm thickness

In case of joining a main flat busbar system composed of more than one busbar per phase and shaped busbar distribution system, it is recommended to align the shaped busbar to the flat busbar in the most rearward position.

The number of code for connection shall be multiplied by the number of phases included into the busbars system.

Example

Connection between shaped busbars 2500A and flat busbars 2500A

3P busbars system	6 x PFCB2025 + 3 x PFCC0029
4P busbars system	8 x PFCB2025 + 4 x PFCC0029

Flat busbars												
800A	1000A	1250A	1600A	2000A	2000A	2500A	3200A	3200A	4000A	5000A	6300A	
1 Busbar for phase					2 Busbars for phase			3 Busbars for phase				
PFCB4080								PFCB4080 + PFCC0023				
PFCB4080								PFCB4080 + PFCC0023				
PFCB4080								PFCB4080 + PFCC0023				
		PFCB1016						PFCB1016 + PFCC0023				
		PFCB1016						PFCB1016 + PFCC0023				
		PFCB2025						PFCB2025 + PFCC0023				
					2x PFCB2025 + PFCC0023							
					2x PFCB2025 + PFCC0023							

Examples of use

Flat busbars 2 for phase
Shaped busbar ≤ 2000A

PFCB4080 or PFCB1016 or PFCB2025

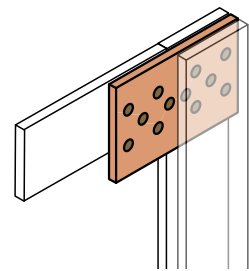
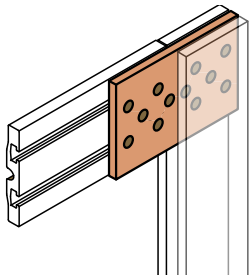

Flat busbars 2 for phase
Shaped busbar ≥ 2000A

2 x PFCB2025 + PFCC0023

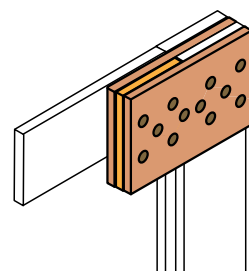
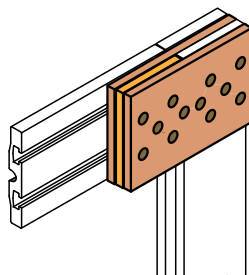

Flat busbars 3 for phase
Shaped busbar ≤ 1600A

PFCB4080 or PFCB1016 or PFCB2025 + PFCC0023

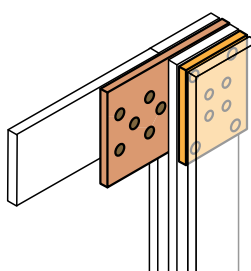
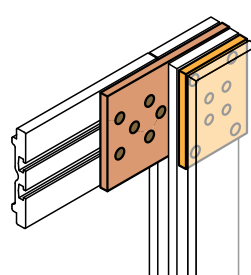

Flat busbars 3 for phase
Shaped busbar ≥ 2000A

2 x PFCB2025 + PFCC0023

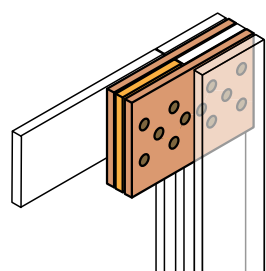
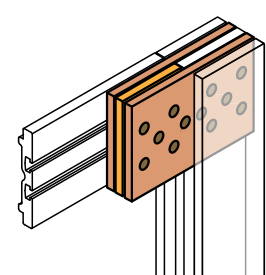

Examples of busbars junction

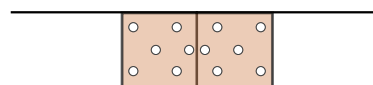
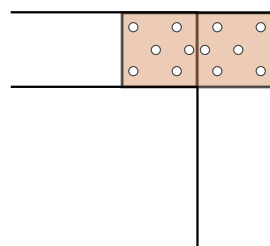
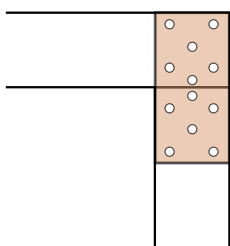

System pro E power

Selection guides

Flexible busbars up to 1250A







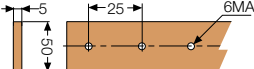
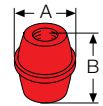



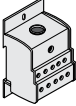

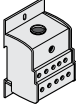
In (A)	Code	No. busbar/phase	Capacity (A)			Dimensions			
			IP31	IP41	IP65	WxW (mm)	Section dimensions (mm ²)	Lenght (mm)	Weight (kg)
160	PBFC0160	1			160	15.5x3	46.5	2000	
250	BF1602	1	395	323	250	20x3	60	2000	1,42
400	BF2502	1	498	460	400	20x5	100	2000	2,15
500	BF4002	1	660	620	500	24x6	144	2000	3
630	BF4012	1	758	702	630	32x5	160	2000	3,36
1000	BF6302	1	1203	1140	1000	40x8	320	2000	6,33
1250	BF8002	1	1515	1390	1250	50x10	500	2000	9,68

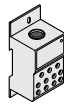
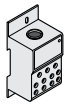
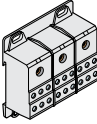
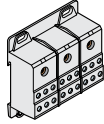
5

Flat drilled and threaded busbars for earthing connection

Cross-section	Code	Threading	Pitch (mm)	WxW (mm)	Lenght (mm)	AxB (mm)
	EV1119	6 MA	20	20x5	2000	
	EV1120	6 MA	20	25x5	2000	
	EV1121	6MA	25	50x5	2000	
	EV1122	6MA				34x30
	EV1123	8MA				34x30
	EV1124	6MA				40x50
	EV1125	8MA				40x50

Modular dividers

		Single-pole						Three-poles	
									
Code		AD1076	AD1080 ⁽¹⁾	AD1007	D1081 ⁽²⁾	AD1030	AD1031	AD1075	AD1006
In	IEC (A)	125	125	160	160	250	400	125	160
	UL (A)	115	115	175	160	230	310	115	175
Icw	(kA)	4.4	4.2	11	1.1	21	21	4.4	11
Version	pole	1	1	1	1	1	1	3	3
Installation		DIN35/plate	DIN35/plate	DIN35/plate	DIN35/plate	DIN35/plate	DIN35/plate	DIN35/plate	DIN35/plate
power supply Ø cable (mm ²)	min.	10	6	16	10	35	95	10	16
	max	35	35	70	70	120	185	35	70
No. outgoing feeder Ø cable (mm ²)	1,5÷10					4	4		
	2,5÷16	10	6	10	6	5	5	6	6
	2,5÷25					2	2		
Dimensions HxWxD	(mm)	71x45x42,5	74x27x47	71x45x42,5	92x35x49	95.5x45x49	95.5x45x49	71.5x80x42,5	71.5x80x42,5
No. DIN modules		2,5	1,5	2,5	2	3	3	4,5	4,5
Rated service voltage Ue	(V)	1000 Vac 1500 Vdc	1000 Vac 1500 Vdc	1000 Vac 1500 Vdc	1000 Vac 1500 Vdc	1000 Vac 1500 Vdc	1000 Vac 1500 Vdc	1000 Vac 1500 Vdc	1000 Vac 1500 Vdc
Degree of protection	IP	20	20	20	20	20	20	20	20
Mark									

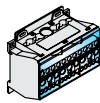
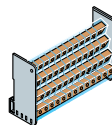
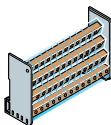
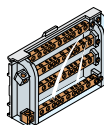
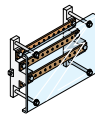
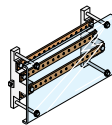
		Three-poles					
							
Code		AD1004	AD1028	AD1029	AD1027	AD1034	AD1053
In	(A)	125	125	125	160	250	250
Icw	(kA)	10	4.2	4.2	6.2	15	15
Ipk	(kA)	24	25	25	20	30	30
Version	poli	4.2	4	4	4	30	30
Installation		DIN35/plate	DIN35/plate	DIN35/plate	DIN35	4	4
power supply Ø cable (mm ²)	min.	6	6	6	10	with AD1038 brackets	with AD1038 brackets
	max	35	25 with cable terminal	25 with cable terminal	50		
No. outgoing feeder Ø cable (mm ²)	1/6 5/phase					No. 22 holes M5 with 17,5mm pitch per phase (threaded busb. 20x5mm)	No. 32 holes M5 with 17,5mm pitch per phase (threaded busb. 20x5mm)
	1.5/6 4/neutral						
	1.5/10 2/phase 6/neutral	7	9				
	1.5/16			2			
	2.5/16				8		
	6/25	2	2	3			
Dimensions HxWxD	(mm)	74.5x98x45	93x89x48	96x126x48	90x160.5x50	150x600x70	150x800x70
No. DIN modules		5,5	5	7	9	24	36
Rated service voltage Ue	(V)	1000 Vac 1500 Vdc	440	440	440	500	500
Degree of protection	IP	20	20	20	20		
Mark		UL	UL	UL	UL	UL	UL

⁽¹⁾ Possibility of putting in parallel with AD1083 connections.

⁽²⁾ Possibility of putting in parallel with comb type connection (not supplied).

System pro E power

Guide to the order codes

The new code is formed by 4 letters standing for English terms and 4 numbers, without spaces in between.

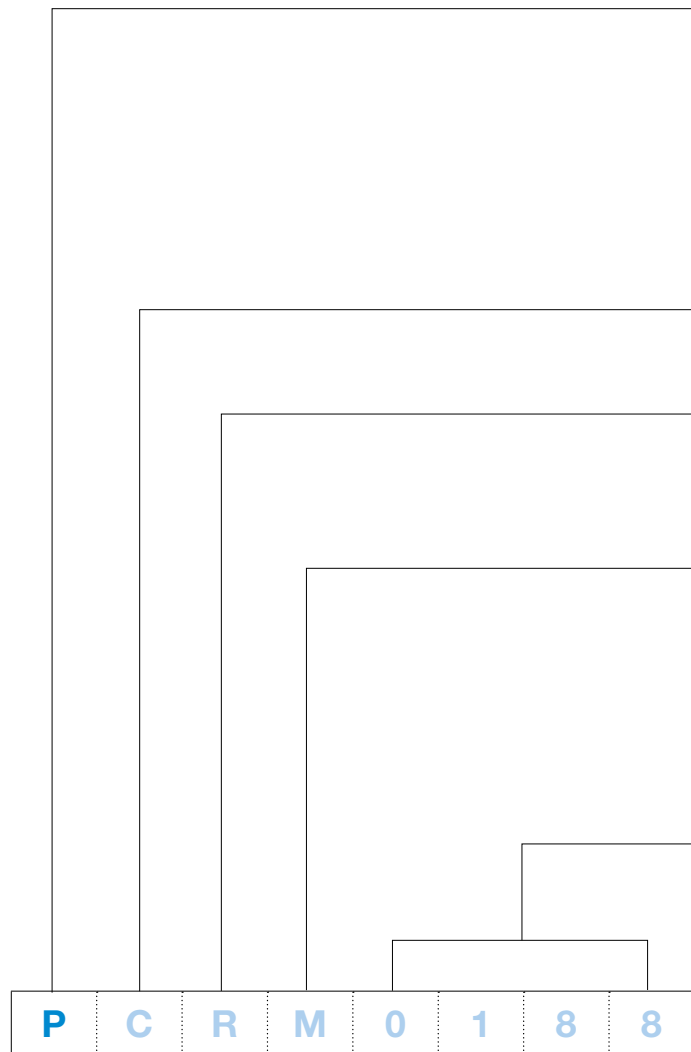

RANGE IDENTIFIER

The first letter of all the codes of the new main distribution switchboard "**P**" stands for "**power**". Thus the new product is clearly identified by the same initial used for all new components of ABB's System pro E power

TYPE OF PRODUCT AND CHARACTERISTICS

The second letter in the code indicates the type of product or component of the switchboard. The third and fourth letters describe the characteristics or material in more detail.

C = Crosspieces
B = Busbar holder, Busbar, Brackets
T = Tie rods

R = Crosspieces, Tie rods
H = Busbar holder
F = Flat
S = Shaped
B = Busbar, Bottom

M = Metal
S = Stainless steel
B = Linear
S = Scaled
N = Nylon
C = Copper
V = Vertical
H = Horizontal
T = Top

MEASUREMENTS

The last 4 numbers usually refer to a measurement of the component or several dimensions pertaining to the code.

System pro E power

Order codes - Distribution systems

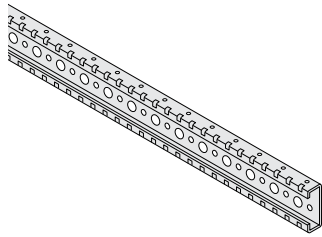

Crosspieces – Galvanized sheet metal

Crosspieces in 20/10 thick hot-dip galvanized sheet metal, for < than 4000A current values. They are fixed directly inside the cubicle using a purpose-made bracket to form busbar holders or as universal crosspieces.

Equipped with 12.5mm pitch rectangular holes, they are able to house insulating supports for thermoplastic busbar holders with snap-fit mechanism.

Description	Dimensions structure		Order code	ABB code	Package/ No.pcs
	D (mm)	W (mm)			
Depth galvanized sheet metal crosspieces for structures without intermediate upright					
No.2 crosspieces	200		PCRM0188	1STQ007375A0000	1/2
No.2 crosspieces	300		PCRM0288	1STQ007376A0000	1/2
No.2 crosspieces	500		PCRM0488	1STQ007378A0000	1/2
No.2 crosspieces	700		PCRM0688	1STQ007380A0000	1/2
No.2 crosspieces	900		PCRM0888	1STQ007382A0000	1/2
Depth galvanized sheet metal crosspieces for structures with intermediate upright or PCKI.... crosspieces					
No.2 crosspieces	500		PCRM0238	1STQ007384A0000	1/2
No.2 crosspieces	700		PCRM0438	1STQ007386A0000	1/2
No.2 crosspieces	900		PCRM0638	1STQ007388A0000	1/2
Width galvanized sheet metal crosspieces for structures with or without intermediate upright					
No.2 crosspieces		300	PCRM0288	1STQ007376A0000	1/2
No.2 crosspieces		400	PCRM0388	1STQ007377A0000	1/2
No.2 crosspieces		600	PCRM0588	1STQ007379A0000	1/2
No.2 crosspieces		800	PCRM0788	1STQ007381A0000	1/2
No.2 crosspieces		1000	PCRM0988	1STQ007383A0000	1/2
No.2 crosspieces		1250	PCRM1238	1STQ007390A0000	1/2
Universal crosspieces					
No.2 crosspieces L=2013mm			PCRM2013	1STQ007391A0000	1/2
Closing galvanized sheet metal crosspieces					
No.2 crosspieces			PCRM0188	1STQ007375A0000	1/2
No.2 crosspieces			PCRM0238	1STQ007384A0000	1/2
No.2 crosspieces			PCRM0288	1STQ007376A0000	1/2
No.2 crosspieces			PCRM0338	1STQ007385A0000	1/2
No.2 crosspieces			PCRM0438	1STQ007386A0000	1/2
No.2 crosspieces			PCRM0538	1STQ007387A0000	1/2
No.2 crosspieces			PCRM0738	1STQ007389A0000	1/2

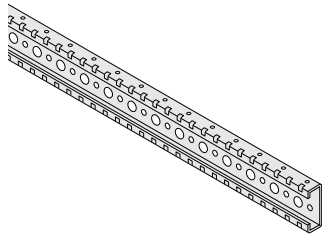

Crosspieces – AISI 304 stainless steel

Crosspieces in 25/10 thick AISI 304 stainless steel for \geq than 4000A current values. They are fixed directly inside the cubicle using a purpose-made bracket to form busbar holders or as universal crosspieces.

Equipped with 12.5mm pitch rectangular holes, they are able to house insulating supports for thermoplastic busbar holders with snap-fit mechanism. Since the components are modular, the center distance between the phases can be increased by spacing the insulating supports at a 12.5mm pitch.

Description	Dimensions structure		Order code	ABB code	Package/ No.pcs
	D (mm)	W (mm)			
Depth stainless steel crosspieces for structures without intermediate upright					
No. 2 crosspieces	900		PCRS0888	1STQ007395A0000	1/2
Depth stainless steel crosspieces for structures with intermediate upright or PCKI.... crosspieces					
No. 2 crosspieces	700		PCRS0438	1STQ007398A0000	1/2
No. 2 crosspieces	900		PCRS0638	1STQ007399A0000	1/2
Width stainless steel crosspieces for structures with or without intermediate upright					
No. 2 crosspieces		400	PCRS0388	1STQ007392A0000	1/2
No. 2 crosspieces		600	PCRS0588	1STQ007393A0000	1/2
No. 2 crosspieces		800	PCRS0788	1STQ007394A0000	1/2
No. 2 crosspieces		1000	PCRS0988	1STQ007396A0000	1/2
No. 2 crosspieces		1250	PCRS1238	1STQ007400A0000	1/2
Closing stainless steel crosspieces					
No. 2 crosspieces			PCRS0338	1STQ007397A0000	1/2
No. 2 crosspieces			PCRS0438	1STQ007398A0000	1/2
Universal crosspieces					
No. 2 crosspieces L=2013mm			PCRS2013		1/2

5

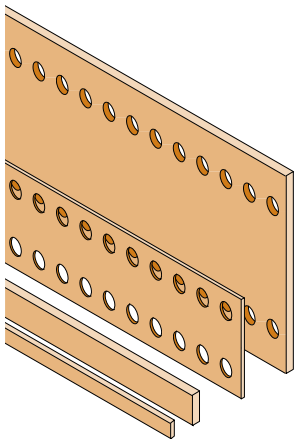

Flat copper busbars

Flat busbars Lenght =1750mm.

Description	WxW (mm)	No. row drillings	Ø drilling (mm)	Order code	ABB code	Package/ No.pcs
Flat copper busbar	20x5	1	6.5	PBFC2005	1STQ007401A0000	1/1
Flat copper busbar	25x5	1	6.5	PBFC2505	1STQ007402A0000	1/1
Flat copper busbar	32x5	1	6.5	PBFC3205	1STQ007403A0000	1/1
Flat copper busbar	40x5	1	6.5	PBFC4005	1STQ007404A0000	1/1
Flat copper busbar	50x5	2	10.5	PBFC5005	1STQ007405A0000	1/1
Flat copper busbar	63x5	2	10.5	PBFC6305	1STQ007406A0000	1/1
Flat copper busbar	80x5	2	10.5	PBFC8005	1STQ007407A0000	1/1
Flat copper busbar	100x5	2	10.5	PBFC1005	1STQ007408A0000	1/1
Flat copper busbar	30x10	2	10.5	PBFC3010	1STQ007409A0000	1/1
Flat copper busbar	40x10	-	-	PBFC4010	1STQ007410A0000	1/1
Flat copper busbar	50x10	-	-	PBFC5010	1STQ007411A0000	1/1
Flat copper busbar	60x10	-	-	PBFC6010	1STQ007412A0000	1/1
Flat copper busbar	80x10	-	-	PBFC8010	1STQ007413A0000	1/1
Flat copper busbar	100x10	-	-	PBFC1001	1STQ007414A0000	1/1
Flat copper busbar	120x10	-	-	PBFC1201	1STQ007415A0000	1/1
Flat copper busbar	160x10	-	-	PBFC1601	1STQ007416A0000	1/1
Flat copper busbar	200x10	-	-	PBFC2001	1STQ007417A0000	1/1

System pro E power

Order codes - Distribution systems

5

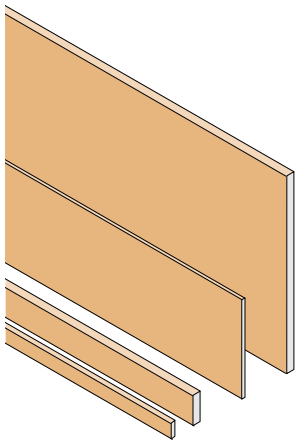

Flat busbars in Cuponal

Flat busbars in Cuponal (co-extruded copper-clad aluminium busbars) for In up to 3200A.

Description	WxW (mm)	Lenght (mm)	Order code	ABB code	Package/ No.pcs
Flat busbars in Cuponal	20x5	1750	PBFA2005	1STQ009187A0000	1/1
Flat busbars in Cuponal	25x5	1750	PBFA2505	1STQ009188A0000	1/1
Flat busbars in Cuponal	30x5	1750	PBFA3005	1STQ009189A0000	1/1
Flat busbars in Cuponal	40x5	1750	PBFA4005	1STQ009190A0000	1/1
Flat busbars in Cuponal	50x5	1750	PBFA5005	1STQ009191A0000	1/1
Flat busbars in Cuponal	60x5	1750	PBFA6005	1STQ009192A0000	1/1
Flat busbars in Cuponal	80x5	1750	PBFA8005	1STQ009193A0000	1/1
Flat busbars in Cuponal	40x10	1750	PBFA4010	1STQ009194A0000	1/1
Flat busbars in Cuponal	50x10	1750	PBFA5010	1STQ009195A0000	1/1
Flat busbars in Cuponal	75x10	1750	PBFA7510	1STQ009196A0000	1/1
Flat busbars in Cuponal	80x10	1750	PBFA8010	1STQ009197A0000	1/1
Flat busbars in Cuponal	100x10	1750	PBFA1001	1STQ009198A0000	1/1
Flat busbars in Cuponal	120x10	1750	PBFA1201	1STQ009199A0000	1/1

Shaped profile copper busbar

Shaped profile distribution busbars L=1750mm.

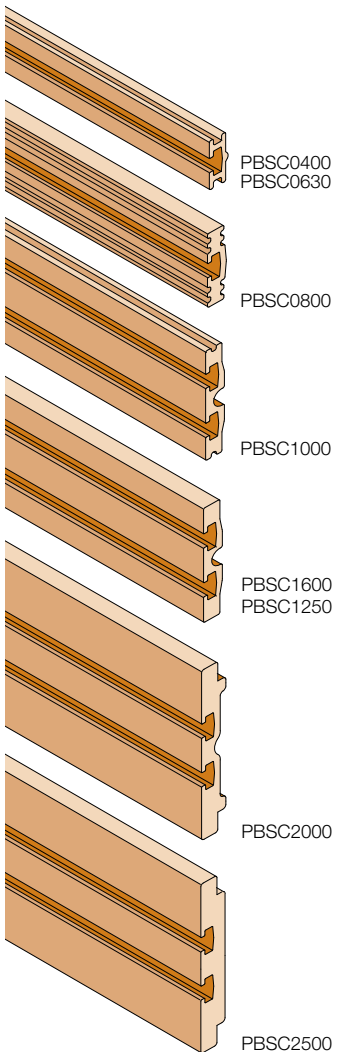

Description	WxW (mm)	Section mm ²	Lenght (mm)	Order code	ABB code	Package/ No.pcs
Shaped copper busbar	30x10	165	1750	PBSC0400	1STQ007418A0000	1/1
Shaped copper busbar	35x10	204	1750	PBSC0630	1STQ007419A0000	1/1
Shaped copper busbar	45x10	324	1750	PBSC0800	1STQ007420A0000	1/1
Shaped copper busbar	67x10	454	1750	PBSC1000	1STQ007421A0000	1/1
Shaped copper busbar	70x10	516	1750	PBSC1250	1STQ007422A0000	1/1
Shaped copper busbar	95x10	758	1750	PBSC1600	1STQ007423A0000	1/1
Shaped copper busbar	105x15	995	1750	PBSC2000	1STQ007424A0000	1/1
Shaped copper busbar	105x15	1255	1750	PBSC2500	1STQ007425A0000	1/1

> Quick selection guides page 5/6 > Technical details page 7/1 > Overall dimensions page 8/1

Connections D=300mm for not accessorized fixed breakers (front terminals)

LINEAR BUSBAR HOLDER, SHAPED BUSBARS 1600A IN CABLE CONTAINER

For horizontal fixed breakers 3 P is necessary to use the relating 3/4 P mounting kit in order to assemble the connections. The busbar system must be build up with insulators W=50mm (PBHB1125). The busbars must be mounted into the most rear and farther position from the circuit breaker with the neutral in the first position towards the front (see picture). Use brackets PBBV008 for fixing the busbar system. The code includes an insulator mounted on the plate.

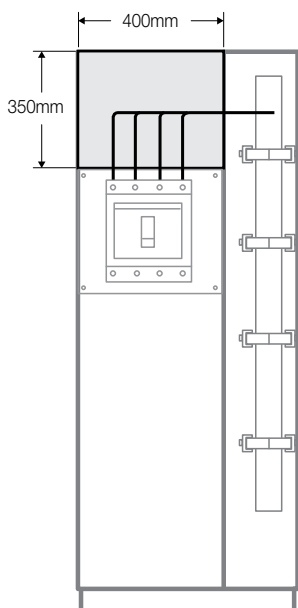
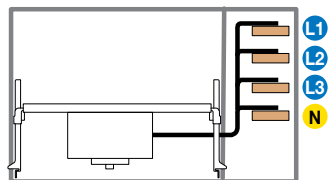
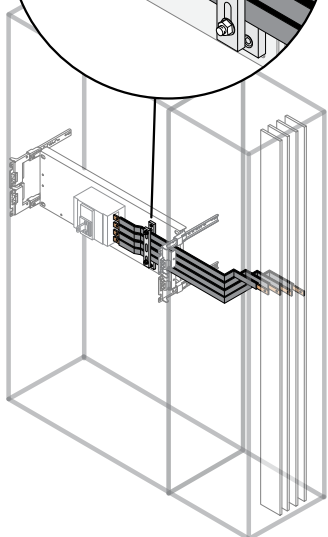
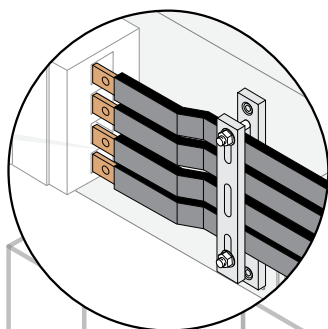

Circuit-breakers	No. poles	In (A)	Structure width (mm)		Order code	ABB code	Package/No.pcs
			External cable container W=300mm	Internal cable container W=400mm			
Horizontal instillation							
XT1	3P	160A	400	800	PBPX1631	1STQ009229A0000	1/1
XT1	3P	160A	600	1000	PBTX1631	1STQ009230A0000	1/1
XT1	4P	160A	400	800	PDPX1631	1STQ009231A0000	1/1
XT1	4P	160A	600	1000	PDTX1631	1STQ009232A0000	1/1
XT2	3P	160A	400	800	PBPX2631	1STQ009233A0000	1/1
XT2	3P	160A	600	1000	PBTX2631	1STQ009234A0000	1/1
XT2	4P	160A	400	800	PDPX2631	1STQ009235A0000	1/1
XT2	4P	160A	600	1000	PDTX2631	1STQ009236A0000	1/1
XT3	3P	250A	400	800	PBPX3631	1STQ009237A0000	1/1
XT3	3P	250A	600	1000	PBTX3631	1STQ009238A0000	1/1
XT3	4P	250A	400	800	PDPX3631	1STQ009239A0000	1/1
XT3	4P	250A	600	1000	PDTX3631	1STQ009240A0000	1/1
XT4	3P	250A	400	800	PBPX4631	1STQ009241A0000	1/1
XT4	3P	250A	600	1000	PBTX4631	1STQ009242A0000	1/1
XT4	4P	250A	400	800	PDPX4631	1STQ009243A0000	1/1
XT4	4P	250A	600	1000	PDTX4631	1STQ009244A0000	1/1
T4	3P	320A	400	800	PBPT4631	1STQ009245A0000	1/1
T4	3P	320A	600	1000	PBTT4631	1STQ009246A0000	1/1
T4	4P	320A	400	800	PDPT4631	1STQ009247A0000	1/1
T4	4P	320A	600	1000	PDTT4631	1STQ009248A0000	1/1
T5	3P	400A	400	800	PBPT5631	1STQ009249A0000	1/1
T5	3P	400A	600	1000	PBTT5631	1STQ009250A0000	1/1
T5	4P	400A	400	800	PDPT5631	1STQ009251A0000	1/1
T5	4P	400A	600	1000	PDTT5631	1STQ009252A0000	1/1
T6	3P	800A	600	1000	PBTT6631	1STQ009253A0000	1/1
T6	4P	800A	600	1000	PDTT6631	1STQ009254A0000	1/1
T7	3P	1600A	600	1000	PBTT7631	1STQ009255A0000	1/1
T7	4P	1600A	600	1000	PDTT7631	1STQ009256A0000	1/1
E1.2	3P	1600A	600	1000	PBTT7631	1STQ009255A0000	1/1
E1.2	4P	1600A	600	1000	PDTT7631	1STQ009256A0000	1/1
Vertical instillation							
T6 ⁽¹⁾	3P	800A	600	1000	PCTT6631	1STQ009259A0000	1/1
T6 ⁽¹⁾	4P	800A	600	1000	PFTT6631	1STQ009260A0000	1/1
T7 ⁽²⁾	3P	1600A	600	1000	PCTT7631	1STQ009261A0000	1/1
T7 ⁽²⁾	4P	1600A	600	1000	PFTT7631	1STQ009262A0000	1/1
E1.2 ⁽²⁾	3P	1600A	600	1000	PCTT7631	1STQ009261A0000	1/1
E1.2 ⁽²⁾	4P	1600A	600	1000	PFTT7631	1STQ009262A0000	1/1

⁽¹⁾ For vertical T6 breakers it is necessary to leave a blind cell above H=200mm.

⁽²⁾ For vertical T7 and E1.2 it is necessary to leave a blind cell above H=350mm. The connections are designed for the high side of the circuit breakers with busbars to the right.

System pro E power

Order codes - Distribution systems

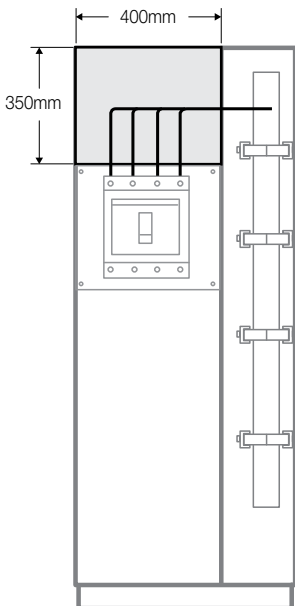
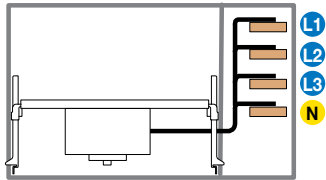
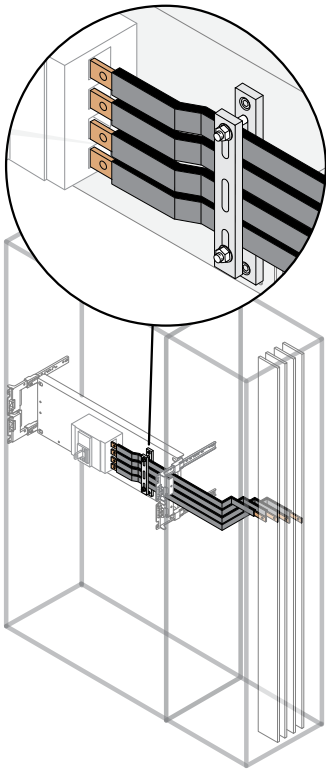

Connections D=300mm for not accessorized fixed breakers (front terminals)

LINEAR BUSBAR HOLDER, SHAPED BUSBARS 800A IN INTERNAL CABLE CONTAINER W=200mm

For horizontal fixed breakers 3 P is necessary to use the relating 3/4 P mounting kit in order to assemble the connections. The busbars must be mounted into the most rear and farther position from the circuit breaker with the neutral in the first position towards the front (see picture). Use brackets PBBV008 for fixing the busbar system. The code includes an insulator mounted on the plate.

Circuit-breakers	No. poles	In (A)	Structure width (mm)	Order code	ABB code	Package/ No.pcs
Horizontal instillation - Shaped busbars 800A						
XT1	3P	160A	600	PBGX1738	1STQ008663A0000	1/1
XT1	3P	160A	800	PBPX1738	1STQ009265A0000	1/1
XT1	4P	160A	600	PDGX1738	1STQ008664A0000	1/1
XT1	4P	160A	800	PDPX1738	1STQ009266A0000	1/1
XT2	3P	160A	600	PBGX2738	1STQ008667A0000	1/1
XT2	3P	160A	800	PBPX2738	1STQ009267A0000	1/1
XT2	4P	160A	600	PDGX2738	1STQ008668A0000	1/1
XT2	4P	160A	800	PDPX2738	1STQ009268A0000	1/1
XT3	3P	250A	600	PBGX3738	1STQ008671A0000	1/1
XT3	3P	250A	800	PBPX3738	1STQ009269A0000	1/1
XT3	4P	250A	600	PDGX3738	1STQ008672A0000	1/1
XT3	4P	250A	800	PDPX3738	1STQ009270A0000	1/1
XT4	3P	250A	600	PBGX4738	1STQ008675A0000	1/1
XT4	3P	250A	800	PBPX4738	1STQ009271A0000	1/1
XT4	4P	250A	600	PDGX4738	1STQ008676A0000	1/1
XT4	4P	250A	800	PDPX4738	1STQ009272A0000	1/1
T4	3P	320A	600	PBGT4738	1STQ008679A0000	1/1
T4	3P	320A	800	PBPT4738	1STQ009273A0000	1/1
T4	4P	320A	600	PDGT4738	1STQ008680A0000	1/1
T4	4P	320A	800	PDPT4738	1STQ009274A0000	1/1
T5	3P	400A	600	PBGT5738	1STQ008683A0000	1/1
T5	3P	400A	800	PBPT5738	1STQ009275A0000	1/1
T5	4P	400A	600	PDGT5738	1STQ008684A0000	1/1
T5	4P	400A	800	PDPT5738	1STQ009276A0000	1/1
T6	3P	800A	800	PBPT6738	1STQ009277A0000	1/1
T6	4P	800A	800	PDPT6738	1STQ009278A0000	1/1
Vertical instillation - Shaped busbars 800A						
T6 ⁽¹⁾	3P	800A	800	PCPT6738	1STQ009279A0000	1/1
T6 ⁽¹⁾	4P	800A	800	PFPT6738	1STQ009280A0000	1/1

⁽¹⁾ For vertical T6 breakers it is necessary to leave a blind cell above H=200mm.

Insulator for connections

Description	Order code	ABB code	Package/ No.pcs
Horizontal insulator for XT1-XT2-XT3-XT4-T4	PITH1234	1STQ001474B0000	1/1
Horizontal insulator for T5	PITH5000	1STQ001475B0000	1/1
Horizontal insulator for T6	PITH6000	1STQ001476B0000	1/1
Vertical insulator for T6	PITV6000	1STQ001477B0000	1/1
Horizontal/Vertical insulator for T7-E1.2	PITE7120	1STQ001478B0000	1/1

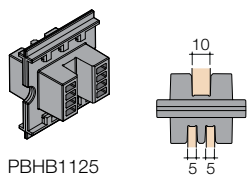

PBHB1125

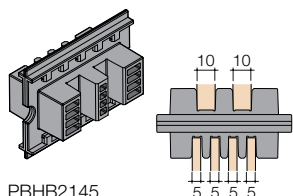

PBHB2145

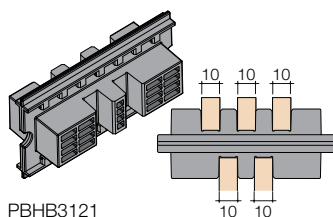

PBHB3121

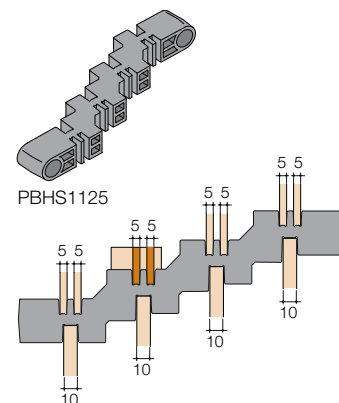

PBHS1125

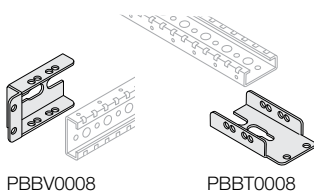

PBBV0008

PBBT0008

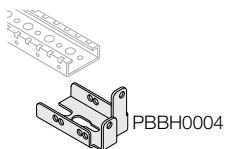

PBBH0004

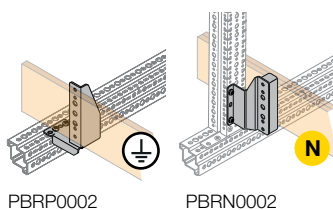

PBRP0002

PBRN0002

Insulating supports for busbars

Insulating supports for busbars in polyamide 6.6 with 30% fiberglass, equipped with shaped grooves for housing busbars and pins for fixing to the crosspieces. Able to house both flat and shaped profile busbars.

Description	Dimensions W (mm)	Order code	ABB code	Package/ No.pcs
No.24 insulating supports for busbars	50	PBHB1125	1STQ007426A0000	1/24
No.24 insulating supports for busbars	75	PBHB2145	1STQ007427A0000	1/24
No.24 insulating supports for busbars	100	PBHB3121	1STQ007428A0000	1/24

Scaled busbar holder

Scaled busbar holder for flat-shaped busbars complete with spacer and nylon tie rods.

Description	Order code	ABB code	Package/ No.pcs
Scaled busbar holder	PBHS1125	1STQ007429A0000	1/1

Crosspiece fixing brackets.

Description	Order code	ABB code	Package/ No.pcs
No. 8 brackets for crosspieces - vertical side	PBBV0008	1STQ007430A0000	1/8
No. 4 brackets for crosspieces at all heights	PBBH0004	1STQ007431A0000	1/4
No. 8 brackets for top-bottom-side crosspieces	PBBT0008	1STQ007432A0000	1/8
No. 2 busbar backing brackets for corner structure	PBCB0002	1STQ009186A0000	1/2

Brackets for earth and neutral fixing

Description	Order code	ABB code	Package/ No.pcs
No. 2 brackets for earth fixing	PBRP0002	1STQ001554B0000	1/2
No. 2 brackets for neutral fixing	PBRN0002	1STQ001555B0000	1/2

System pro E power

Order codes - Distribution systems

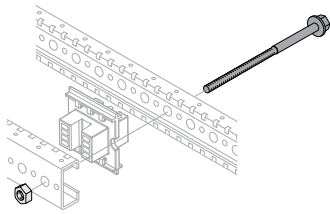

Nylon tie rods

Nylon tie rods (thermoplastic material for $I_n < 4000A$ current values).

Description	Order code	ABB code	Package/ No.pcs
No.10 nylon tie rods L=195mm <4000A	PTRN1951	1STQ007433A0000	1/10

Tie rods in AISI 304 stainless steel

Tie rods in AISI 304 stainless steel (for $I_n \geq 4000A$ current values).

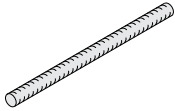

Description	Order code	ABB code	Package/ No.pcs
No. 10 Tie rods in AISI 304 stainless steel W=120mm	PTRS1201	1STQ007434A0000	1/10
No. 10 Tie rods in AISI 304 stainless steel W=160mm	PTRS1601	1STQ007435A0000	1/10
No. 10 Tie rods in AISI 304 stainless steel W=200mm	PTRS2001	1STQ007436A0000	1/10

5



Crosspiece for horizontal busbar assembly under top or on bottom of structure

For assembly in $D > 300mm$ structures with internal cable compartment, order PCCM.... cable compartment depth crosspieces as well.

Description	Dimensions W (mm)	Order code	ABB code	Package/ No.pcs
Intermediate crosspiece for busbars under top/on bottom	300	PCKI0300	1STQ008099A0000	1/1
Intermediate crosspiece for busbars under top/on bottom	400	PCKI0400	1STQ008100A0000	1/1
Intermediate crosspiece for busbars under top/on bottom	600	PCKI0600	1STQ008101A0000	1/1
Intermediate crosspiece for busbars under top/on bottom	800	PCKI0800	1STQ008102A0000	1/1
Intermediate crosspiece for busbars under top/on bottom	1000	PCKI1000	1STQ008103A0000	1/1
Intermediate crosspiece for busbars under top/on bottom	1250	PCKI1250	1STQ008104A0000	1/1

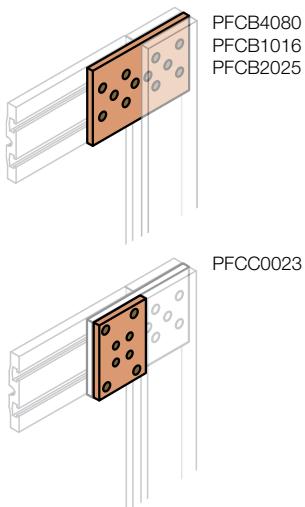

Compensators and connections for flat and shaped busbar

Description	Order code	ABB code	Package/ No.pcs
Connections between shaped busbar/shaped busbar or shaped busbar/flat busbar for 400A, 630A, 800A	PFCB4080	1STQ009224A0000	1/1
Connections between shaped busbar/shaped busbar or shaped busbar/flat busbar for 1000A, 1250A, 1600A	PFCB1016	1STQ009225A0000	1/1
Connections between shaped busbar/shaped busbar or shaped busbar/flat busbar for 2000A, 2500A	PFCB2025	1STQ009226A0000	1/1
Compensator for configurations compose of no. of busbar per phase > 1	PFCC0023	1STQ009227A0000	1/1

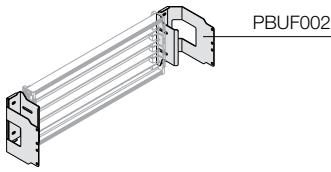

PBUF002

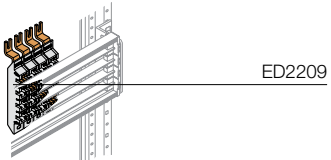

ED2209

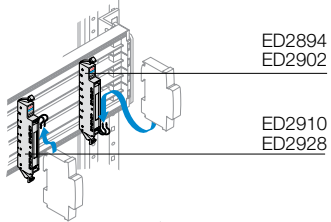

ED2894
ED2902

ED2910
ED2928

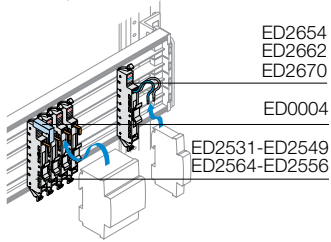

ED2654
ED2662
ED2670

ED0004

ED2531-ED2549
ED2564-ED2556

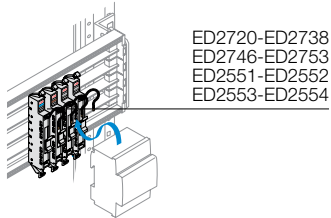

ED2720-ED2738
ED2746-ED2753
ED2551-ED2552
ED2553-ED2554

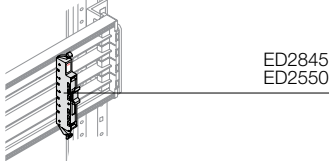

ED2845
ED2550

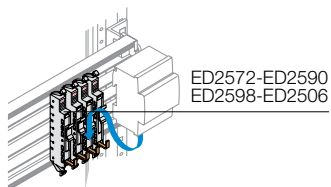

ED2572-ED2590
ED2598-ED2506

Unifix H

Description	Dimensions (mm) W	Order code	ABB code	Package/ No. pcs
No.2 brackets for fixing Unifix to structure		PBUF0002	1STQ008117A0000	1/2
Frames for Tmax and modular circuit-breakers - System pro M				
Frames with 24 busbars DIN modules	600	ED2183	1STQ008228A0000	1/1
Frames with 36 busbars DIN modules	800	ED2191	1STQ008229A0000	1/1
Feeder modules				
4P 400A feeder module (for ED2183-ED2191)		ED2209	1STQ008230A0000	1/1
Basic module I_n 16A				
Basic module for auxiliaries DIN L1-N high 16A		ED2894	1STQ008255A0000	1/1
Basic module for auxiliaries DIN L1-L2 high 16A		ED2902	1STQ008256A0000	1/1
Basic module for auxiliaries DIN L1-N low 16A		ED2910	1STQ008257A0000	1/1
Basic module for auxiliaries DIN L1-L2 low 16A		ED2928	1STQ008258A0000	1/1
Basic module I_n 40A				
Basic module L1/Neutral high 40A		ED2654	1STQ008248A0000	1/1
Basic module L2/Neutral high 40A		ED2662	1STQ008249A0000	1/1
Basic module L3/Neutral high 40A		ED2670	1STQ008250A0000	1/1
Basic module I_n 63A				
Basic module L1 high 63A		ED2531	1STQ008231A0000	1/1
Basic module L2 high 63A		ED2549	1STQ008232A0000	1/1
Basic module L3 high 63A		ED2556	1STQ008238A0000	1/1
Basic module Neutral high 63A		ED2564	1STQ008243A0000	1/1
Basic module L1 low 63A		ED2572	1STQ008244A0000	1/1
Basic module L2 low 63A		ED2590	1STQ008245A0000	1/1
Basic module L3 low 63A		ED2598	1STQ008246A0000	1/1
Basic module Neutral low 63A		ED2606	1STQ008247A0000	1/1
Basic module I_n 100A				
Basic module with cable L1 high 100A		ED2720	1STQ008251A0000	1/1
Basic module with cable L2 high 100A		ED2738	1STQ008252A0000	1/1
Basic module with cable L3 high 100A		ED2746	1STQ008253A0000	1/1
Basic module with Neutral cable high 100A		ED2753	1STQ008254A0000	1/1
Basic modules ≤ I_n 40A S800				
Basic module L1 high ≤40A		ED2557	1STQ008239A0000	1/1
Basic module L2 high ≤40A		ED2558	1STQ008240A0000	1/1
Basic module L3 high ≤40A		ED2559	1STQ008241A0000	1/1
Basic module Neutral high ≤40A		ED2560	1STQ008242A0000	1/1
Basic modules ≤ I_n 125A S800				
Basic module L1 high 125A		ED2551	1STQ008234A0000	1/1
Basic module L2 high 125A		ED2552	1STQ008235A0000	1/1
Basic module L3 high 125A		ED2553	1STQ008236A0000	1/1
Basic module Neutral high 125A		ED2554	1STQ008237A0000	1/1
Basic module pole blank L=27mm		ED2550	1STQ008233A0000	1/1

System pro E power

Order codes - Distribution systems

5

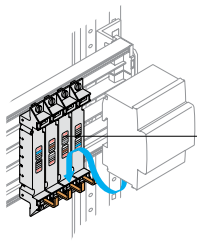

ED2217-ED2225
ED2233-ED2241
ED2258-ED2266
ED2274-ED2282
ED2332-ED2340
ED2357-ED2365

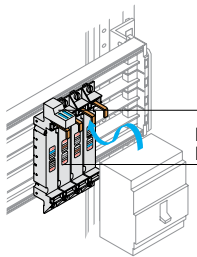

ED0001
ED0002
ED0003

ED2290-ED2308
ED2316-ED2324

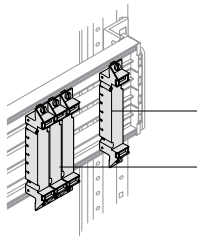

ED2373

ED2381
ED2399

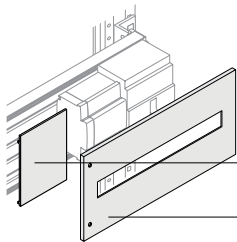

ED2407

PPMU3060
PPMU3080

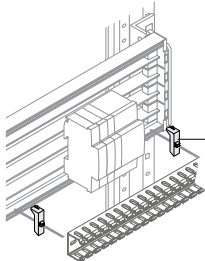

ED2936

Unifix H

Description	Order code	ABB code	Package/ No. pcs
Basic modules $\leq I_n$ 160A Tmax XT1 (front terminals FCCuAl)			
Basic module L1 high L2 low	ED2217	1STQ008263A0000	1/1
Basic module L2 high L1 low	ED2225	1STQ008264A0000	1/1
Basic module L3 high Neutral low	ED2233	1STQ008265A0000	1/1
Basic module Neutral high L3 low	ED2241	1STQ008266A0000	1/1
Basic module pole blank for RC221 residual current release	ED2373	1STQ008279A0000	1/1
Basic module pole blank for solenoid operating mechanism	ED2381	1STQ008280A0000	1/1
Basic modules $\leq I_n$ 160A Tmax T2			
Basic module L1 high L2 low	ED2258	1STQ008267A0000	1/1
Basic module L2 high L1 low	ED2266	1STQ008268A0000	1/1
Basic module L3 high N low	ED2274	1STQ008269A0000	1/1
Basic module N high L3 low	ED2282	1STQ008270A0000	1/1
Basic module pole blank for RC221 residual current release	ED2373	1STQ008279A0000	1/1
Basic module pole blank for solenoid operating mechanism	ED2399	1STQ008281A0000	1/1
Basic modules $\leq I_n$ 250A Tmax XT3			
Basic module L1 high	ED2290	1STQ008271A0000	1/1
Basic module L2 high	ED2308	1STQ008272A0000	1/1
Basic module L3 high	ED2316	1STQ008273A0000	1/1
Basic module N high	ED2324	1STQ008274A0000	1/1
Basic module L1 low	ED2332	1STQ008275A0000	1/1
Basic module L2 low	ED2340	1STQ008276A0000	1/1
Basic module L3 low	ED2357	1STQ008277A0000	1/1
Basic module N low	ED2365	1STQ008278A0000	1/1
Basic module pole blank for RC221 residual current release	ED2373	1STQ008279A0000	1/1
Accessories			
Basic module pole blank for DDA W=17.5mm	ED2845	1STQ008283A0000	1/1
Basic module pole blank for MDRC modular units	ED2852	1STQ008284A0000	1/1
2 IP20 covers (for ED2183-ED2191) W=173mm (10 DIN mod.)	ED2407	1STQ008282A0000	1/2
6 duct supports 40x60mm (only with modular apparatus)	ED2936	1STQ008285A0000	1/6
Modular front panel 300x600mm (HxW)	PPMU3060	1STQ008299A0000	1/1
Modular front panel 300x800mm (HxW)	PPMU3080	1STQ008300A0000	1/1
Spare parts			
10 terminal covers for T1	ED0001	1STQ008259A0000	1/10
10 terminal covers for T2	ED0002	1STQ008260A0000	1/10
10 terminal covers for T3	ED0003	1STQ008261A0000	1/10
10 terminal covers for S200/F200	ED0004	1STQ008262A0000	1/10

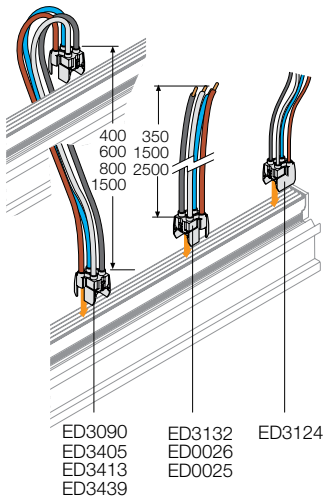
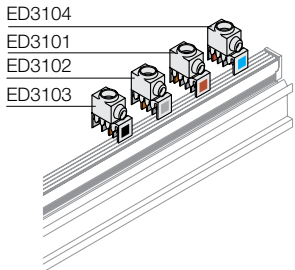
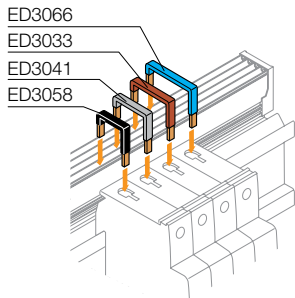
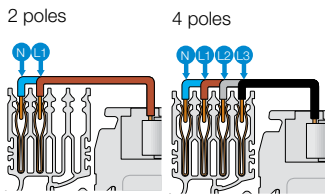

Unifix L

Description	Dimensions W (mm)	Order code	ABB code	Package/ No.pcs
2 brackets for fixing Unifix to structure		PBUF0002	1STQ008117A0000	1/2
2-pole busbars				
100A 2P busbar 8 modules	200	ED2985	1STQ008313A0000	1/6
100A 2P busbar 12 modules	400	ED2993	1STQ008314A0000	1/6
100A 2P busbar 18 modules	450	ED3009	1STQ008315A0000	1/6
100A 2P busbar 24 modules	600	ED3017	1STQ008316A0000	1/6
100A 2P busbar 36 modules	800	ED3025	1STQ008317A0000	1/6
4-pole busbars				
100A 4P busbar 12 modules	400	ED2944	1STQ008307A0000	1/6
100A 4P busbar 18 modules	450	ED2951	1STQ008308A0000	1/6
100A 4P busbar 24 modules	600	ED2969	1STQ008311A0000	1/6
100A 4P busbar 36 modules	800	ED2977	1STQ008312A0000	1/6
Connections for various equipment				
Connection with 2 conductors L1/N 16A		ED3108	1STQ008332A0000	1/6
Connection with 3 conductors L1/L2/L3 16A		ED3116	1STQ008333A0000	1/6
Connection with 4 conductors L1/L2/L3/ 16A single-phase		ED3124	1STQ008334A0000	1/6
Connection with 2 conductors L1/N 40A		ED3355	1STQ008339A0000	1/6
Connection with 3 conductors L1/L2/L3 40A		ED3363	1STQ008340A0000	1/6
Connection with 4 conductors L1/L2/L3/N 40A		ED3371	1STQ008341A0000	1/6
Connections for apparatuses				
Connections L1-N 40 A		ED3272	1STQ008336A0000	1/10
Connections L2-N 40 A		ED3280	1STQ008337A0000	1/10
Connections L3-N 40 A		ED3298	1STQ008338A0000	1/10
Connections L 1 100A		ED3033	1STQ008318A0000	1/10
Connections L 2 100A		ED3041	1STQ008319A0000	1/10
Connections L 3 100A		ED3058	1STQ008320A0000	1/10
Connections N 100A		ED3066	1STQ008321A0000	1/10
Feeder with cable 4P 100A (L=350mm)		ED3132	1STQ008335A0000	1/10
Feeder with cable 4P 100A (L=1500mm)		ED0026	1STQ008306A0000	1/10
Feeder with cable 4P 100A (L=2500mm)		ED0025	1STQ008305A0000	1/10
Feeder module with cable				
2P 100A parallel module with cable (L=600mm)		ED3082	1STQ008322A0000	1/6
4P 100A parallel module with cable (L=400mm)		ED3405	1STQ008342A0000	1/6
4P 100A parallel module with cable (L=600mm)		ED3090	1STQ008323A0000	1/6
4P 100A parallel module with cable (L=800mm)		ED3413	1STQ008343A0000	1/6
4P 100A parallel module with cable (L=1500mm)		ED3439	1STQ008344A0000	1/6
Feeder module without cable In 100A				
Single-pole feeder modules L 1		ED3101	1STQ008324A0000	1/10
Single-pole feeder modules L 2		ED3102	1STQ008326A0000	1/10
Single-pole feeder modules L 3		ED3103	1STQ008328A0000	1/10
Single-pole feeder modules N		ED3104	1STQ008330A0000	1/10
Accessories				
10 busbar covers (L=600mm)		ED2961	1STQ008309A0000	1/10
2 busbar covers (L=800mm)		ED2962	1STQ008310A0000	1/2

System pro E power

Order codes - Accessories

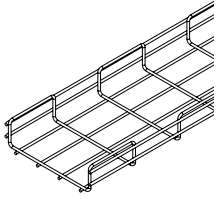

Rack rails in painted Sendzimir steel wire L=3000mm

Description	Order code	ABB code	Pack./meters
H=35mm			
Basic straight rack rails 75mm	1SL9816A00	1SL9816A00	24
Basic straight rack rails 100mm	1SL9817A00	1SL9817A00	24
Basic straight rack rails 150mm	1SL9818A00	1SL9818A00	24
Basic straight rack rails 200mm	1SL9819A00	1SL9819A00	12
Basic straight rack rails 300mm	1SL9820A00	1SL9820A00	12
H=50mm			
Basic straight rack rails 75mm	1SL9836A00	1SL9836A00	24
Basic straight rack rails 100mm	1SL9037A00	1SL9037A00	24
Basic straight rack rails 150mm	1SL9838A00	1SL9838A00	24
Basic straight rack rails 200mm	1SL9839A00	1SL9839A00	12
Basic straight rack rails 300mm	1SL9840A00	1SL9840A00	12
Basic straight rack rails 400mm	1SL9841A00	1SL9841A00	6
Basic straight rack rails 500mm	1SL9842A00	1SL9842A00	6
H=75mm			
Basic straight rack rails 75mm	1SL9860A00	1SL9860A00	24
Basic straight rack rails 100mm	1SL9861A00	1SL9861A00	24
Basic straight rack rails 150mm	1SL9862A00	1SL9862A00	24
Basic straight rack rails 200mm	1SL9863A00	1SL9863A00	12
Basic straight rack rails 300mm	1SL9864A00	1SL9864A00	12
Basic straight rack rails 400mm	1SL9865A00	1SL9865A00	6
Basic straight rack rails 500mm	1SL9866A00	1SL9866A00	6

5

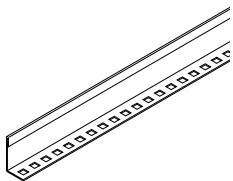

Straight separator profiles in Sendzimir

Description	Order code	ABB code	Package/No.pcs
L 2000mm separator profiles for rack rails H 35mm	1SL9904A00	1SL9904A00	1/20
L 2000mm separator profiles for rack rails H 50mm	06652	06652	1/20
L 2000mm separator profiles for rack rails H 75mm	07855	07855	1/20

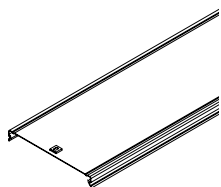

Covers in Sendzimir L=3000mm

Description	Order code	ABB code	Pack./meters
Basic straight cover 75mm	07241	07241	24
Basic straight cover 100mm	07242	07242	24
Basic straight cover 150mm	07243	07243	24
Basic straight cover 200mm	07244	07244	12
Basic straight cover 300mm	07245	07245	12
Basic straight cover 400mm	07246	07246	6
Basic straight cover 500mm	07247	07247	6

1SL9907A00-1SL9886A0
1SL9887A000

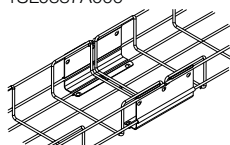

Accessories in Sendzimir

Description	Order code	ABB code	Package/No.pcs
Linear coupling	1SL9880A00	1SL9880A00	1/2
Linear snap-fit coupling for rack rails H 35mm	1SL9907A00	1SL9907A00	1/2
Linear snap-fit coupling for rack rails H 50mm	1SL9886A00	1SL9886A00	1/2
Linear snap-fit coupling for rack rails H 75mm	1SL9887A00	1SL9887A00	1/2
Bracket fixing element complete with screws	1SL9893A00	1SL9893A00	1/10
L 150mm crosspiece for rack rails B 75-100mm	1SL9910A00	1SL9910A00	1/10
L 200mm crosspiece for rack rails B 150mm	1SL9911A00	1SL9911A00	1/10
L 250mm crosspiece for rack rails B 200mm	1SL9912A00	1SL9912A00	1/10
L 350mm crosspiece for rack rails B 300mm	1SL9913A00	1SL9913A00	1/10
L 450mm crosspiece for rack rails B 400mm	1SL9914A00	1SL9914A00	1/10
L 550mm crosspiece for rack rails B 500mm	1SL9915A00	1SL9915A00	1/10

1SL9910A00÷1SL9915A00

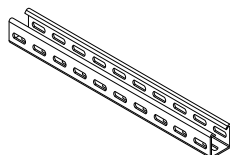

1SL9893A00



Note: The steel wire racks are also available in the following versions: unpainted Sendzimir; electrogalvanized; hot-dip galvanized after machining.

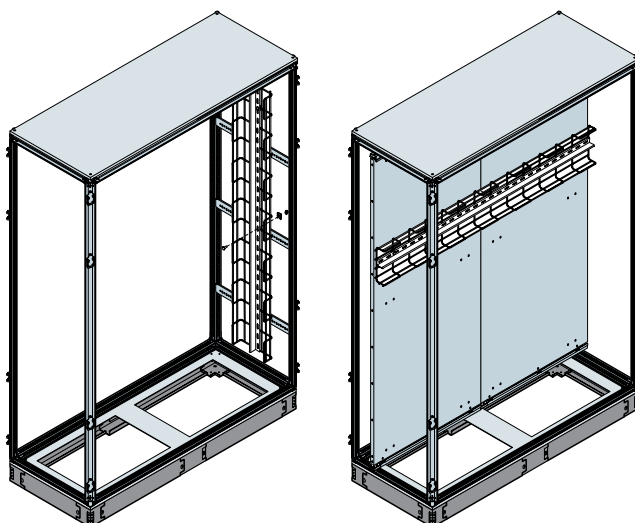

System pro E power

Order codes - Accessories

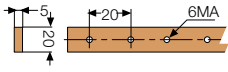

Earthing copper busbars

Flat busbar, drilled and threaded for earthing.

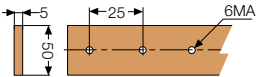
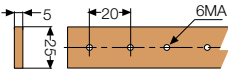

Description	ABB code	Codice ABB	Package/ No.pcs
No. 2 drilled and threaded busbars 20x5mm L=2000mm	EV1119	1STQ001014A0000	1/2
No. 2 drilled and threaded busbars 25x5mm L=2000mm	EV1120	1STQ001015A0000	1/2
No. 2 drilled and threaded busbars 50x5mm L=2000mm	EV1121	1STQ001016A0000	1/2

5



EV1122-EV1123
EV1124-EV1125

Insulators

Description	ABB code	Codice ABB	Package/ No.pcs
No.50 hexagonal insulators 30x30mm M6	EV1122	1STQ001017A0000	1/50
No.50 hexagonal insulators 30x30mm M8	EV1123	1STQ001018A0000	1/50
No.25 hexagonal insulators 36x50mm M6	EV1124	1STQ001019A0000	1/25
No.25 hexagonal insulators 36x50mm M8	EV1125	1STQ001020A0000	1/25

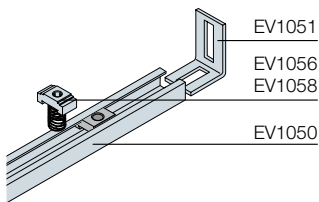

Sliding aluminium rails for general purposes

Description	ABB code	Codice ABB	Package/ No.pcs
No. 10 aluminium sections 30x15x1,8 - L=2000mm	EV1050	1STQ000981A0000	1/10
No. 25 fixing brackets for EV1050	EV1051	1STQ000982A0000	1/25
No. 100 M6 aluminium nuts for EV1050	EV1056	1STQ000983A0000	1/100
No. 100 M8 aluminium nuts for EV1050	EV1058	1STQ000984A0000	1/100

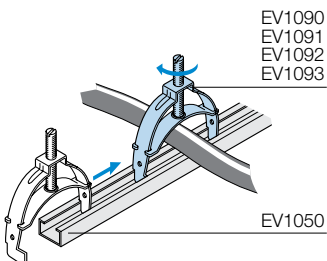

Brackets for anchoring cables

Adjustable cable clamping bracket. Can be mounted on sections with 10mm slot EV1050.

Description	ABB code	Codice ABB	Package/ No.pcs
No.10 cable clamping brackets Ø9÷16mm min÷max	EV1090	1STQ000999A0000	1/10
No.10 cable clamping brackets Ø16÷30mm min÷max	EV1091	1STQ001000A0000	1/10
No.5 cable clamping brackets Ø30÷48mm min÷max	EV1092	1STQ001001A0000	1/5
No.5 cable clamping brackets Ø48÷72mm min÷max	EV1093	1STQ001002A0000	1/5

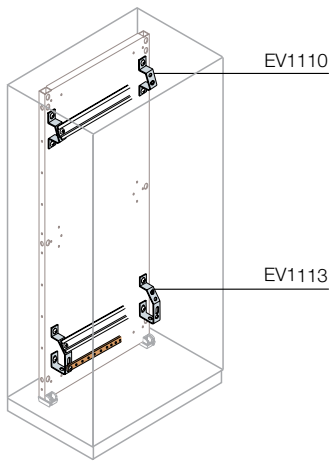

Angled supports for terminal boxes and earthing busbars

Description	Order code	ABB code	Package/ No.pcs
No.50 angled supports 1 row of terminals	EV1110	1STQ001007A0000	1/50
No.2 angled supports 1 row of terminals + earth	EV1113	1STQ003737A0000	1/2

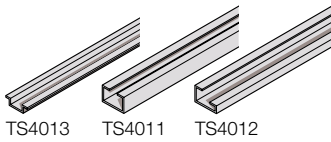

Profiles for accessories

Universal profiles of different types for mounting any component or for cable locking.

Description	Dimensions (mm) L	Order code	ABB code	Package/ No.pcs
No. 2 EN sections 5002 C30	2000	TS4011	1STQ008211A0000	1/2
No. 2 EN sections G32	2000	TS4012	1STQ008212A0000	1/2
No. 2 DIN EN sections 5022 35x7.5	2000	TS4013	1STQ008213A0000	1/2

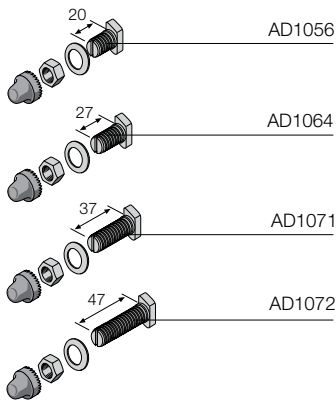

Hammer-head screws for shaped profile busbars

Description	Order code	ABB code	Package/ No.pcs
No.12 screws M8 - L=20mm for cable terminals	AD1056	1STQ008214A0000	1/12
No.12screws M8 - L=27mm for plates up to 10mm, complete with screw cap	AD1064	1STQ008215A0000	1/12
No.12 screws M8 - L=37mm for plates up to 20mm, complete with screw cap	AD1071	1STQ008216A0000	1/12
No.12 screws M8 - L=47mm for plates up to 30mm, complete with screw cap	AD1072	1STQ008217A0000	1/12

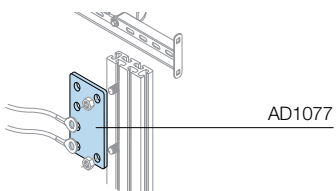

Couplings for shaped profile busbars

Description	Order code	ABB code	Package/ No.pcs
No.4 400A branch connectors in copper	AD1077	1STQ008218A0000	1/4

System pro E power

Order codes - Accessories

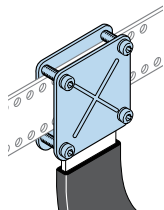

Busbar clamps

Kit for clamping flexible busbars to rigid busbars without forcing the flexible busbars.

Description	Order code	ABB code	Package/ No. pcs
2 pairs of fixing plates for busbars H=40mm	BS3250	1STQ008219A0000	1/4
2 pairs of fixing plates for busbars H=50mm	BS5050	1STQ008220A0000	1/4
2 pairs of fixing plates for busbars H=63mm	BS6350	1STQ008221A0000	1/4

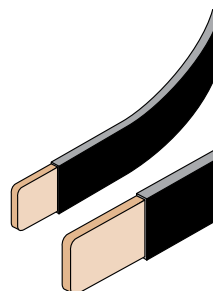

Barre flessibili

Barre flessibili isolate in materiale autoestinguente.

Description	WxW (mm)	Dimensions (mm)		Order code	ABB code	Package/ No. pcs
		L	In (A)			
No.2 flexible busbars	15.5x3.2	2000	160	PBFC0160	1STQ009175A0000	1/2
No.2 flexible busbars	20x3	2000	250	BF1602	1STQ008222A0000	1/2
No.2 flexible busbars	20x5	2000	400	BF2502	1STQ008223A0000	1/2
No.2 flexible busbars	24x6	2000	500	BF4002	1STQ008224A0000	1/2
No.2 flexible busbars	32x5	2000	630	BF4012 ⁽¹⁾	1STQ008225A0000	1/2
No.2 flexible busbars	40x8	2000	1000	BF6302	1STQ008226A0000	1/2
No.2 flexible busbars	50x10	2000	1250	BF8002	1STQ008227A0000	1/2

⁽¹⁾ Only for circuit-breakers with extended front connections or rear connections.

Lateral connection module for terminal ditching

Lateral drilled module 25mm pitch for fixing the crosspieces with insulating supports in width from the intermediate upright up to the rear structural upright. In order to complete the terminals ditching it is necessary to fix sideways the two connection modules included in the code. The crosspieces PCRM or PCRS is fixed using the special fixing brackets for module connection PBMC0002. The crosspiece is to be chosen and ordered separately according to the width of the structure.

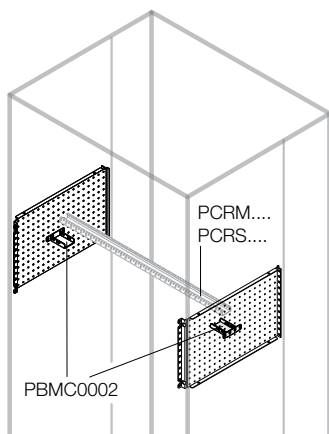

Description	H (mm)	D (mm)	Order code	ABB code	Package/ No. pcs
No.2 lateral connection modules	175	500	PMCS1755	1STQ009200A0000	1/2
No.2 lateral connection modules	200	500	PMCS2050	1STQ009201A0000	1/2
No.2 lateral connection modules	225	500	PMCS2255	1STQ009202A0000	1/2
No.2 lateral connection modules	250	500	PMCS2550	1STQ009203A0000	1/2
No.2 lateral connection modules	300	500	PMCS3050	1STQ009204A0000	1/2
No.2 lateral connection modules	175	700	PMCS1757	1STQ009205A0000	1/2
No.2 lateral connection modules	200	700	PMCS2070	1STQ009206A0000	1/2
No.2 lateral connection modules	225	700	PMCS2257	1STQ009207A0000	1/2
No.2 lateral connection modules	250	700	PMCS2570	1STQ009208A0000	1/2
No.2 lateral connection modules	300	700	PMCS3070	1STQ009209A0000	1/2
No.2 lateral connection modules	175	900	PMCS1759	1STQ009210A0000	1/2
No.2 lateral connection modules	200	900	PMCS2090	1STQ009211A0000	1/2
No.2 lateral connection modules	225	900	PMCS2259	1STQ009212A0000	1/2
No.2 lateral connection modules	250	900	PMCS2590	1STQ009213A0000	1/2
No.2 lateral connection modules	300	900	PMCS3090	1STQ009214A0000	1/2
No.2 fixing brackets connection module			PBMC0002	1STQ009215A0000	1/2

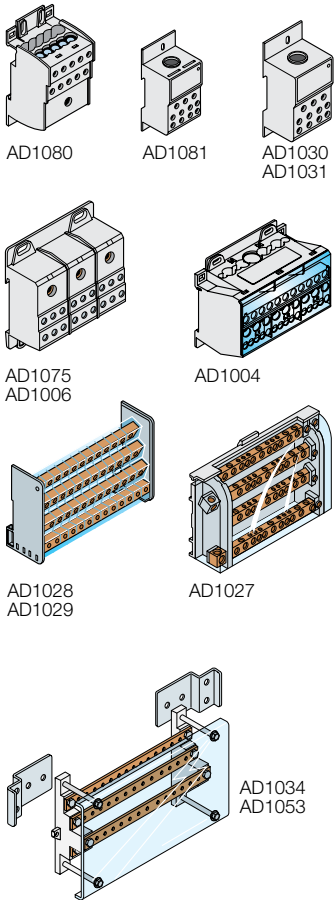

Splitters

Description	Order code	ABB code	Package/ No. pcs
Unipolari			
Modular 125A	AD1076 ⁽¹⁾	1STQ008287A0000	1/1
Modular 125A	AD1080 ⁽²⁾	1STQ008288A0000	1/1
Modular 175A	AD1007 ⁽¹⁾	1STQ008293A0000	1/1
Modular 175A	AD1081 ⁽²⁾	1STQ008289A0000	1/1
Modular 250A	AD1030	1STQ008297A0000	1/1
Modular 125A	AD1031	1STQ008298A0000	1/1
Threepole			
Modular 125A	AD1075	1STQ008286A0000	1/1
Modular 175A	AD1006	1STQ008292A0000	1/1
Four-pole			
Modular 125A	AD1004	1STQ008291A0000	1/1
Modular 125A-medium-93x89x48 (HxLxD)	AD1028	1STQ008295A0000	1/1
Modular 125A-large-96x126x48 (HxLxD)	AD1029	1STQ008296A0000	1/1
Modular 160A	AD1027	1STQ008294A0000	1/1
250A horizontal for L=600mm structures	AD1034	1STQ008345A0000	1/1
250A horizontal for L=800mm structures	AD1053	1STQ008346A0000	1/1
No.2 fixing brackets for AD1034-AD1053	PBRF3453	1STQ009184A0000	1/2

⁽¹⁾ 10 outputs - ⁽²⁾ 6 outputs

Assembly accessories

Description	Order code	ABB code	Package/ No. pcs
Joining accessory for two AD1080	AD1083	1STQ008290A0000	1/1

Labels

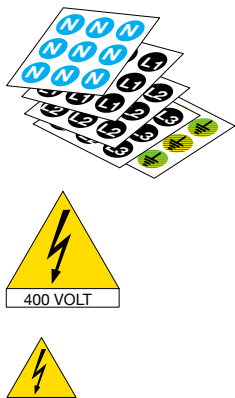

Description	Order code	ABB code	Package/ No. pcs
No.490 ø12mm adhesive labels with N symbol	EV1150	1STQ001033A0000	1/490
No.490 ø12mm adhesive labels with L1 symbol	EV1151	1STQ001034A0000	1/490
No.490 ø12mm adhesive labels with L2 symbol	EV1152	1STQ001035A0000	1/490
No.490 ø12mm adhesive labels with L3 symbol	EV1153	1STQ001036A0000	1/490
No.490 ø12mm adhesive labels with T symbol	EV1154	1STQ001037A0000	1/490
No.10 triangular 125mm adhesive labels with 400V lightning flash symbol	EV1155	1STQ001038A0000	1/10
No.300 triangular 20mm adhesive labels with lightning flash symbol	EV1156	1STQ001039A0000	1/300

System pro *E* power Segregations

General information

Segregations in accordance with Standard IEC 61439-1-2	6/2
Internal segregation kits	6/3
Segregation Form 2a - 3a	6/4
Segregation Form 2b	6/6
Segregation Form 3b	6/8
Segregation Form 4b	7/10
Choice of segregation	7/12

Guide to the order codes	6/20
--------------------------	------

Order code

Form 2a - 3a	6/22
Segregations busbars Form 2b - 3b - 4b	6/26
Form 3b	6/32
Form 4b	6/46

System pro E power

General information

Segregations in accordance with Standard IEC 61439-1-2

Segregation form means the type of division inside the switchboard. Segregation by means of metal or insulating barriers or partitions may be required to:

- Provide protection against direct contacts (at least IPXXB) when a de-energized part of a switchboard must be accessed while the rest of it remains energized.
- Reduce the possibility of internal arc ignition and propagation.
- Prevent solid bodies from passing between different parts of the switchboard (protection class at least IP2X).

Partition means the element that separates two compartments while the barrier protects the operator from direct contact and from the effects of the arc of a switching device in the usual direction of access. The partition can also be a casing that is an integral part of an apparatus, e.g. a moulded-case circuit-breaker.

Symbols	Form 1	Form 2	Form 3	Form 4
	<p>No internal segregation</p>	<p>Segregation of busbars from all functional units</p> <p>Form 2a The terminals for external conductors are not separated from the busbars</p>	<p>Segregation of busbars from all functional units.</p> <ul style="list-style-type: none"> - Segregation of all functional units from each other - Segregation of the terminals for external conductors and the external conductors from the functional units, but not from the terminals of other functional units <p>Form 3a The terminals for external conductors are not separated from the busbars</p>	<p>Segregation of busbars from all functional units.</p> <ul style="list-style-type: none"> - Segregation of all functional units from each other - Segregation of the terminals for external conductors associated with a functional unit from the terminals of any other functional unit and from the busbars - Segregation of the external conductors from the busbars - Segregation of the external conductors associated with a functional unit from other functional units and their terminals - The external conductors do not need to be separated from each other <p>Form 4a The terminals for external conductors are in the same compartment as associated functional unit</p>
		<p>Form 2b The terminals for external conductors are separated from the busbars</p>	<p>Form 3b The terminals for external conductors and the external conductors are separated from the busbars</p>	<p>Form 4b The terminals for external conductors are not in the same compartment as associated functional unit but are in individual spaces or compartments, separated, enclosed and protected</p>

Key

- a Empty enclosure
- b Internal segregation
- c Functional unit, including the terminals for the associated external conductors
- d Busbars, including the distribution busbars

Internal segregation kits

The different segregation Forms, (Form 2a, 2b, 3a, 3b and 4b), that can be created in the new System pro E power main distribution switchboard are described in the following pages.

The descriptions include the following information for each segregation Form:

- the basic conditions for its creation
- the various solutions
- the reference tables for the choice of codes

Generally speaking, the basic segregation Form of the circuit-breaker kits (Form 1) passes to Form 4b by adding different accessories in sequence, depending on the case in question.

The main innovation introduced by the new System pro E power segregation system concerns the kits for circuit-breakers with front (with high terminals*) and rear terminals for Form 2b.

The segregation Form 2a - 3a, 3b and 4b can be reached with front terminals (with high terminal covers*) or rear terminals only for fixed circuit-breakers. With plug-in or withdrawable circuit-breakers the segregations can be built up with rear terminals. Using side by side moulded case circuit-breakers and moulded case circuit breakers with recessed mounting plate the highest segregation form reachable is Form 3a. The side by side air circuit-breakers are not segregated.**

The segregations mainly consist of horizontal or vertical shelves at the front or rear in relation to the intermediate upright, or throughout the width/depth of structures without the intermediate upright.

The intermediate upright is required for all segregation Forms differing from Form 2b, even when not needed by the circuit-breaker version.

Segregation **Forma 2a - 3a**, designed for structures with $D \geq 500\text{mm}$, is created with side closing elements for the compartment and universal horizontal shelves to install between kits with different depths ($D \geq 38\text{mm}$), and above and below the kit compositions (top and bottom). With IP3X protection degree and cable compartment internal door it is necessary to install a vertical segregation and the intermediate upright (1 pcs. for internal cable container, 2 pcs. for external cable container). With IP65/IP4X and cable compartment internal door it is not necessary any further segregation. Blind compartments are specially created to fill the empty spaces inside the structure, while there are special closing segregations for DIN rails. The blind compartments are not suitable for fixing accessories. Install a blind bottom plate and panel if required. If the blind compartment is mounted in the first or in the last position into a column, the universal horizontal shelves cannot be mounted at the top or at the bottom.

Where the terminals are separated by the busbars, segregation **Form 2b** can be obtained by a combination of pre-cut or blind $H=800/1000\text{mm}$ side walls that cover the structure at the side along its entire height and with horizontal and vertical shelves for busbar segregation in structures with or without intermediate upright, for external and internal cable compartments. Some vertical walls are pre-cut so as to accommodate the busbars. To guarantee protection class $IP=20$, they have TPV rubber seals that adhere perfectly to the removed parts. If the column requires the installation of intermediate uprights, the cable container shall have the intermediate upright (1 pcs. for internal cable container, 2 pcs. for external cable container). If the column does not require the installation of intermediate uprights, no intermediate uprights have to be mounted into the cable container.

Segregation **Form 3b** is obtained by segregating the busbars from all the functional units, adding dedicated accessories for the installation of horizontal or vertical circuit-breakers. The horizontal circuit-breakers are segregated by means of sliding vertical rear separators that divide the input and output terminals, while the vertical circuit-breakers have a modular horizontal separator. The busbar side is segregated by panels fixed to the sides and bottom of the structure between the uprights. In case of segregation **Form 3b**, vertical breakers can be installed in the first available position under the top of the structure (top) or the last available position in the structure (bottom), with a maximum of two vertical breakers per column.

Segregation **Form 4b** is obtained for horizontal circuit-breakers by means of cubicles that completely isolate the circuit-breaker terminals. The rear part of the segregation is created by a Lexan panel fixed with a dedicated shelf and shelves, depending on the depth of the circuit-breaker. Form 4b is obtained for vertical circuit-breakers by duplicating the codes of the vertical bottom segregations and vertical side segregations used for **Form 3b**, closing the circuit-breaker compartment and installing an additional vertical side segregation on the output side.

In **Form 3b** and **Form 4b** the intermediate upright is always mandatory (1 pcs. for internal cable container, 2 pcs. for external cable container).

* High terminal covers are available for all Tmax T/XT fixed and Emax E1.2 fixed, except for XT1, XT3 F-RC and kit PHBX3301, PHBX3401, PHBX4301, PHBX4401, PHBT4301, PHBT4406, PHBT5306, PHBT5406 and Tmax T6/T7 withdrawable and plug-in versions. For Tmax XT1/XT2/XT3/XT4 withdrawable and plug-in versions it is necessary to order the dedicated adapter covers for terminals. For Tmax T4/T5 withdrawable and plug-in versions it is necessary to order the dedicated high terminal covers for 3 or 4 poles.

** See page 8/10.

System pro E power General information

Segregation Form 2a - 3a

6

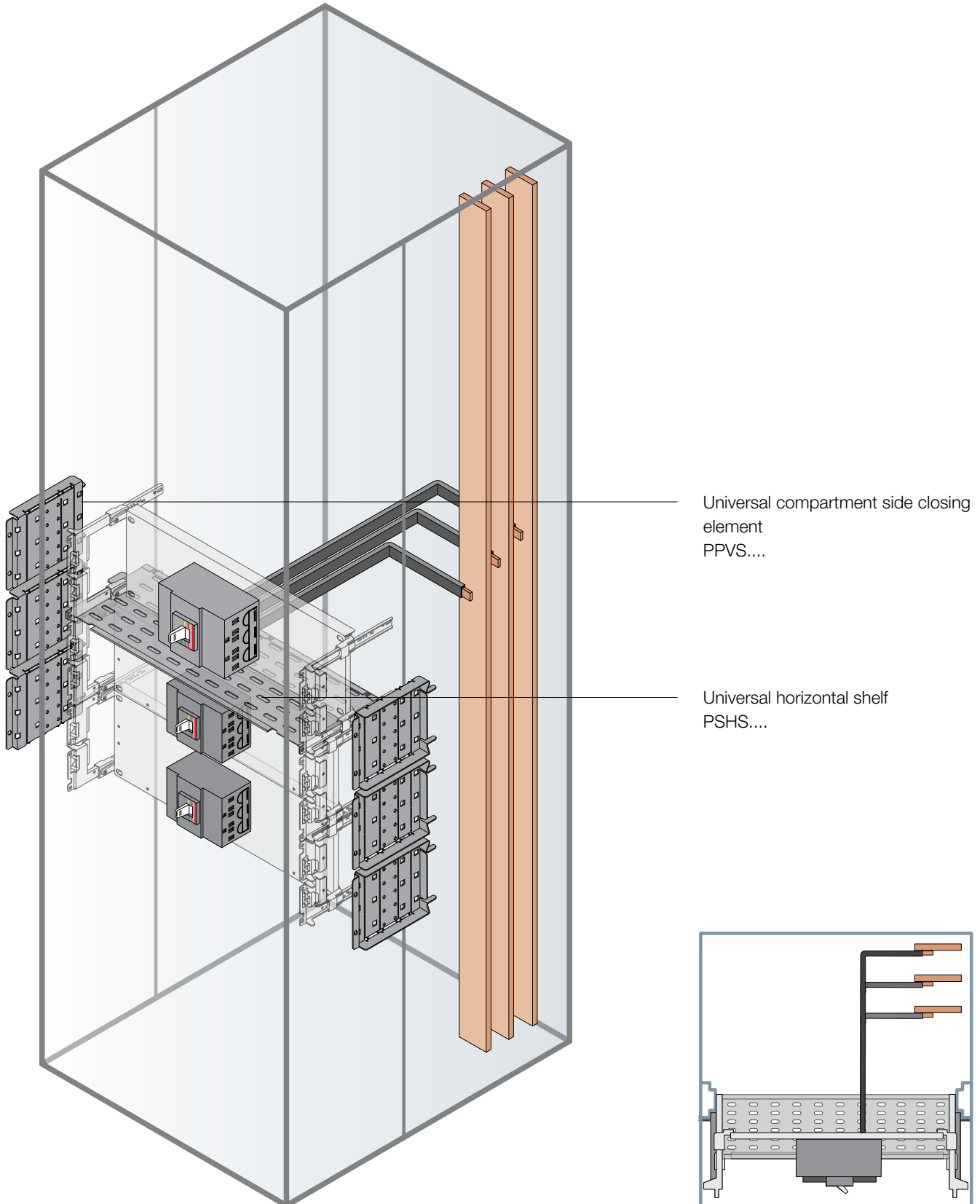

> Order codes page 6/20 > Technical details page 7/1

> Overall dimensions page 8/1

Examples of busbar use in the structure

Structures with intermediate upright

To obtain segregation Form 2a - 3a, use universal compartment side closing elements PPVS... and universal horizontal shelves PSHS... under the top and on the bottom, and whenever consecutive compartments contain circuit-breakers with $D \geq 38\text{mm}$ difference in depth.

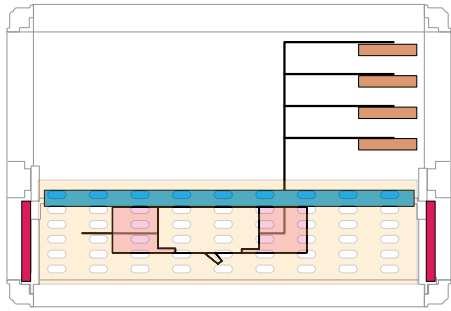

Horizontal circuit-breaker with front terminals

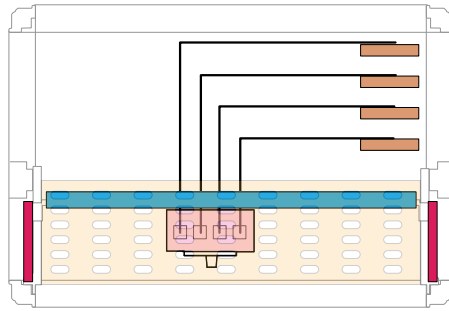

Vertical circuit-breaker with front terminals

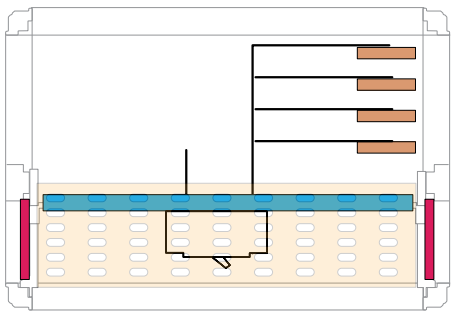

Horizontal circuit-breaker with rear terminals

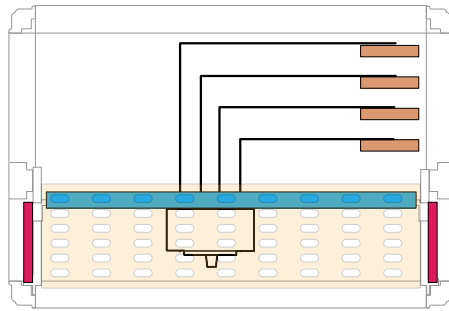

Vertical circuit-breaker with rear terminals

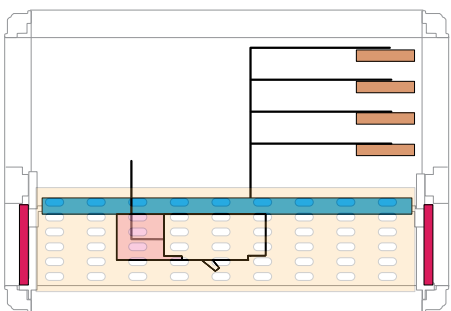

Horizontal circuit-breaker with front/rear terminals

High terminal covers are available for all Tmax T/XT fixed and Emax E1.2 fixed, except for XT1, XT3 F-RC and kit PHBX3301, PHBX3401, PHBX4301, PHBX4401, PHBT4301, PHBT4406, PHBT5306, PHBT5406 and Tmax T6/T7 withdrawable and plug-in versions. For Tmax XT1/XT2/XT3/XT4 withdrawable and plug-in versions it is necessary to order the dedicated adapter covers for terminals. For Tmax T4/T5 withdrawable and plug-in versions it is necessary to order the dedicated high terminal covers for 3 or 4 poles.

System pro E power

General information

Segregation Form 2b

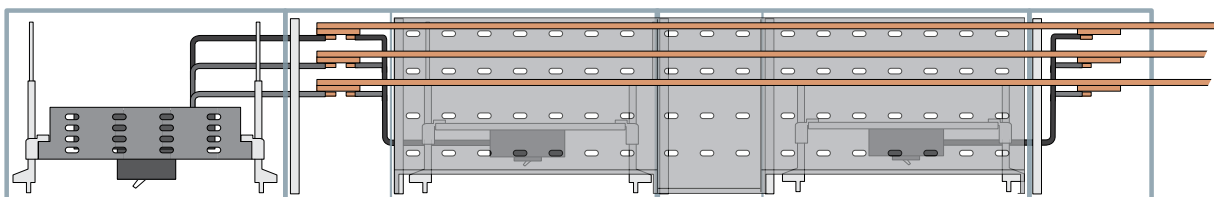
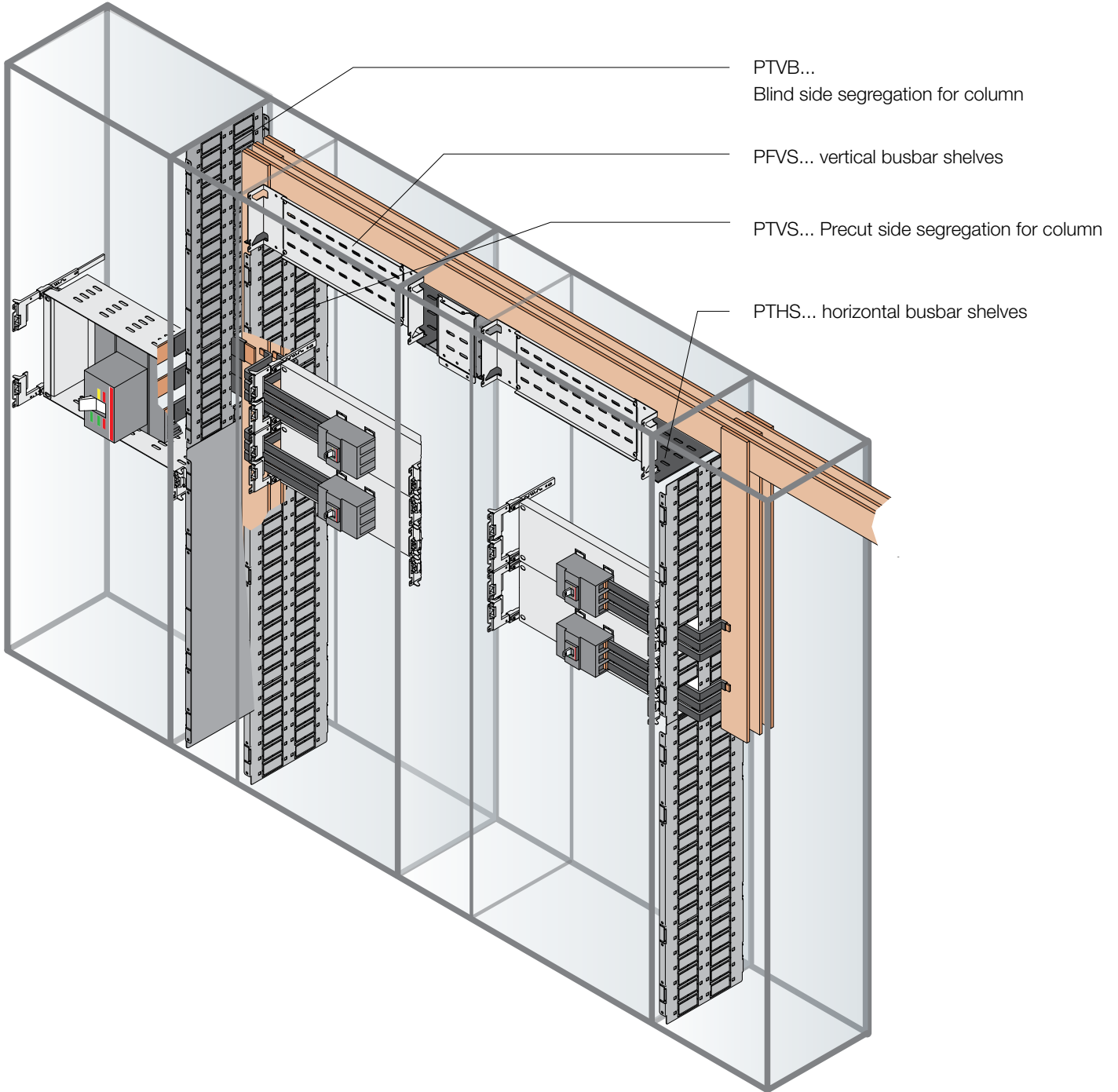

> Order codes page 6/20 > Technical details page 7/1

> Overall dimensions page 8/1

Examples of busbar use in the cable compartment

To obtain segregation Form 2b, use dedicated horizontal shelves PTHS.... and front segregations PFVS.... for the structure, internal cable compartment and external cable compartment. The busbars are segregated with precut PTVS... or blind PTVB... side segregations for columns, which can be full-depth for structures without intermediate uprights and divided into front and rear for structures with intermediate uprights. Terminal covers to be ordered with the circuit-breakers must be used for circuit-breakers with front terminals.

Structures without intermediate upright

Structures with intermediate upright

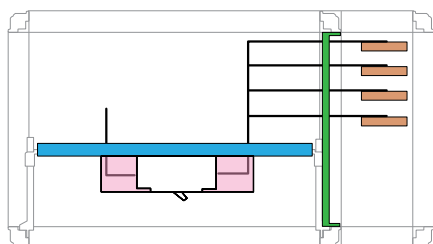

Horizontal circuit-breaker with front terminals rear outputs

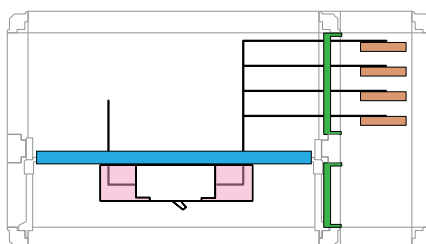

Horizontal circuit-breaker with front terminals rear outputs

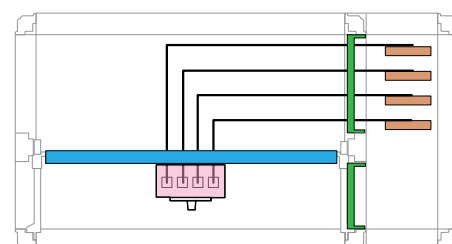

Vertical circuit-breaker with front terminals

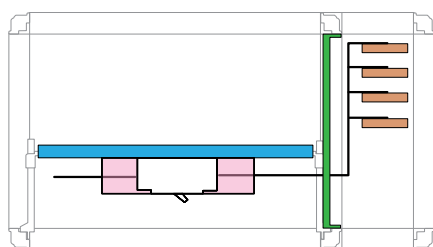

Horizontal circuit-breaker with front terminals side outputs

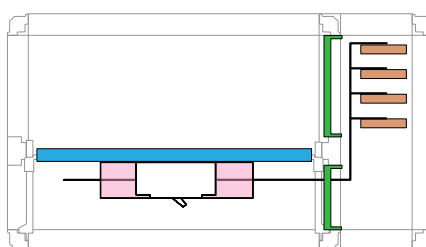

Horizontal circuit-breaker with front terminals side outputs

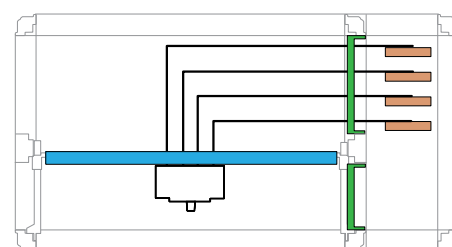

Vertical circuit-breaker with rear terminals

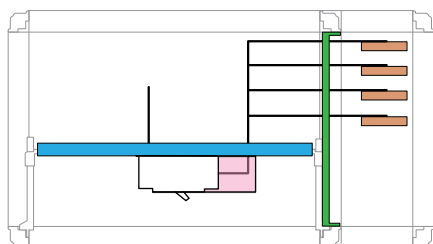

Horizontal circuit-breaker with front/rear terminals

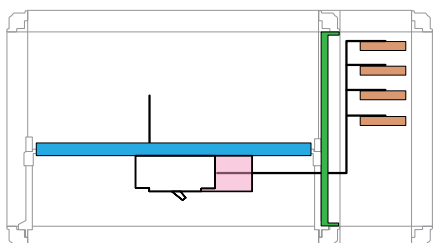

Horizontal circuit-breaker with front/rear terminals

High terminal covers are available for all Tmax T/XT fixed and Emax E1.2 fixed, except for XT1, XT3 F-RC and kit PHBX3301, PHBX3401, PHBX4301, PHBX4401, PHBT4301, PHBT4406, PHBT5306, PHBT5406 and Tmax T6/T7 withdrawable and plug-in versions. For Tmax XT1/XT2/XT3/XT4 withdrawable and plug-in versions it is necessary to order the dedicated adapter covers for terminals. For Tmax T4/T5 withdrawable and plug-in versions it is necessary to order the dedicated high terminal covers for 3 or 4 poles.

System pro E power

General information

Segregation Form 3b

6

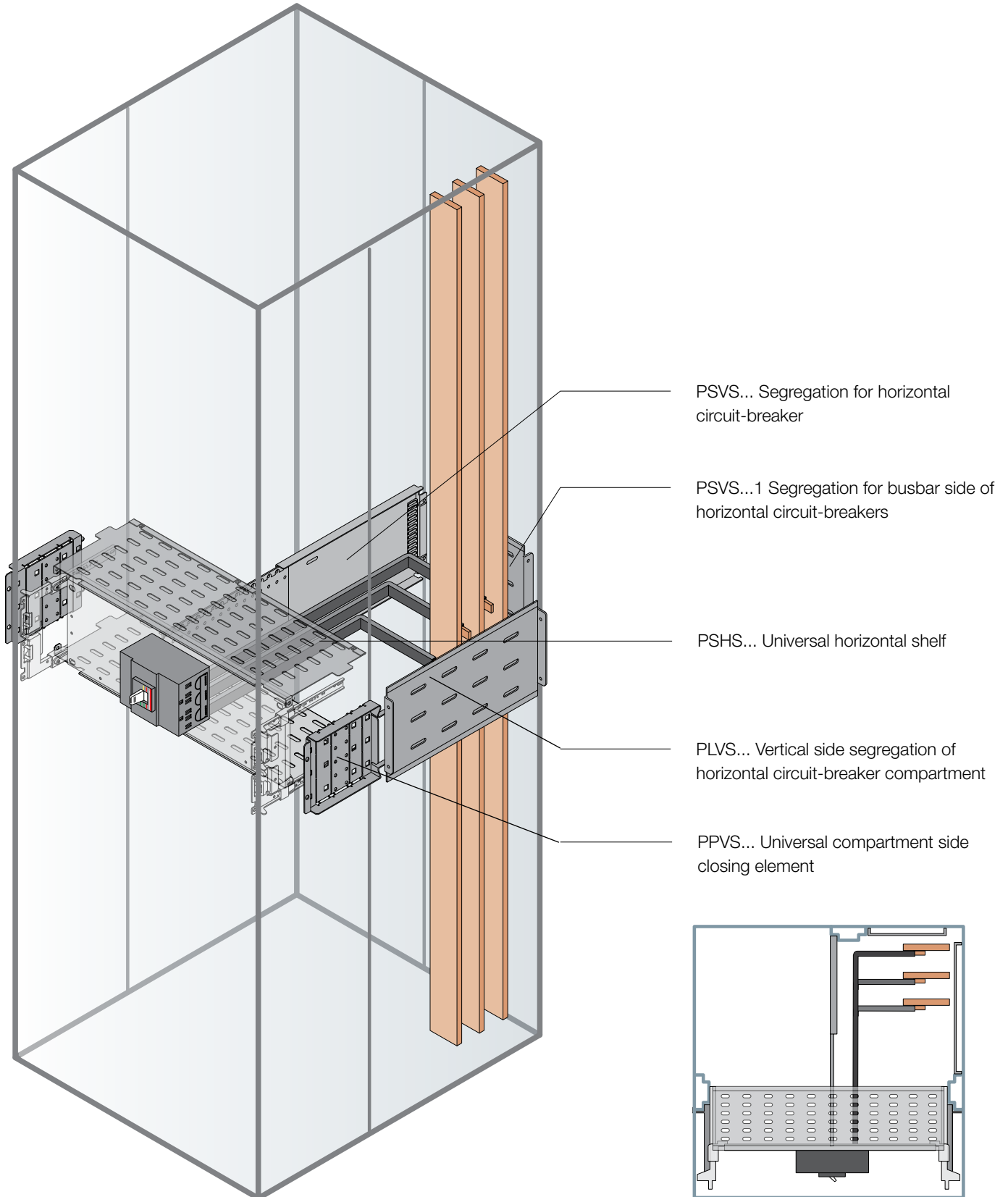

> Order codes page 6/20 > Technical details page 7/1

> Overall dimensions page 8/1

Examples of busbar use in the structure

Structures with intermediate upright

3b segregation begins with the components used for Form 2a - 3a with the addition of elements to separate the circuit-breaker terminals: for horizontal circuit-breakers this is obtained by means of sliding plate PSVS... while for vertical circuit-breakers, a precut shelf, PSHS..., is used for the passage of busbars. The busbar side must be isolated at the rear with PRVS...1 busbar side segregations and at the sides, with PLVS... side segregations. In case of segregation Form 3b, vertical breakers can be installed in the first available position under the top of the structure (top) or the last available position in the structure (bottom), with a maximum of two vertical breakers per column.

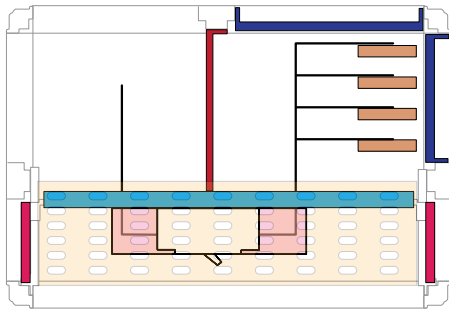

Horizontal circuit-breaker with front terminals

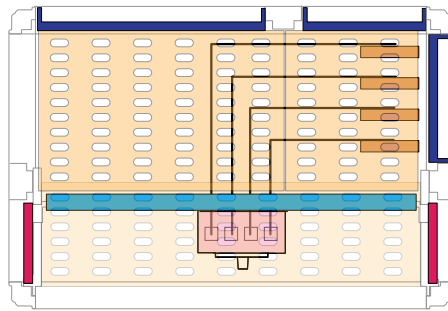

Vertical circuit-breaker with front terminals with rear intermediate upright*

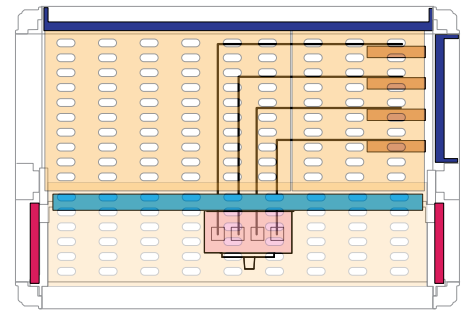

Vertical circuit-breaker with front terminals

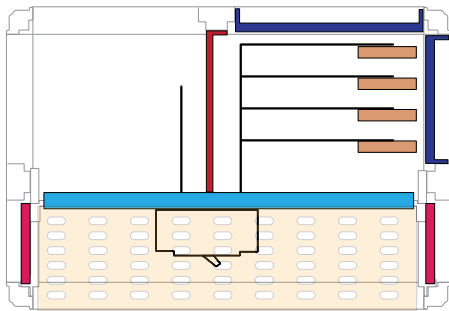

Horizontal circuit-breaker with rear terminals

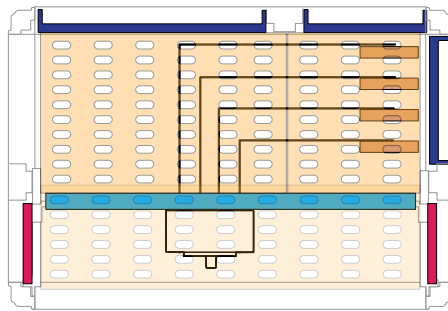

Vertical circuit-breaker with rear terminals with rear intermediate upright*

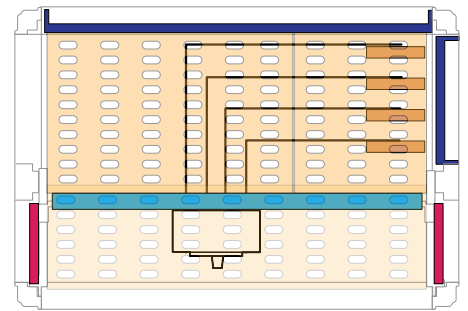

Vertical circuit-breaker with rear terminals

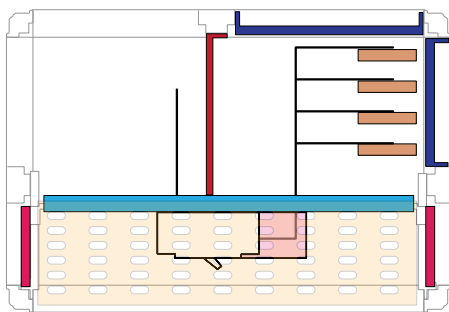

Horizontal circuit-breaker with front/rear terminals

* The rear intermediate upright is used when with the vertical breaker also an horizontal breaker is installed in the same column.

High terminal covers are available for all Tmax T/XT fixed and Emax E1.2 fixed, except for XT1, XT3 F-RC and kit PHBX3301, PHBX3401, PHBX4301, PHBX4401, PHBT4301, PHBT4406, PHBT5306, PHBT5406 and Tmax T6/T7 withdrawable and plug-in versions. For Tmax XT1/XT2/XT3/XT4 withdrawable and plug-in versions it is necessary to order the dedicated adapter covers for terminals. For Tmax T4/T5 withdrawable and plug-in versions it is necessary to order the dedicated high terminal covers for 3 or 4 poles.

> Order codes page 3/22 > Technical details page 7/1

> Overall dimensions page 8/1

System pro E power

General information

Segregation Form 4b

6

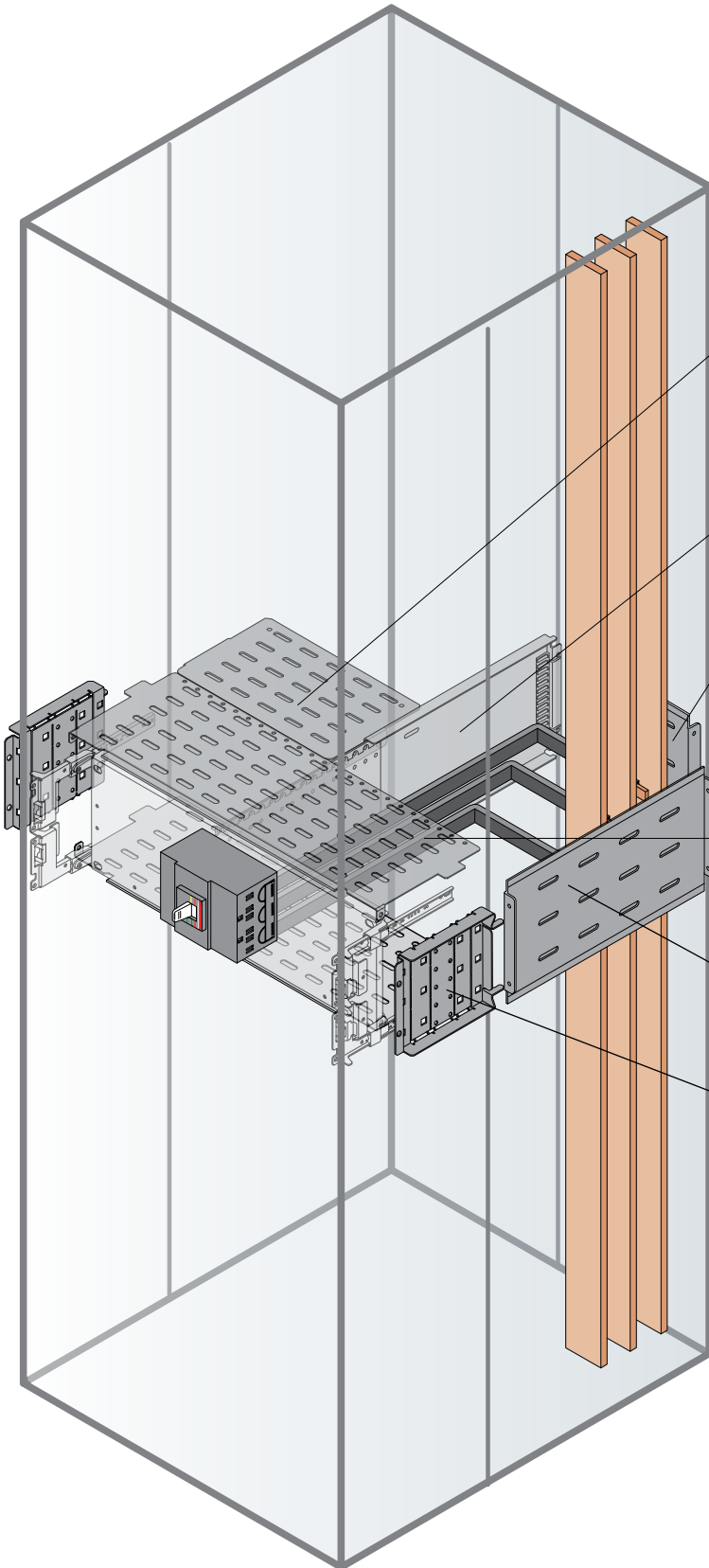

- PCVS...
Output closing cubicles, to create according to the depth and type of circuit-breaker
- PSVS...
Segregation for horizontal circuit-breaker
- PSVS...1 Segregation for busbar side of horizontal circuit-breakers
- PSHS... Universal horizontal shelf
- PLVS... Vertical side segregation of horizontal circuit-breaker compartment
- PPVS...
Universal compartment side closing element

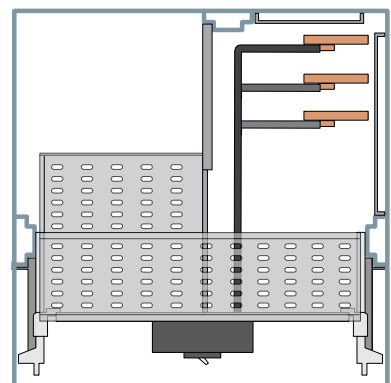

Examples of busbar use in the structure

Structures with intermediate upright

4b segregation begins with the components used for Form 2a - 3a - 3b. It is obtained by means of dedicated PCVS... cubicles chosen to suit the depth of the circuit-breaker, and horizontal shelves PSHS... required for each depth change of the output closing cubicles in the same column. Use universal vertical shelf PSHS.... for each compartment in order to reach Form 4b.

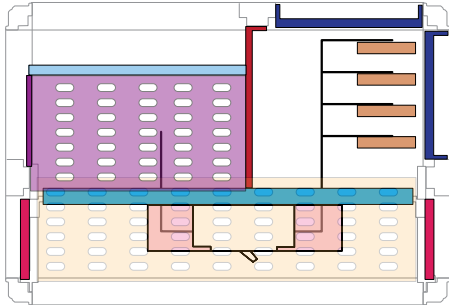

Horizontal circuit-breaker with front terminals

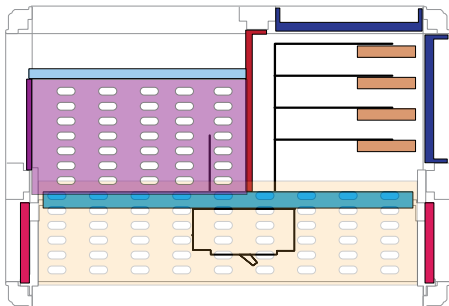

Horizontal circuit-breaker with rear terminals

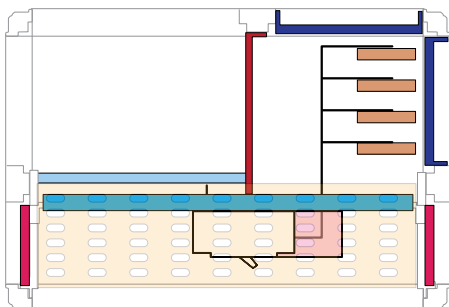

Horizontal circuit-breaker with front/rear terminals

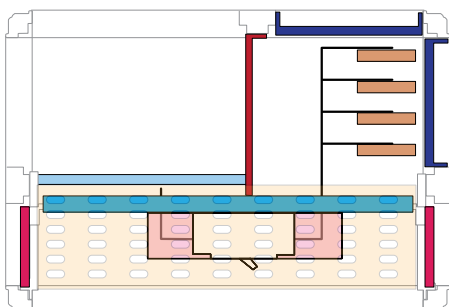

Horizontal circuit-breaker with front terminals

High terminal covers are available for all Tmax T/XT fixed and Emax E1.2 fixed, except for XT1, XT3 F-RC and kit PHBX3301, PHBX3401, PHBX4301, PHBX4401, PHBT4301, PHBT4406, PHBT5306, PHBT5406 and Tmax T6/T7 withdrawable and plug-in versions. For Tmax XT1/XT2/XT3/XT4 withdrawable and plug-in versions it is necessary to order the dedicated adapter covers for terminals. For Tmax T4/T5 withdrawable and plug-in versions it is necessary to order the dedicated high terminal covers for 3 or 4 poles.

System pro E power

General information

Choice of segregation to suit height of kits

Tmax T and Tmax XT moulded-case circuit-breakers

Horizontal installation

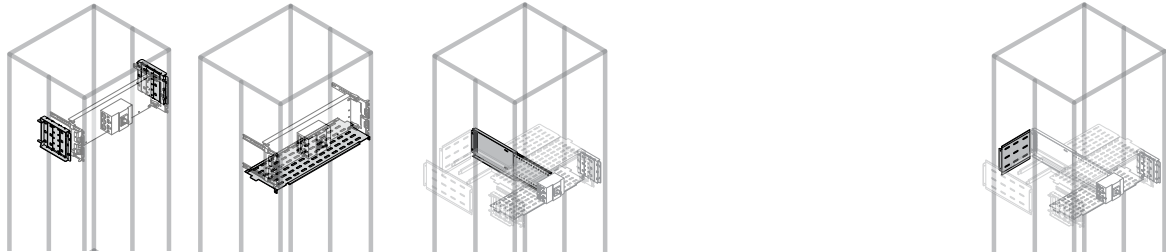

6 Height of kits (mm)	Form 2a	Form 3a ⁽²⁾		Form 3b			Rear vertical bottom segregation on busbar side		
	Universal compartment side closing element	Universal horizontal shelf		Vertical segregation of terminals					
		Width of structure (mm)	For all depths	Width of structure (mm)	Depth of structure (mm)			Width of structure (mm)	For all depths
200	PPVS2200	400	PSHS1904	400	PSVS2050	PSVS2070	PSVS2090	400	PRVS2041
		600	PSHS1906	600	PSVS2050	PSVS2070	PSVS2090	600	PRVS2061
		800	PSHS1908	800	PSVS2050	PSVS2070	PSVS2090	800	PRVS2081
250	PPVS2250	400	PSHS1904	400	PSVS2550	PSVS2570	PSVS2590	400	PRVS2541
		600	PSHS1906	600	PSVS2550	PSVS2570	PSVS2590	600	PRVS2561
		800	PSHS1908	800	PSVS2550	PSVS2570	PSVS2590	800	PRVS2581
300	PPVS2300	400	PSHS1904	400	PSVS3050	PSVS3070	PSVS3090	400	PRVS3041
		600	PSHS1906	600	PSVS3050	PSVS3070	PSVS3090	600	PRVS3061
		800	PSHS1908	800	PSVS3050	PSVS3070	PSVS3090	800	PRVS3081
		1000	PSHS1901	1000	PSVS3050	PSVS3070	PSVS3090	1000	
350	PPVS2350	400	PSHS1904	400	PSVS3550	PSVS3570	PSVS3590	400	PRVS3541
		600	PSHS1906	600	PSVS3550	PSVS3570	PSVS3590	600	PRVS3561
		800	PSHS1908	800	PSVS3550	PSVS3570	PSVS3590	800	PRVS3581
400	PPVS2400	400	PSHS1904	400	PSVS4050	PSVS4070	PSVS4090	400	PRVS4041
		600 ⁽¹⁾	PSHS1906	600	PSVS4050	PSVS4070	PSVS4090	600	PRVS4061
		800 ⁽¹⁾	PSHS1908	800	PSVS4050	PSVS4070	PSVS4090	800	PRVS4081
500	PPVS2500	400	PSHS1904	400	PSVS5050	PSVS5070	PSVS5090	400	PRVS5041
		600 ⁽³⁾	PSHS1906	600	PSVS5050	PSVS5070	PSVS5090	600	PRVS5061
		800 ⁽³⁾	PSHS1908	800	PSVS5050	PSVS5070	PSVS5090	800	PRVS5081
		1000	PSHS1901	1000	PSVS5050	PSVS5070	PSVS5090	1000	
600	PPVS2600	400	PSHS1904	400	PSVS6050	PSVS6070	PSVS6090	400	PRVS6041
		600	PSHS1906	600	PSVS6050	PSVS6070	PSVS6090	600	PRVS6061
		800	PSHS1908	800	PSVS6050	PSVS6070	PSVS6090	800	PRVS6081
700	PPVS2700	600	PSHS1906						

⁽¹⁾ Also for fixed/interlocked horizontal Emax 2 E1.2 for W=600mm and W=800mm.

⁽²⁾ To install only between kits with different depths (D_z≥38mm) and above and below the kit compositions (top and bottom).

⁽³⁾ For T7 withdrawable and withdrawable interlocked use the segregations for horizontal E1.2 withdrawable for W=600mm and W=800mm.

For the cubicles assembly position please refer to page 6/46 taking into consideration the breakers type.

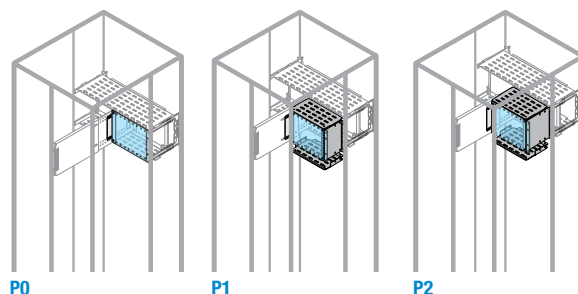
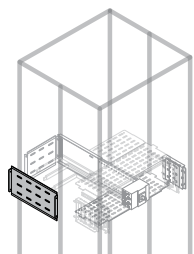

Side vertical segregation ^③				Form 4b		
Width of structure (mm)	Depth of structure (mm)			Cubicles to suit depth of circuit-breaker		
	500	700	900	Assembly position		
				P0	P1	P2
400	PLVS2052	PLVS2072	PLVS2092	PCVS0204	PCVS1204	PCVS2204
600	PLVS2052	PLVS2072	PLVS2092	PCVS0206	PCVS1206	PCVS2206
800	PLVS2052	PLVS2072	PLVS2092	PCVS0208	PCVS1208	PCVS2208
400	PLVS2552	PLVS2572	PLVS2592	PCVS0254	PCVS1254	PCVS2254
600	PLVS2552	PLVS2572	PLVS2592	PCVS0256	PCVS1256	PCVS2256
800	PLVS2552	PLVS2572	PLVS2592	PCVS0258	PCVS1258	PCVS2258
400	PLVS3052	PLVS3072	PLVS3092	PCVS0304	PCVS1304	PCVS2304
600	PLVS3052	PLVS3072	PLVS3092	PCVS0306	PCVS1306	PCVS2306
800	PLVS3052	PLVS3072	PLVS3092	PCVS0308	PCVS1308	PCVS2308
1000						
400	PLVS3552	PLVS3572	PLVS3592	PCVS0354	PCVS1354	PCVS2354
600	PLVS3552	PLVS3572	PLVS3592	PCVS0356	PCVS1356	PCVS2356
800	PLVS3552	PLVS3572	PLVS3592	PCVS0358	PCVS1358	PCVS2358
400	PLVS4052	PLVS4072	PLVS4092	PCVS0404	PCVS1404	PCVS2404
600	PLVS4052	PLVS4072	PLVS4092	PCVS0406	PCVS1406	PCVS2406
800	PLVS4052	PLVS4072	PLVS4092	PCVS0408	PCVS1408	PCVS2408
400	PLVS5052	PLVS5072	PLVS5092	PCVS0504	PCVS1504	PCVS2504
600	PLVS5052	PLVS5072	PLVS5092	PCVS0506	PCVS1506	PCVS2506
800	PLVS5052	PLVS5072	PLVS5092	PCVS0508	PCVS1508	PCVS2508
1000						
400	PLVS6052	PLVS6072	PLVS6092	PCVS0604	PCVS1604	PCVS2604
600	PLVS6052	PLVS6072	PLVS6092	PCVS0606	PCVS1606	PCVS2606
800	PLVS6052	PLVS6072	PLVS6092	PCVS0608	PCVS1608	PCVS2608

^③ Only required when columns are installed side by side, to separate the cable area and busbar area.

System pro E power

General information

Choice of segregation to suit height of kits

Tmax T and Tmax XT moulded-case circuit-breakers

Vertical installation

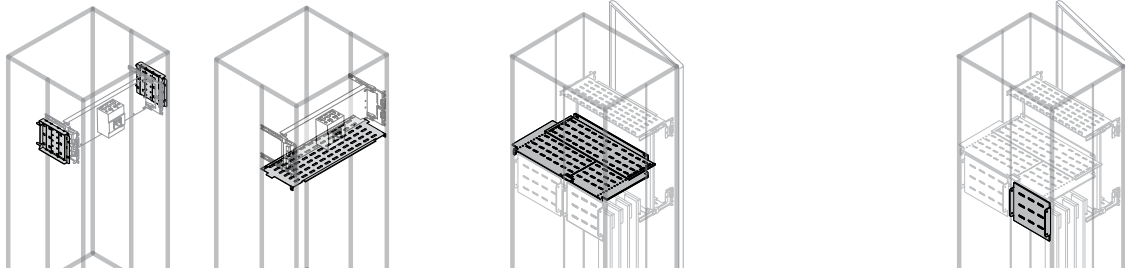

6	Height of kits (mm)	Form 2a	Form 3a ⁽²⁾		Form 3b				
		Universal compartment side closing element	Universal horizontal shelf		Horizontal segregation of terminals			Rear vertical bottom segregation on busbar side	
			Width of structure (mm)	For all depths	Depth of structure (mm)			Width of structure (mm)	For all depths
	200	PPVS2200	400	PSHS1904	PSHS4050	PSHS4070	PSHS4090	400	
			600	PSHS1906	PSHS6050	PSHS6070	PSHS6090	600	
			800	PSHS1908	PSHS8050	PSHS8070	PSHS8090	800	
			1000	PSHS1901				1000	
	300	PPVS2300	400	PSHS1904	PSHS4050	PSHS4070	PSHS4090	400	
			600	PSHS1906	PSHS6050	PSHS6070	PSHS6090	600	
			800	PSHS1908	PSHS8050	PSHS8070	PSHS8090	800	
			1000	PSHS1901				1000	
	350	PPVS2350	400	PSHS1904	PSHS4050	PSHS4070	PSHS4090	400	PRVS1741
			600	PSHS1906	PSHS6050	PSHS6070	PSHS6090	600	PRVS1761
			800	PSHS1908	PSHS8050	PSHS8070	PSHS8090	800	PRVS1781
			1000	PSHS1901				1000	
	400	PPVS2400	400	PSHS1904	PSHS4050	PSHS4070	PSHS4090	400	PRVS2041
			600	PSHS1906	PSHS6050	PSHS6070	PSHS6090	600	PRVS2061
			800	PSHS1908	PSHS8050	PSHS8070	PSHS8090	800	PRVS2081
			1000	PSHS1901				1000	
	450	PPVS2450	400 ⁽¹⁾	PSHS1904	PSHS4050	PSHS4070	PSHS4090	400	PRVS2241
			600 ⁽¹⁾	PSHS1906	PSHS6050	PSHS6070	PSHS6090	600	PRVS2261
			800 ⁽¹⁾	PSHS1908	PSHS8050	PSHS8070	PSHS8090	800	PRVS2251
			1000	PSHS1901				1000	
	500	PPVS2500	400	PSHS1904	PSHS4050	PSHS4070	PSHS4090	400	PRVS2541
			600 ⁽³⁾	PSHS1906	PSHS6050	PSHS6070	PSHS6090	600	PRVS2561
			800 ⁽³⁾	PSHS1908	PSHS8050	PSHS8070	PSHS8090	800	PRVS2581
			1000	PSHS1901				1000	
	600	PPVS2600	400	PSHS1904	PSHS4050	PSHS4070	PSHS4090	400	PRVS3041
			600	PSHS1906	PSHS6050	PSHS6070	PSHS6090	600	PRVS3061
			800	PSHS1908	PSHS8050	PSHS8070	PSHS8090	800	PRVS3081
			1000	PSHS1901				1000	
			1250					1250	

⁽¹⁾ Also for fixed/interlocked vertical Emax 2 E1.2 for L=400mm, L=600mm and L=800mm.

⁽²⁾ To install only between kits with different depths (D_z≥38mm) and above and below the kit compositions (top and bottom).

⁽³⁾ For T7 withdrawable and withdrawable interlocked use the segregations for vertical E1.2 withdrawable for W=600mm and W=800mm.

Form 4b

Form 4b is obtained by duplicating the codes of vertical bottom segregations PRVS... and vertical side segregations PLVS..., closing the circuit-breaker compartments over the entire height of the switchboard and installing an additional vertical side segregation on the output side.

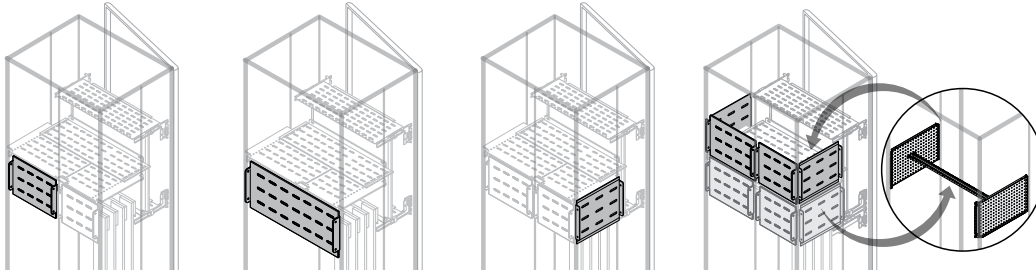

As an alternative to the PLVS... vertical side segregations, in the case of main circuit-breakers (Tmax T5, T6, T7), use the PMCS... side connection module for fixing terminal extensions and the relative fixing bshelfets PBMC0002 (page 4/40).

Vertical bottom segregation on busbar side		Full width vertical bottom segregation		Vertical side segregation		
Width of structure (mm)	For all depths	Width of structure (mm)	For all depths	Depth of structure (mm)		
				500	700	900
400		400				
600		600				
800		800				
1000		1000				
400		400				
600		600				
800		800				
1000		1000				
400		400	PRVS1740	PLVS1752	PLVS1772	PLVS1792
600	PRVS1762	600	PRVS1760	PLVS1752	PLVS1772	PLVS1792
800	PRVS1782	800	PRVS1780	PLVS1752	PLVS1772	PLVS1792
1000		1000	PRVS1710	PLVS1752	PLVS1772	PLVS1792
400		400	PRVS2040	PLVS2052	PLVS2072	PLVS2092
600	PRVS2062	600	PRVS2060	PLVS2052	PLVS2072	PLVS2092
800	PRVS2082	800	PRVS2080	PLVS2052	PLVS2072	PLVS2092
1000		1000	PRVS2010	PLVS2052	PLVS2072	PLVS2092
400		400	PRVS2240	PLVS2252	PLVS2272	PLVS2292
600	PRVS2262	600	PRVS2260	PLVS2252	PLVS2272	PLVS2292
800	PRVS2282	800	PRVS2280	PLVS2252	PLVS2272	PLVS2292
1000		1000	PRVS2210	PLVS2252	PLVS2272	PLVS2292
400		400		PLVS2552	PLVS2572	PLVS2592
600	PRVS2562	600	PRVS2560	PLVS2552	PLVS2572	PLVS2592
800	PRVS2582	800	PRVS2580	PLVS2552	PLVS2572	PLVS2592
1000		1000	PRVS2510	PLVS2552	PLVS2572	PLVS2592
400		400	PRVS3040	PLVS3052	PLVS3072	PLVS3092
600	PRVS3062	600	PRVS3060	PLVS3052	PLVS3072	PLVS3092
800	PRVS3082	800	PRVS3080	PLVS3052	PLVS3072	PLVS3092
1000		1000	PRVS3010	PLVS3052	PLVS3072	PLVS3092
1250		1250	PRVS3125			

System pro E power

General information

Choice of segregation

Emax 2 air circuit-breakers *

E1.2 withdrawable - E2.2 - E4.2 - E6.2 vertical

E1.2 withdrawable - E2.2 - E4.2 - E6.2 vertical

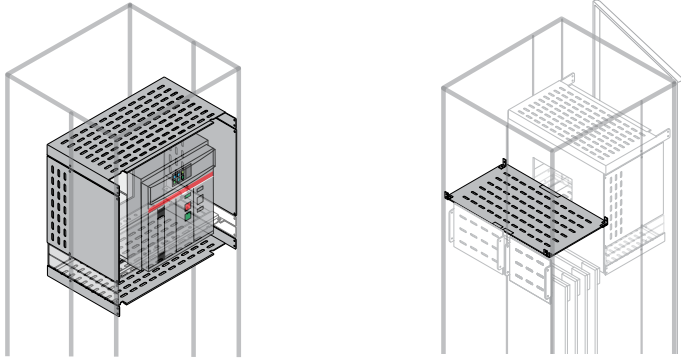

Vertical fixed Emax 2

Form 2a-3a				Form 3b					
Width of Kit/ column (mm)	Segregation kit			Width of Kit/column (mm)	Horizontal terminal separator				
	E2.2	E4.2	E6.2		E2.2	E2.2	E4.2	E4.2	E6.2
	Height of kits (mm)				Depth (mm)				
600	600	600	700	600	700	900	700	900	900
600	PSVF6062	PSVF6064		600	PSHF6072	PSHF6092	PSHF6072	PSHF6092	
800	PSVF6082	PSVF6084		800	PSHF8072	PSHF8092	PSHF8072	PSHF8092	
1000			PSVF7016	1000					PSHF1096
1250			PSVF7126	1250					PSHF1296

Vertical withdrawable Emax 2

Form 2a-3a					Form 3b									
Width of Kit/column (mm)	Segregation kit				Width of Kit/ column (mm)	Horizontal terminal separator								
	E1.2	E2.2	E4.2	E6.2		E1.2	E1.2	E1.2	E2.2	E2.2	E4.2	E4.2	E6.2	
	Height of kits (mm)					Depth (mm)								
500	500	600	600	700	500	700	900	700	900	700	900	900		
600	PSVW5061 ⁽¹⁾	PSVW6062	PSVW6064		600	PSHW6051 ⁽¹⁾	PSHW6071 ⁽¹⁾	PSHW6091	PSHW6072	PSHW6092	PSHW6074	PSHW6094		
800	PSVW5081 ⁽¹⁾	PSVW6082	PSVW6084		800	PSHW8051 ⁽¹⁾	PSHW8071 ⁽¹⁾	PSHW8091	PSHW8072	PSHW8092	PSHW8074	PSHW8094		
1000				PSVW7016	1000							PSHW1096		
1250				PSVW7126	1250							PSHW1296		

Horizontal withdrawable Emax 2

Height of kits (mm)	Form 2a-3a		Form 3b		Form 4b	
	Segregation kit		Vertical terminal separator		Rear cubicle	
	E1.2		E1.2		E1.2	
Width of kits (mm)		Depth (mm)		Width of column (mm)		
600	600	800	700	900	600	800
500	PSHW5061 ⁽²⁾	PSHW5081 ⁽²⁾	PSVS0055 ⁽²⁾	PSVS0057 ⁽²⁾	PCVS5060 ⁽²⁾	PCVS5080 ⁽²⁾

* For horizontal/vertical Emax E1.2 fixed see page 7/12 (kit H=400mm) and 7/14 (kit H=450mm).

⁽¹⁾ Also suitable for vertical T7 withdrawable and withdrawable interlocked.

⁽²⁾ Also suitable for horizontal T7 withdrawable and withdrawable interlocked.

Form 2a-3a

Form 3b-4b

E1.2 horizontal

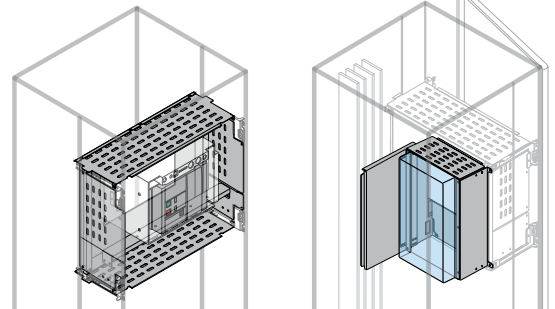

> Order codes page 6/20 > Technical details page 7/1

> Overall dimensions page 8/1

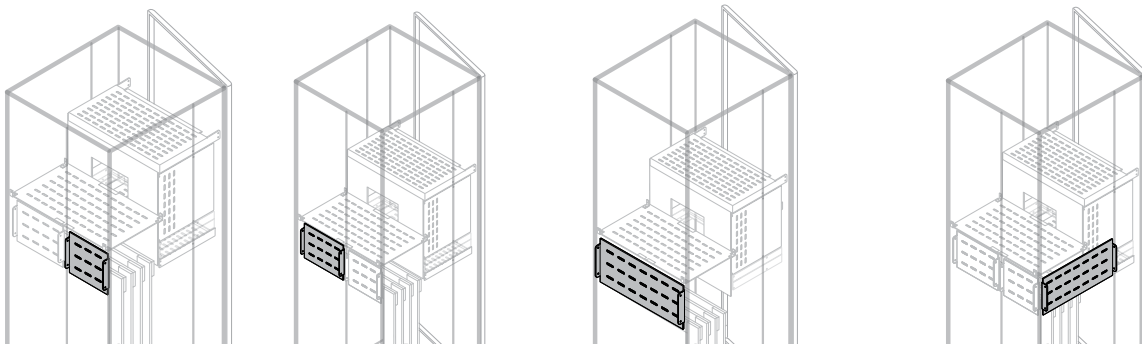

Bottom segregations					Side segregations						
Width of Kit/column (mm)	Structures with rear intermediate upright on busbar side		Structures with rear intermediate upright on output side		Structures without intermediate rear upright full-width segregation			Assembly between intermediate upright and rear structural upright			
	E2.2/E4.2		E2.2/E4.2		E2.2/E4.2		E6.2	Depth (mm)	E2.2/E4.2		E6.2
	Height of kits (mm)								Height of kits (mm)		
600	600		600		600		700	700	600		700
600	PRVS3061		PRVS3062		PRVS3060			700	PLVS3072		PLVS3572
800	PRVS3081		PRVS3082		PRVS3080			900	PLVS3092		PLVS3592
1000					PRVS3010		PRVS3510				
1250					PRVS3125		PRVS3501				

Bottom segregations								Side segregations									
Width of Kit/column (mm)	Structures with rear intermediate upright on busbar side				Structures with rear intermediate upright on output side				Structures without intermediate rear upright full-width segregation				Assembly between intermediate upright and rear structural upright				
	Height of kits (mm)				Height of kits (mm)				Height of kits (mm)			Depth (mm)					
	500		600		500		600		500		600	700	500	500		700	900
600	PRVS2561		PRVS3061		PRVS2562		PRVS3062		PRVS2560		PRVS3060		500	PLVS2552		PLVS2572	PLVS2592
800	PRVS2581		PRVS3081		PRVS2582		PRVS3082		PRVS2580		PRVS3080		600	PLVS3052		PLVS3072	PLVS3092
1000									PRVS2510		PRVS3010	PRVS3510	700	PLVS3552		PLVS3572	PLVS3592
1250									PRVS2512		PRVS3125	PRVS3501					

Form 2b

Breakers with rear terminals use dedicated kit 2a-3a and shelf PTHS... page 6/30.

Vertical circuit-breakers Form 4b

Form 4b is obtained by duplicating the codes of vertical bottom segregations PRVS... and vertical side segregations PLVS..., closing the circuit-breaker compartments over the entire height of the switchboard and installing an additional vertical side segregation on the output side.

As an alternative to the PLVS... vertical side segregations, in the case of main circuit-breakers, use the PMCS... side connection module for fixing terminal extensions and the relative fixing shelvesets PBMC0002 (page 4/40).

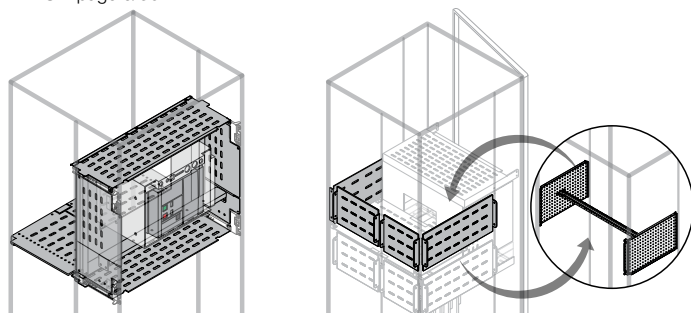

System pro E power

General information

Choice of busbars segregation

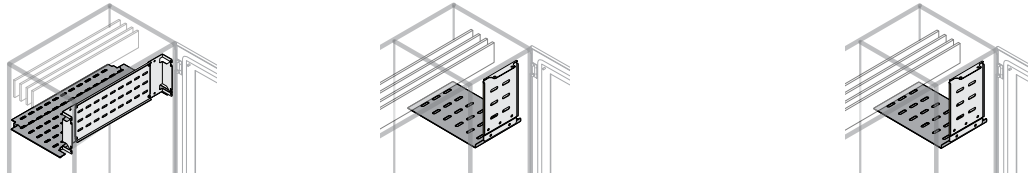

Horizontal busbars

Segregation for horizontal busbars: at top, at the bottom and at each height ⁽¹⁾															
Structure		External cable compartment								Internal cable compartment					
Form 2b		Form 2b, 3b, 4b								Form 2b, 3b, 4b					
Without intermediate upright		Without intermediate upright								Without intermediate upright side structure					
Width (mm)	Horizontal shelves			Front segregations	Horizontal shelves				Front segregations	Horizontal shelves				Front segregations	
	Depth (mm)	500	700	Height (mm)	Depth (mm)	500	700	900	Height (mm)	Depth (mm)	500	700	900	Height (mm)	
200															PTHS2030 : PTHS2050 : PTHS2070 : PTHS2090 : PFVS2220
300					PTHS3030	PTHS3050	PTHS3070	PTHS3090	PFVS2130						
400	PTHS4030	PTHS4050	PTHS4070	PFVS2040	PTHS4030	PTHS4050	PTHS4070	PTHS4190	PFVS2140	PTHS4230	PTHS4250	PTHS4270	PTHS4290	PFVS2240	
600	PTHS6030	PTHS6050	PTHS6070	PFVS2060											
800	PTHS8030	PTHS8050	PTHS8070	PFVS2080											
1000															
1250															

⁽¹⁾ Busbars at each height are foreseen only for segregation form different from Form 2b.
For the closing at the back off the structure use Form 3b segregations PRVS.... busbars/outgoing side at whole height.

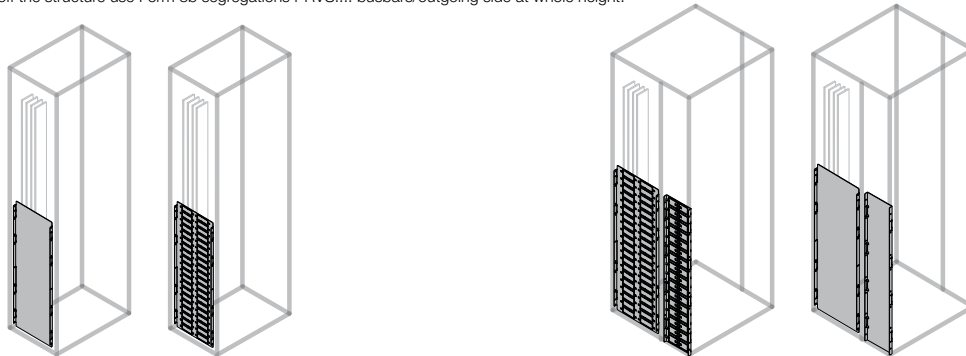

Vertical busbars

Side segregation for vertical busbars										
Structure										
Form 2b		Form 2b ⁽²⁾				Form 2b, 3b, 4b				
Without intermediate upright		With intermediate upright								
		Front				Rear				
Height (mm)	Type	Depth (mm)				Depth (mm)				
		200	300	500	700	179	500	700	900	
700	blind						PLVS7052	PLVS7072	PLVS7092	
800	blind	PTBS8020	PTBS8030	PTBS8050	PTBS8070	PTBS8001	PTBS8052	PTBS8072	PTBS8091	
1000	blind	PTBS1020	PTBS1030	PTBS1050	PTBS1070	PTBS1001	PTBS1052	PTBS1072	PTVB1091	
800	pre-cut	PTVS8020	PTVS8030	PTVS8050	PTVS8070	PTVS8001	PTVS8052	PTVS8072	PTVS8091	
1000	pre-cut	PTVS1020	PTVS1030	PTVS1050	PTVS1070	PTVS1001	PTVS1052	PTVS1072	PTVS1091	

⁽²⁾ Segregation Form 3b, 4b from the intermediate upright up to the front structural upright can be obtained only by means of lateral segregation closing Form 2a-3a.
For the closing at the back off the structure use Form 3b segregations PRVS.... busbars/outgoing side at whole height.

> Order codes page 6/20 > Technical details page 7/1 > Overall dimensions page 8/1

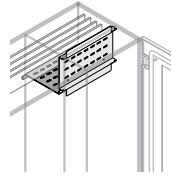
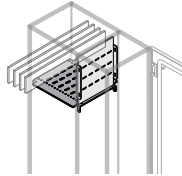
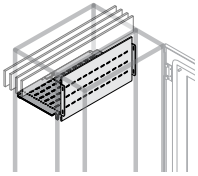

Segregation for horizontal busbars: at top, at the bottom and at each height ⁽¹⁾

Structure					External cable compartment					Internal cable compartment									
Form 2b, 3b, 4b					Form 2b, 3b, 4b					Form 2b, 3b, 4b					Form 3b, 4b				
With intermediate upright					With intermediate upright					With intermediate upright side structure									
Horizontal shelves			Front segregations		Horizontal shelves			Front segregations		Horizontal shelves			Front segregations		Front segregations at each heights				
Depth (mm)			Height (mm)		Depth (mm)			Height (mm)		Depth (mm)			Height (mm)		Height (mm)				
500	700	900	200 ⁽²⁾	300 ⁽³⁾	500	700	900	200 ⁽²⁾	300 ⁽³⁾	500	700	900	200	300	200 ⁽²⁾	300 ⁽³⁾			
										PHTS2052		PHTS2072	PHTS2092	PFVS2222	PFVS3222	PFVS2223	PFVS3223		
										PHTS3052		PHTS3072	PHTS3092	PFVS2132	PFVS3132				
PHTS4052	PHTS4072	PHTS4092	PFVS2042	PFVS3042	PHTS4152	PHTS4172	PHTS4192	PFVS2042	PFVS3042	PHTS4252	PHTS4272	PHTS4292	PFVS2242	PFVS3242	PFVS2243	PFVS3243			
PHTS6052	PHTS6072	PHTS6092	PFVS2062	PFVS3062															
PHTS8052	PHTS8072	PHTS8092	PFVS2082	PFVS3082															
PHTS1052	PHTS1072	PHTS1092	PFVS2012	PFVS3012															
			PHTS1292	PFVS2122	PFVS3122														

⁽¹⁾ Busbars at each height are foreseen only for segregation form different from Form 2b.

⁽²⁾ For busbars at each height ≤100mm; for busbars at the top/bottom < 120mm.

⁽³⁾ For busbars at each height >100mm; for busbars at the top/bottom >120mm.

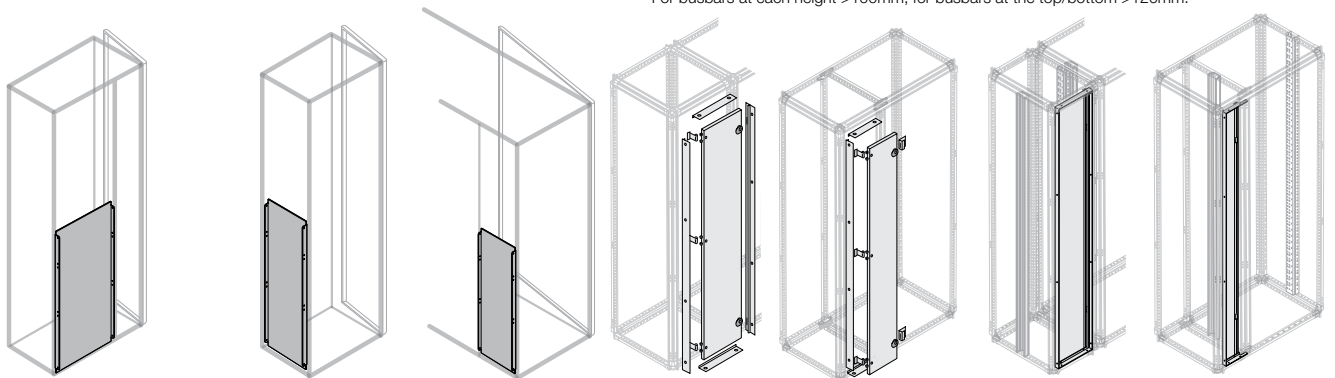

Cable compartment

Height (mm)	Blind side segregation for external cable compartment with intermediate upright			Rear segregation for external cable compartment		Rear segregation for internal cable compartment with rear intermediate upright		Internal door for external cable compartment		Internal door for internal cable compartment		Front vertical segregation for external cable compartment		Front vertical segregation for internal cable compartment	
	Depth (mm)			Width (mm)		Width (mm)		Width (mm)		Width (mm)		Width (mm)		Width (mm)	
	500	700	900	300	400	200	400	300	400	200	400	300	400	200	400
700	PLVS7052	PLVS7072	PLVS7092												
800	PTBS8052	PTBS8072	PTBS8091	PRVS8062	PRVS8082	PRBS8220	PRBS8240								
1000	PTBS1052	PTBS1072	PTVB1091	PRVS1062	PRVS1082	PRBS1220	PRBS1240								
1800								PDCB1830	PDCB1844	PDCB1820	PDCB1840	PFVS8030	PFVS8040	PFBS8020	PFBS8040
2000								PDCB2030	PDCB2044	PDCB2020	PDCB2040	PFVS1030	PFVS1040	PFBS1020	PFBS1040

System pro E power

Guide to the order codes

The new code is formed by 4 letters standing for English terms and 4 numbers, without spaces in between.

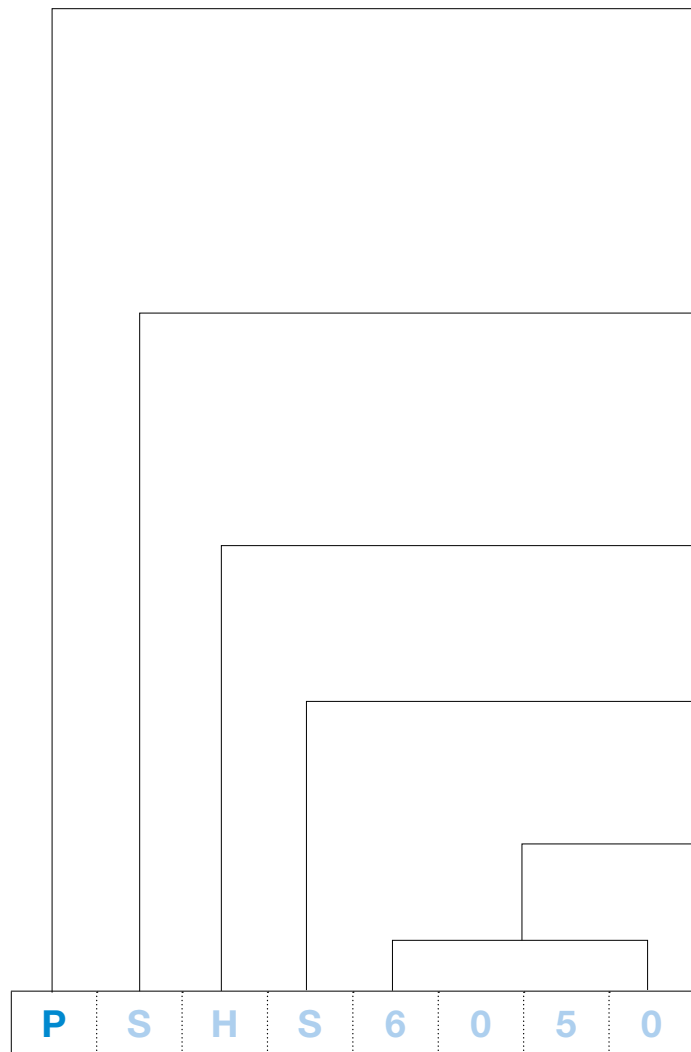

RANGE IDENTIFIER

The first letter of all the codes of the new main distribution switchboard "**P**" stands for "**power**". Thus the new product is clearly identified by the same initial used for all new components of ABB's System pro E power

TYPE OF PRODUCT AND CHARACTERISTICS

The second letter in the code indicates the type of product or component of the switchboard. The third and fourth letters describe the characteristics or material in more detail.

- S** = Segregation
- R** = Rear
- L** = Lateral
- C** = Crosspiece
- P** = Pre-cut
- F** = Frontal
- C** = Cell
- T** = Total

- V** = Vertical
- H** = Horizontal
- B** = Blind
- R** = Rubber
- D** = Nylon

- S** = Structure/Struttura Segregation/Segregazione
- F** = Fixed/Fisso
- W** = Withdrawable/Estraibile

MEASUREMENTS

The last 4 numbers usually refer to a measurement of the component or several dimensions pertaining to the code.

System pro E power

Order codes - Form 2a-3a segregations

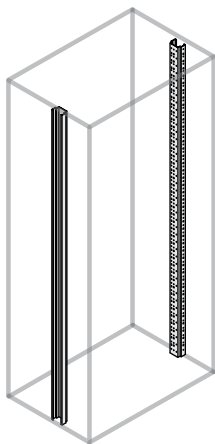

Intermediate side and rear upright for assembly of internal kits and segregations

The intermediate upright is the same as the one used for installing the kits and can be assembled both on the side and bottom of the structure.

Description	Dimensions (mm)	Order code	ABB code	Package/ No. pcs
	H			
Intermediate upright	1800	PUKI1800	1STQ008039A0000	1/1
Intermediate upright	2000	PUKI2000	1STQ008040A0000	1/1

6

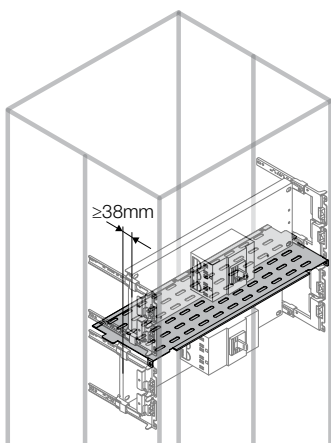

Universal horizontal shelf

Horizontal shelf to use whenever the plates of the circuit-breakers are further than 38mm, and above and below the kit compositions (top and bottom). For structures with intermediate uprights.

Description	Dimensions (mm)	Order code	ABB code	Package/ No. pcs
	W			
Universal horizontal shelf	400	PSHS1904	1STQ008691A0000	1/1
Universal horizontal shelf	600	PSHS1906	1STQ008692A0000	1/1
Universal horizontal shelf	800	PSHS1908	1STQ008693A0000	1/1
Universal horizontal shelf	1000	PSHS1901	1STQ008694A0000	1/1

Universal compartment side closing element

Precut universal compartment side closing element for use with both horizontal and vertical circuit-breakers. Pre-engineered for housing compartment side closing elements in rubber. For structures with intermediate uprights.

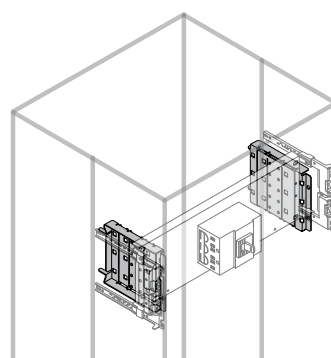

Description	Dimensions (mm)	Order code	ABB code	Package/ No. pcs
	H			
2 compartment side closing elements	200	PPVS2200	1STQ008695A0000	1/2
2 compartment side closing elements	250	PPVS2250	1STQ008696A0000	1/2
2 compartment side closing elements	300	PPVS2300	1STQ008697A0000	1/2
2 compartment side closing elements	350	PPVS2350	1STQ008698A0000	1/2
2 compartment side closing elements	400	PPVS2400	1STQ008699A0000	1/2
2 compartment side closing elements	450	PPVS2450	1STQ008700A0000	1/2
2 compartment side closing elements	500	PPVS2500	1STQ008701A0000	1/2
2 compartment side closing elements	600	PPVS2600	1STQ008702A0000	1/2
2 compartment side closing elements	700	PPVS2700	1STQ009228A0000	1/2

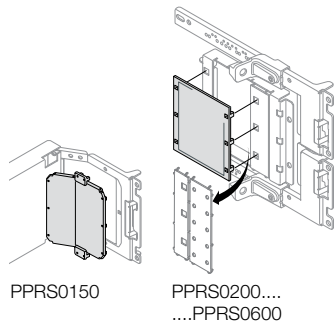

Rubber cover for closing compartments at the side

Rubber cover for closing compartments at the side and routing connections

Description	Cell dimensions (mm)		Rubber dimensions (mm)		Order code	ABB code	Package/ No. pcs
	H		H				
Rubber cover	150		-		PPRS0150	1STQ008726A0000	1/1
Rubber cover	200		150		PPRS0200	1STQ008583A0000	1/1
Rubber cover	250		200		PPRS0250	1STQ008584A0000	1/1
Rubber cover	300		250		PPRS0300	1STQ008585A0000	1/1
Rubber cover	350		300		PPRS0350	1STQ008586A0000	1/1
Rubber cover	400		350		PPRS0400	1STQ008587A0000	1/1
Rubber cover	450		400		PPRS0450	1STQ008588A0000	1/1
Rubber cover	500		450		PPRS0500	1STQ008589A0000	1/1
Rubber cover	600		550		PPRS0600	1STQ008590A0000	1/1

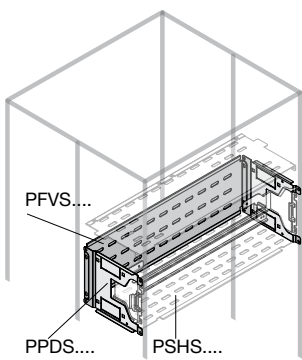

Segregation of modular assemblies

The code refers to two side walls. The segregation must be completed by ordering a front segregation and two PSHS... universal shelves, above and below. For structures with intermediate uprights.

Description	Dimensions (mm)		Order code	ABB code	Package/ No. pcs
	H	W			
No.2 Side closing elements for DIN rail	200		PPDS0200	1STQ009080A0000	1/2
Front segregation	200	400	PFVS2042	1STQ008539A0000	1/1
Front segregation	200	600	PFVS2062	1STQ008540A0000	1/1
Front segregation	200	800	PFVS2082	1STQ008541A0000	1/1

The side closing elements pre-cuts for DIN rail measure H=50mm; from a rubber cover PPRS0200 it is possible to obtain 3 rubber covers for DIN rail H=50mm each.

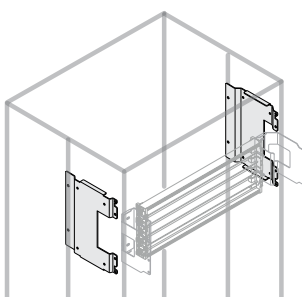

Segregation for Unifix H

Description	Dimensions (mm)		Order code	ABB code	Package/ No. pcs
	H				
No. 2 Side closing elements for Unifix H	300		PLSU0300	1STQ001333B0000	1/2

System pro E power

Order codes - Form 2a-3a segregations

E1.2 horizontal

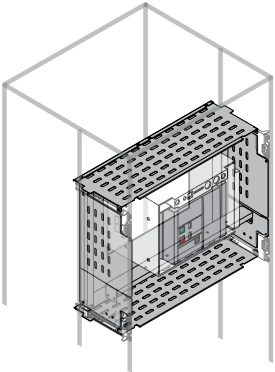

E1.2 - E2.2 - E4.2 - E6.2 vertical

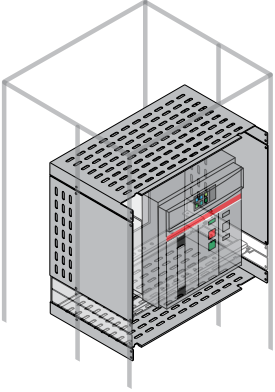

Segregation for the SACE Emax 2 circuit-breaker

The codes include two horizontal shelves, one rear plate and two side walls. For structures with intermediate uprights.

Emax 2 circuit-breaker	Version	Dimensions (mm)		Order code	ABB code	Package/ No. pcs
		H	W			
Horizontal circuit-breakers						
E1.2	W	500	600	PSHW5061 ⁽¹⁾	1STQ009281A0000	1/1
E1.2	W	500	800	PSHW5081 ⁽¹⁾	1STQ009282A0000	1/1
Vertical circuit-breakers						
E1.2	W	500	600	PSVW5061 ⁽²⁾	1STQ009055A0000	1/1
E1.2	W	500	800	PSVW5081 ⁽²⁾	1STQ009056A0000	1/1
E2.2	F	600	600	PSVF6062	1STQ009057A0000	1/1
E2.2	F	600	800	PSVF6082	1STQ009058A0000	1/1
E2.2	W	600	600	PSVW6062	1STQ009059A0000	1/1
E2.2	W	600	800	PSVW6082	1STQ009060A0000	1/1
E4.2	F	600	600	PSVF6064	1STQ009061A0000	1/1
E4.2	F	600	800	PSVF6084	1STQ009062A0000	1/1
E4.2	W	600	600	PSVW6064	1STQ009063A0000	1/1
E4.2	W	600	800	PSVW6084	1STQ009064A0000	1/1
E6.2	F	700	1000	PSVF7016	1STQ009065A0000	1/1
E6.2	F	700	1250	PSVF7126	1STQ009066A0000	1/1
E6.2	W	700	1000	PSVW7016	1STQ009067A0000	1/1
E6.2	W	700	1250	PSVW7126	1STQ009068A0000	1/1

⁽¹⁾ Also suitable for horizontal T7 withdrawable and withdrawable interlocked.

⁽²⁾ Also suitable for vertical T7 withdrawable and withdrawable interlocked.

Key:

F fixed
W withdrawable

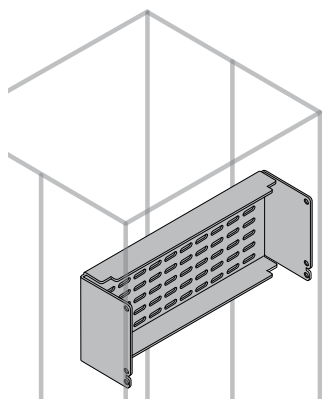

Blind compartment for segregations

Blind compartment for filling empty spaces inside the structure. The blind compartments are not suitable for fixing accessories. For structures with intermediate uprights.

Description	Dimensions (mm)		Order code	ABB code	Package/ No. pcs
	H	W			
Blind compartment	50	400	PCBS5040	1STQ008703A0000	1/1
Blind compartment	100	400	PCBS1040	1STQ008704A0000	1/1
Blind compartment	150	400	PCBS1540	1STQ008705A0000	1/1
Blind compartment	200	400	PCBS2040	1STQ008706A0000	1/1
Blind compartment	250	400	PCBS2540	1STQ008707A0000	1/1
Blind compartment	300	400	PCBS3040	1STQ009027A0000	1/1
Blind compartment	50	600	PCBS5060	1STQ008708A0000	1/1
Blind compartment	100	600	PCBS1060	1STQ008709A0000	1/1
Blind compartment	150	600	PCBS1560	1STQ008710A0000	1/1
Blind compartment	200	600	PCBS2060	1STQ008711A0000	1/1
Blind compartment	250	600	PCBS2560	1STQ008712A0000	1/1
Blind compartment	300	600	PCBS3060	1STQ009028A0000	1/1
Blind compartment	50	800	PCBS5080	1STQ008713A0000	1/1
Blind compartment	100	800	PCBS1080	1STQ008714A0000	1/1
Blind compartment	150	800	PCBS1580	1STQ008715A0000	1/1
Blind compartment	200	800	PCBS2080	1STQ008716A0000	1/1
Blind compartment	250	800	PCBS2580	1STQ008717A0000	1/1
Blind compartment	300	800	PCBS3080	1STQ009029A0000	1/1
Blind compartment	50	1000	PCBS5010	1STQ008718A0000	1/1
Blind compartment	100	1000	PCBS1010	1STQ008719A0000	1/1
Blind compartment	150	1000	PCBS1510	1STQ008720A0000	1/1
Blind compartment	200	1000	PCBS2010	1STQ008721A0000	1/1
Blind compartment	250	1000	PCBS2510	1STQ008722A0000	1/1
Blind compartment	300	1000	PCBS3010	1STQ009030A0000	1/1

System pro E power

Order codes - Busbar segregations Form 2b-3b-4b

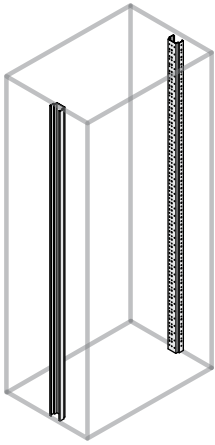

Intermediate side and rear upright for assembly of internal kits and segregations

The intermediate upright is the same as the one used for installing the kits and can be assembled both on the side and bottom of the structure.

Description	Dimensions (mm)		Order code	ABB code	Package/ No. pcs
	H				
Intermediate upright	1800		PUKI1800	1STQ008039A0000	1/1
Intermediate upright	2000		PUKI2000	1STQ008040A0000	1/1

The intermediate upright is required for all segregation Forms differing from Form 2b, even when not needed by the circuit-breaker version.

6

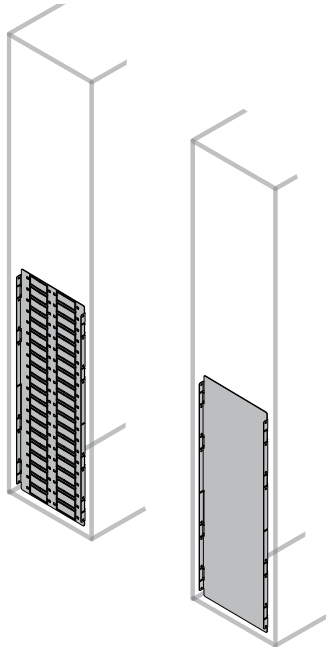

Side segregation for structure without intermediate upright

Vertical side walls for assembly between front and rear structural uprights. To use for structures with fixed circuit-breakers that do not require the intermediate upright. The precuts in the segregations are at 50mm pitch. At least three vertical ones must be removed.

Description	Dimensions (mm)		Order code	ABB code	Package/ No. pcs
	H	D			
Precut					
Precut vertical side segregation	800	200	PTVS8020	1STQ009070A0000	1/1
Precut vertical side segregation	1000	200	PTVS1020	1STQ009071A0000	1/1
Precut vertical side segregation	800	300	PTVS8030	1STQ008487A0000	1/1
Precut vertical side segregation	1000	300	PTVS1030	1STQ008488A0000	1/1
Precut vertical side segregation	800	500	PTVS8050	1STQ008489A0000	1/1
Precut vertical side segregation	1000	500	PTVS1050	1STQ008490A0000	1/1
Precut vertical side segregation	800	700	PTVS8070	1STQ008491A0000	1/1
Precut vertical side segregation	1000	700	PTVS1070	1STQ008492A0000	1/1
Blind					
Blind vertical side segregation	800	200	PTBS8020	1STQ009072A0000	1/1
Blind vertical side segregation	1000	200	PTBS1020	1STQ009073A0000	1/1
Blind vertical side segregation	800	300	PTBS8030	1STQ008493A0000	1/1
Blind vertical side segregation	1000	300	PTBS1030	1STQ008494A0000	1/1
Blind vertical side segregation	800	500	PTBS8050	1STQ008495A0000	1/1
Blind vertical side segregation	1000	500	PTBS1050	1STQ008496A0000	1/1
Blind vertical side segregation	800	700	PTBS8070	1STQ008497A0000	1/1
Blind vertical side segregation	1000	700	PTBS1070	1STQ008498A0000	1/1

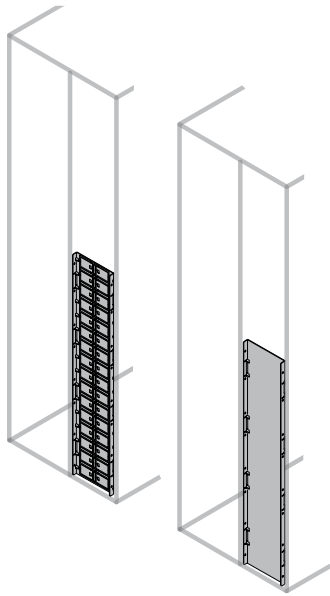

Front side segregation for structure with intermediate upright

Pre-cut vertical front side wall for assembly between intermediate upright and front structural upright.

Description	Dimensions (mm)		Order code	ABB code	Package/No. pcs
	H				
Pre-cut vertical front side segregation					
Vertical side segregation	800		PTVS8001	1STQ008511A0000	1/1
Vertical side segregation	1000		PTVS1001	1STQ008512A0000	1/1
Blind vertical front side segregation					
Vertical side segregation	800		PTBS8001	1STQ008513A0000	1/1
Vertical side segregation	1000		PTBS1001	1STQ008514A0000	1/1

Segregation Form 3b, 4b from the intermediate upright up to the front structural upright can be obtained only by means of lateral segregation closing Form 2a-3a.

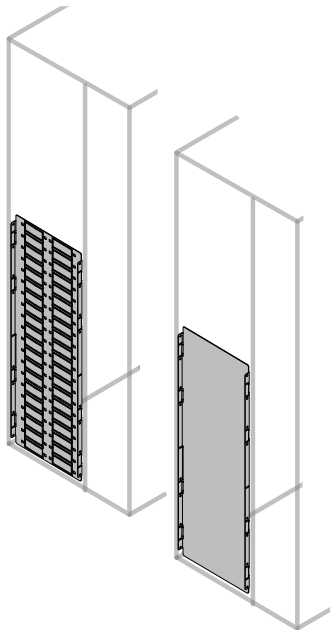

Rear side segregation for structure with intermediate upright

Pre-cut vertical rear side wall for assembly between intermediate upright and rear structural upright.

Descrizione	Dimensioni (mm)		Order code	ABB code	Package/No. pcs
	H	D			
Segregazione verticale laterale posteriore con pretranciature					
Vertical side segregation	800	500	PTVS8052	1STQ008515A0000	1/1
Vertical side segregation	1000	500	PTVS1052	1STQ008516A0000	1/1
Vertical side segregation	800	700	PTVS8072	1STQ008517A0000	1/1
Vertical side segregation	1000	700	PTVS1072	1STQ008518A0000	1/1
Vertical side segregation	800	900	PTVS8091	1STQ008519A0000	1/1
Vertical side segregation	1000	900	PTVS1091	1STQ008520A0000	1/1
Blind vertical rear side segregation					
Vertical side segregation	700	500	PLVS7052	1STQ009131A0000	1/1
Vertical side segregation	800	500	PTBS8052	1STQ008521A0000	1/1
Vertical side segregation	1000	500	PTBS1052	1STQ008522A0000	1/1
Vertical side segregation	700	700	PLVS7072	1STQ009132A0000	1/1
Vertical side segregation	800	700	PTBS8072	1STQ008523A0000	1/1
Vertical side segregation	1000	700	PTBS1072	1STQ008524A0000	1/1
Vertical side segregation	700	900	PLVS7092	1STQ009133A0000	1/1
Vertical side segregation	800	900	PTBS8091	1STQ008525A0000	1/1
Vertical side segregation	1000	900	PTVB1091	1STQ008526A0000	1/1

System pro E power

Order codes - Busbar segregations Form 2b-3b-4b

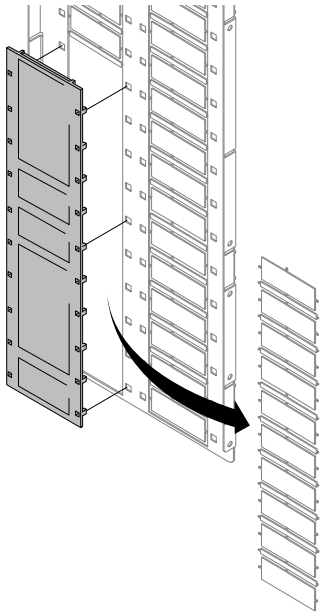

Rubber cover for precuts

Rubber cover for precut vertical segregation for routing the connections that can be installed on vertical segregations with precuts.

Description	Dimensions of rubber (mm) H	Order code	ABB code		Package/ No. pcs
Rubber cover	150	PPRS0200	1STQ008583A0000		1/1
Rubber cover	200	PPRS0250	1STQ008584A0000		1/1
Rubber cover	250	PPRS0300	1STQ008585A0000		1/1
Rubber cover	300	PPRS0350	1STQ008586A0000		1/1
Rubber cover	350	PPRS0400	1STQ008587A0000		1/1
Rubber cover	400	PPRS0450	1STQ008588A0000		1/1
Rubber cover	450	PPRS0500	1STQ008589A0000		1/1
Rubber cover	550	PPRS0600	1STQ008590A0000		1/1

For precuts H = 800mm use No. 2 rubber cover H = 400mm PPRS0450

For precuts H = 1000mm use No. 1 rubber cover H = 450mm PPRS0500 and No. 1 rubber cover H = 550mm PPRS0600

6

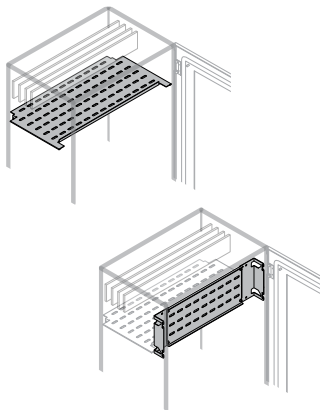

Horizontal busbar segregation in structures without intermediate upright

Form 2b

Full-width and full-depth horizontal segregations and full-width vertical segregations for routing busbars installed horizontally on the top, on the bottom, behind an empty compartment H=200mm, for structures without intermediate uprights.

Description	Dimensions (mm)			Order code	ABB code	Package/ No. pcs
	H	W	D			
Horizontal busbar shelves						
Horizontal shelf		400	300	PTHS4030	1STQ008499A0000	1/1
Horizontal shelf		400	500	PTHS4050	1STQ008500A0000	1/1
Horizontal shelf		400	700	PTHS4070	1STQ008501A0000	1/1
Horizontal shelf		600	300	PTHS6030	1STQ008502A0000	1/1
Horizontal shelf		600	500	PTHS6050	1STQ008503A0000	1/1
Horizontal shelf		600	700	PTHS6070	1STQ008504A0000	1/1
Horizontal shelf		800	300	PTHS8030	1STQ008505A0000	1/1
Horizontal shelf		800	500	PTHS8050	1STQ008506A0000	1/1
Horizontal shelf		800	700	PTHS8070	1STQ008507A0000	1/1
Front busbar segregations						
Front segregation	200	400		PFVS2040	1STQ008508A0000	1/1
Front segregation	200	600		PFVS2060	1STQ008509A0000	1/1
Front segregation	200	800		PFVS2080	1STQ008510A0000	1/1



Horizontal busbar segregation for external cable compartment without intermediate upright Form 2b

Full-width and full-depth horizontal shelves and front busbar segregations for external cable compartments.

Description	Dimensions (mm)			Order code	ABB code	Package/ No. pcs
	H	W	D			
Horizontal busbar shelves						
Horizontal shelf		300	300	PTHS3030	1STQ008547A0000	1/1
Horizontal shelf		300	500	PTHS3050	1STQ008548A0000	1/1
Horizontal shelf		300	700	PTHS3070	1STQ008549A0000	1/1
Horizontal shelf		300	900	PTHS3090	1STQ009077A0000	1/1
Horizontal shelf		400	300	PTHS4030	1STQ008499A0000	1/1
Horizontal shelf		400	500	PTHS4050	1STQ008500A0000	1/1
Horizontal shelf		400	700	PTHS4070	1STQ008501A0000	1/1
Horizontal shelf		400	900	PTHS4190	1STQ009078A0000	1/1
Front busbar segregations						
Front segregation	200	300		PFVS2130	1STQ008553A0000	1/1
Front segregation	200	400		PFVS2140	1STQ008554A0000	1/1

6

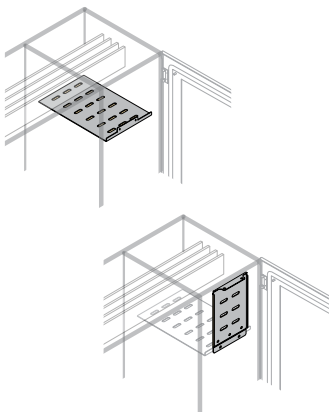

Horizontal busbar segregation for internal cable compartment without intermediate upright Form 2b

Full-width and full-depth horizontal shelves and front busbar segregations for internal cable compartments.

Description	Dimensions (mm)			Order code	ABB code	Package/ No. pcs
	H	W	D			
Horizontal busbar shelves						
Horizontal shelf		200	300	PTHS2030	1STQ008565A0000	1/1
Horizontal shelf		200	500	PTHS2050	1STQ008566A0000	1/1
Horizontal shelf		200	700	PTHS2070	1STQ008567A0000	1/1
Horizontal shelf		200	900	PTHS2090	1STQ009079A0000	1/1
Horizontal shelf		400	300	PTHS4230	1STQ008568A0000	1/1
Horizontal shelf		400	500	PTHS4250	1STQ008569A0000	1/1
Horizontal shelf		400	700	PTHS4270	1STQ008570A0000	1/1
Horizontal shelf		400	900	PTHS4290	1STQ009081A0000	1/1
Front busbar segregations						
Front segregation	200	300		PFVS2220	1STQ008571A0000	1/1
Front segregation	200	400		PFVS2240	1STQ008572A0000	1/1

System pro E power

Order codes - Busbar segregations Form 2b-3b-4b

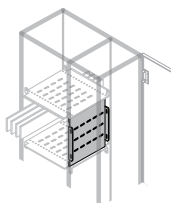
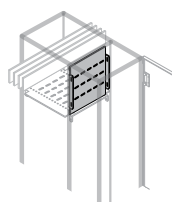
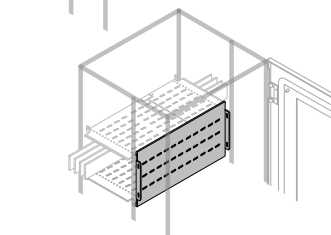
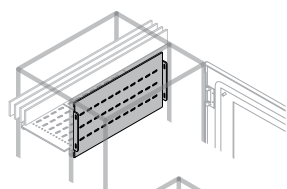
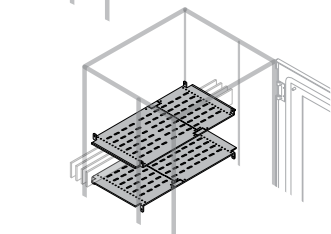
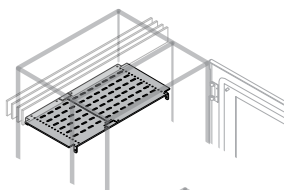

Horizontal busbar segregation in structures with intermediate upright

Horizontal shelves and front segregations for routing busbars installed horizontally on the top, on the bottom and at each heights. The busbar area can be 200 or 300mm in height.

Description	Dimensions (mm)			Order code	ABB code	Package/ No. pcs
	H	W	D			
Horizontal shelves for busbars under the top, on the bottom and at each heights						
Horizontal shelf		400	500	PTHS4052	1STQ008527A0000	1/1
Horizontal shelf		600	500	PTHS6052	1STQ008528A0000	1/1
Horizontal shelf		800	500	PTHS8052	1STQ008529A0000	1/1
Horizontal shelf		1000	500	PTHS1052	1STQ008530A0000	1/1
Horizontal shelf		400	700	PTHS4072	1STQ008531A0000	1/1
Horizontal shelf		600	700	PTHS6072	1STQ008532A0000	1/1
Horizontal shelf		800	700	PTHS8072	1STQ008533A0000	1/1
Horizontal shelf		1000	700	PTHS1072	1STQ008534A0000	1/1
Horizontal shelf		400	900	PTHS4092	1STQ008535A0000	1/1
Horizontal shelf		600	900	PTHS6092	1STQ008536A0000	1/1
Horizontal shelf		800	900	PTHS8092	1STQ008537A0000	1/1
Horizontal shelf		1000	900	PTHS1092	1STQ008538A0000	1/1
Horizontal shelf		1250	900	PTHS1292*	1STQ009074A0000	1/1
Front segregation for busbars under the top, on the bottom and at each heights						
Front segregation	200	400		PFVS2042	1STQ008539A0000	1/1
Front segregation	200	600		PFVS2062	1STQ008540A0000	1/1
Front segregation	200	800		PFVS2082	1STQ008541A0000	1/1
Front segregation	200	1000		PFVS2012	1STQ008542A0000	1/1
Front segregation	200	1250		PFVS2122	1STQ009075A0000	1/1
Front segregation	300	400		PFVS3042	1STQ008543A0000	1/1
Front segregation	300	600		PFVS3062	1STQ008544A0000	1/1
Front segregation	300	800		PFVS3082	1STQ008545A0000	1/1
Front segregation	300	1000		PFVS3012	1STQ008546A0000	1/1
Front segregation	300	1250		PFVS3122	1STQ009076A0000	1/1

Busbars at each heights can be used only for segregation forms different from Form 2b.

Horizontal busbar segregation in external cable compartment with intermediate upright

Full-width rear horizontal shelves and front busbar segregations for assembly between intermediate upright and structural rear upright in external cable compartments.

Description	Dimensions (mm)			Order code	ABB code	Package/ No. pcs
	H	W	D			
Horizontal shelves for busbars under the top, on the bottom and at each heights						
Horizontal shelf		300	500	PTHS3052	1STQ008555A0000	1/1
Horizontal shelf		300	700	PTHS3072	1STQ008556A0000	1/1
Horizontal shelf		300	900	PTHS3092	1STQ008557A0000	1/1
Horizontal shelf		400	500	PTHS4152	1STQ008558A0000	1/1
Horizontal shelf		400	700	PTHS4172	1STQ008559A0000	1/1
Horizontal shelf		400	900	PTHS4192	1STQ008560A0000	1/1
Front segregation for busbars under the top, on the bottom and at each heights						
Front segregation	200	300		PFVS2132	1STQ008561A0000	1/1
Front segregation	200	400		PFVS2042	1STQ008539A0000	1/1
Front segregation	300	300		PFVS3132	1STQ008563A0000	1/1
Front segregation	300	400		PFVS3042	1STQ008543A0000	1/1

Busbars at each heights can be used only for segregation forms different from Form 2b.

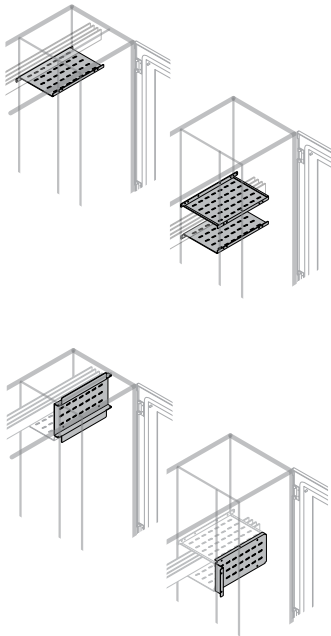

Horizontal busbar segregation in internal cable compartments with intermediate upright

Full-width rear segregation for horizontal busbars. Assembly between intermediate upright and structural rear upright.

Description	Dimensions (mm)		Order code	ABB code	Package/ No. pcs
	W	D			
Horizontal shelves for busbars under the top, on the bottom and at each heights					
Horizontal shelf	200	500	PTHS2052	1STQ008573A0000	1/1
Horizontal shelf	200	700	PTHS2072	1STQ008574A0000	1/1
Horizontal shelf	200	900	PTHS2092	1STQ008575A0000	1/1
Horizontal shelf	400	500	PTHS4252	1STQ008576A0000	1/1
Horizontal shelf	400	700	PTHS4272	1STQ008577A0000	1/1
Horizontal shelf	400	900	PTHS4292	1STQ008578A0000	1/1
Description	Dimensions (mm)		Order code	ABB code	Package/ No. pcs
	H	W			
Front rear segregation for busbars under the top or on the bottom					
Front segregation	200	200	PFVS2222	1STQ008579A0000	1/1
Front segregation	200	400	PFVS2242	1STQ008580A0000	1/1
Front segregation	300	200	PFVS3222	1STQ008581A0000	1/1
Front segregation	300	400	PFVS3242	1STQ008582A0000	1/1
Front rear segregation for busbars at each heights					
Front segregation	200	200	PFVS2223	1STQ009082A0000	1/1
Front segregation	200	400	PFVS2243	1STQ009083A0000	1/1
Front segregation	300	200	PFVS3223	1STQ009084A0000	1/1
Front segregation	300	400	PFVS3243	1STQ009085A0000	1/1

Busbars at each heights can be used only for segregation forms different from Form 2b.

System pro E power

Order codes - Form 3b segregations

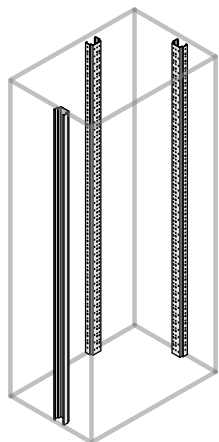

Intermediate side and rear upright for assembly of internal kits and segregations

The intermediate upright is the same as the one used for installing the kits and can be assembled both on the side and bottom of the structure. The intermediate upright is necessary for horizontal breakers in Form 3b.

Description	Dimensions (mm)	Order code	ABB code	Package/ No. pcs
	H			
Intermediate upright	1800	PUKI1800	1STQ008039A0000	1/1
Intermediate upright	2000	PUKI2000	1STQ008040A0000	1/1

6

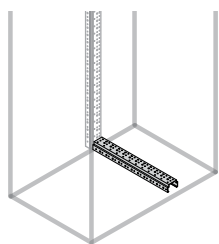

Intermediate crosspiece for rear intermediate uprights

The intermediate crosspiece is necessary only for horizontal breakers in order to assemble terminal segregations when the breakers is installed in the first available position in the structure (under the roof) or in the last available position of the structure (bottom).

Description	Dimensions (mm)	Order code	ABB code	Package/ No. pcs
	D			
Intermediate crosspiece	500	PCIS0500	1STQ009165A0000	1/1
Intermediate crosspiece	700	PCIS0700	1STQ009166A0000	1/1
Intermediate crosspiece	900	PCIS0900	1STQ009167A0000	1/1

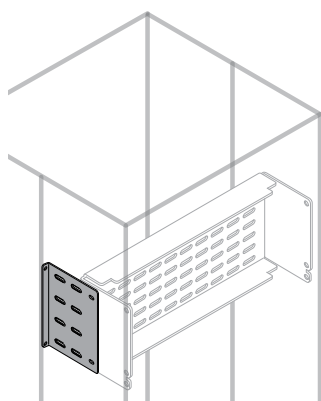

Side wall for input side. For blind compartment

To assemble from front upright to intermediate upright.

Description	Dimensions (mm)	Order code	ABB code	Package/ No. pcs
	H			
Side wall for blind compartment	50	PPBS0050	1STQ009168A0000	1/1
Side wall for blind compartment	100	PPBS0100	1STQ009169A0000	1/1
Side wall for blind compartment	150	PPBS0150	1STQ001230B0000	1/1
Side wall for blind compartment	200	PPBS0200	1STQ009170A0000	1/1
Side wall for blind compartment	250	PPBS0250	1STQ009171A0000	1/1
Side wall for blind compartment	300	PPBS0300	1STQ009172A0000	1/1

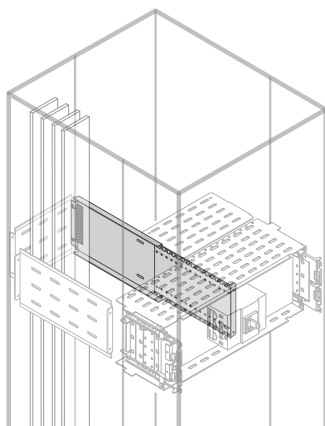

Horizontal circuit-breaker segregation in structures with intermediate rear upright

Rear vertical segregation with sliding plate at the same height as the circuit-breaker compartment. Assembly between the input and output terminals for horizontal circuit-breakers, from plate to rear intermediate upright.

Description	Dimensions (mm)		Order code	ABB code	Package/ No. pcs
	H	D			
Vertical terminal separator	200	500	PSVS2050	1STQ008727A0000	1/1
Vertical terminal separator	250	500	PSVS2550	1STQ008728A0000	1/1
Vertical terminal separator	300	500	PSVS3050	1STQ008729A0000	1/1
Vertical terminal separator	350	500	PSVS3550	1STQ008730A0000	1/1
Vertical terminal separator	400	500	PSVS4050	1STQ008731A0000	1/1
Vertical terminal separator	500	500	PSVS5050	1STQ008733A0000	1/1
Vertical terminal separator	500	700	PSVS0055*	1STQ009160A0000	1/1
Vertical terminal separator	600	500	PSVS6050	1STQ008734A0000	1/1
Vertical terminal separator	200	700	PSVS2070	1STQ008735A0000	1/1
Vertical terminal separator	250	700	PSVS2570	1STQ008736A0000	1/1
Vertical terminal separator	300	700	PSVS3070	1STQ008737A0000	1/1
Vertical terminal separator	350	700	PSVS3570	1STQ008738A0000	1/1
Vertical terminal separator	400	700	PSVS4070	1STQ008739A0000	1/1
Vertical terminal separator	500	700	PSVS5070	1STQ008741A0000	1/1
Vertical terminal separator	500	900	PSVS0057*	1STQ009161A0000	1/1
Vertical terminal separator	600	700	PSVS6070	1STQ008742A0000	1/1
Vertical terminal separator	200	900	PSVS2090	1STQ008743A0000	1/1
Vertical terminal separator	250	900	PSVS2590	1STQ008744A0000	1/1
Vertical terminal separator	300	900	PSVS3090	1STQ008745A0000	1/1
Vertical terminal separator	350	900	PSVS3590	1STQ008746A0000	1/1
Vertical terminal separator	400	900	PSVS4090	1STQ008747A0000	1/1
Vertical terminal separator	500	900	PSVS5090	1STQ008749A0000	1/1
Vertical terminal separator	600	900	PSVS6090	1STQ008750A0000	1/1

*For Tmax T7 and Emax E1.2 W and W - I

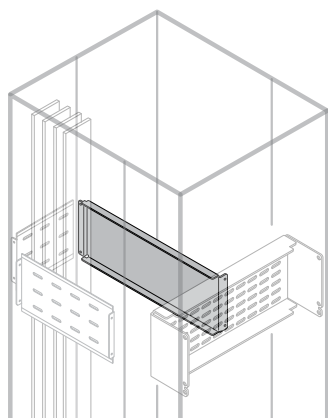

Rear segregation for blind compartment

Rear vertical segregation with plate for blind compartment.

Description	Dimensions (mm)		Order code	ABB code	Package/ No. pcs
	H	D			
Rear vertical separator blind compartment	50	500	PSVS0505	1STQ009086A0000	1/1
Rear vertical separator blind compartment	100	500	PSVS0105	1STQ009087A0000	1/1
Rear vertical separator blind compartment	150	500	PSVS0155	1STQ009088A0000	1/1
Rear vertical separator blind compartment	200	500	PSVS0205	1STQ009089A0000	1/1
Rear vertical separator blind compartment	250	500	PSVS0255	1STQ009090A0000	1/1
Rear vertical separator blind compartment	300	500	PSVS0305	1STQ009091A0000	1/1
Rear vertical separator blind compartment	50	700	PSVS0507	1STQ009092A0000	1/1
Rear vertical separator blind compartment	100	700	PSVS0107	1STQ009093A0000	1/1
Rear vertical separator blind compartment	150	700	PSVS0157	1STQ009094A0000	1/1
Rear vertical separator blind compartment	200	700	PSVS0207	1STQ009095A0000	1/1
Rear vertical separator blind compartment	250	700	PSVS0257	1STQ009096A0000	1/1
Rear vertical separator blind compartment	300	700	PSVS0307	1STQ009097A0000	1/1
Rear vertical separator blind compartment	50	900	PSVS0509	1STQ009098A0000	1/1
Rear vertical separator blind compartment	100	900	PSVS0109	1STQ009099A0000	1/1
Rear vertical separator blind compartment	150	900	PSVS0159	1STQ009100A0000	1/1
Rear vertical separator blind compartment	200	900	PSVS0209	1STQ009101A0000	1/1
Rear vertical separator blind compartment	250	900	PSVS0259	1STQ009102A0000	1/1
Rear vertical separator blind compartment	300	900	PSVS0309	1STQ009103A0000	1/1

System pro E power

Order codes - Form 3b segregations

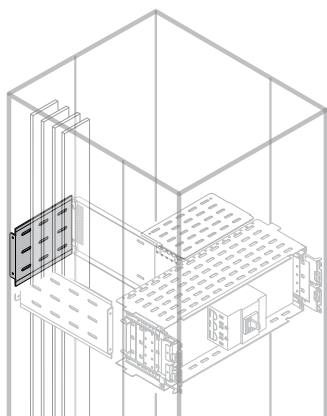

Segregation for busbar side of horizontal circuit-breaker in structures with intermediate rear upright

Vertical rear bottom segregation with height equal to the compartment height and width equal to the distance between intermediate rear upright and structural rear upright on the busbar side.

Description	Dimensions (mm)		Order code	ABB code	Package/ No. pcs
	H	W			
Segregation bottom busbar side	200	400	PRVS2041	1STQ008765A0000	1/1
Segregation bottom busbar side	250	400	PRVS2541	1STQ008767A0000	1/1
Segregation bottom busbar side	300	400	PRVS3041	1STQ008768A0000	1/1
Segregation bottom busbar side	350	400	PRVS3541	1STQ008769A0000	1/1
Segregation bottom busbar side	400	400	PRVS4041	1STQ008770A0000	1/1
Segregation bottom busbar side	500	400	PRVS5041	1STQ008772A0000	1/1
Segregation bottom busbar side	600	400	PRVS6041	1STQ008773A0000	1/1
Segregation bottom busbar side	700	400	PRVS7041	1STQ009122A0000	1/1
Segregation bottom busbar side	200	600	PRVS2061	1STQ008775A0000	1/1
Segregation bottom busbar side	250	600	PRVS2561	1STQ008777A0000	1/1
Segregation bottom busbar side	300	600	PRVS3061	1STQ008778A0000	1/1
Segregation bottom busbar side	350	600	PRVS3561	1STQ008779A0000	1/1
Segregation bottom busbar side	400	600	PRVS4061	1STQ008780A0000	1/1
Segregation bottom busbar side	500	600	PRVS5061	1STQ008782A0000	1/1
Segregation bottom busbar side	600	600	PRVS6061	1STQ008783A0000	1/1
Segregation bottom busbar side	700	600	PRVS7061	1STQ009125A0000	1/1
Segregation bottom busbar side	200	800	PRVS2081	1STQ008785A0000	1/1
Segregation bottom busbar side	250	800	PRVS2581	1STQ008787A0000	1/1
Segregation bottom busbar side	300	800	PRVS3081	1STQ008788A0000	1/1
Segregation bottom busbar side	350	800	PRVS3581	1STQ008789A0000	1/1
Segregation bottom busbar side	400	800	PRVS4081	1STQ008790A0000	1/1
Segregation bottom busbar side	500	800	PRVS5081	1STQ008792A0000	1/1
Segregation bottom busbar side	600	800	PRVS6081	1STQ008793A0000	1/1
Segregation bottom busbar side	700	800	PRVS7081	1STQ009128A0000	1/1

For the closing of consecutive compartments it is possible to use the segregations at each height page 6/42.

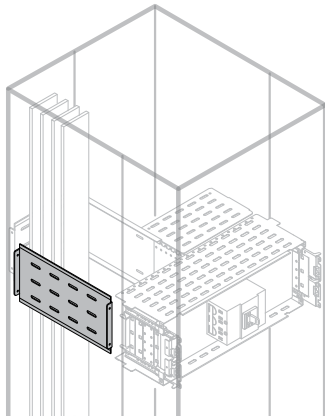

Side segregations for horizontal circuit-breakers in structures with intermediate upright and rear structural upright

Vertical rear side segregation with height equal to circuit-breaker compartment height. Assembly between intermediate upright and rear structural upright. H=800mm or H=1000mm segregations can be used as alternatives. When the installation of the busbars fixing crosspieces is needed with side segregations, use the PBBT0008 fixing brackets.

Description	Dimensions (mm)		Order code	ABB code	Package/ No. pcs
	H	D			
Side compartment segregation	200	500	PLVS2052	1STQ008886A0000	1/1
Side compartment segregation	250	500	PLVS2552	1STQ008888A0000	1/1
Side compartment segregation	300	500	PLVS3052	1STQ008889A0000	1/1
Side compartment segregation	350	500	PLVS3552	1STQ008890A0000	1/1
Side compartment segregation	400	500	PLVS4052	1STQ008891A0000	1/1
Side compartment segregation	500	500	PLVS5052	1STQ008893A0000	1/1
Side compartment segregation	600	500	PLVS6052	1STQ008894A0000	1/1
Side compartment segregation	200	700	PLVS2072	1STQ008896A0000	1/1
Side compartment segregation	250	700	PLVS2572	1STQ008898A0000	1/1
Side compartment segregation	300	700	PLVS3072	1STQ008899A0000	1/1
Side compartment segregation	350	700	PLVS3572	1STQ008900A0000	1/1
Side compartment segregation	400	700	PLVS4072	1STQ008901A0000	1/1
Side compartment segregation	500	700	PLVS5072	1STQ008903A0000	1/1
Side compartment segregation	600	700	PLVS6072	1STQ008904A0000	1/1
Side compartment segregation	200	900	PLVS2092	1STQ008906A0000	1/1
Side compartment segregation	250	900	PLVS2592	1STQ008908A0000	1/1
Side compartment segregation	300	900	PLVS3092	1STQ008909A0000	1/1
Side compartment segregation	350	900	PLVS3592	1STQ008910A0000	1/1
Side compartment segregation	400	900	PLVS4092	1STQ008911A0000	1/1
Side compartment segregation	500	900	PLVS5092	1STQ008913A0000	1/1
Side compartment segregation	600	900	PLVS6092	1STQ008914A0000	1/1

For the closing of consecutive compartments it is possible to use the segregations at each height page 6/42.

System pro E power

Order codes - Form 3b segregations

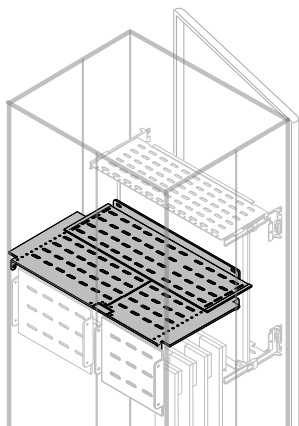

Vertical circuit-breaker segregation in structures with or without intermediate rear upright

Horizontal rear segregation to fix behind plate as wide as the structure. In sheet metal for moulded-case Tmax T, XT and E1.2 fixed circuit-breakers. Useful for separating the terminals in vertical circuit-breakers. Pre-engineered for the presence/absence of an intermediate rear upright.

Description	Dimensions (mm)		Order code	ABB code	Package/ No. pcs
	W	D			
Horizontal terminal separator	400	500	PSHS4050	1STQ008751A0000	1/1
Horizontal terminal separator	600	500	PSHS6050	1STQ008752A0000	1/1
Horizontal terminal separator	800	500	PSHS8050	1STQ008753A0000	1/1
Horizontal terminal separator	400	700	PSHS4070	1STQ008755A0000	1/1
Horizontal terminal separator	600	700	PSHS6070	1STQ008756A0000	1/1
Horizontal terminal separator	800	700	PSHS8070	1STQ008757A0000	1/1
Horizontal terminal separator	400	900	PSHS4090	1STQ008759A0000	1/1
Horizontal terminal separator	600	900	PSHS6090	1STQ008760A0000	1/1
Horizontal terminal separator	800	900	PSHS8090	1STQ008761A0000	1/1

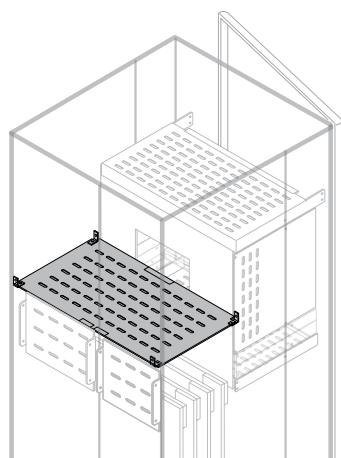

Segregation for SACE Emax2 vertical circuit-breakers in structures with or without intermediate upright

Emax 2 circuit-breaker	Version	Dimensions (mm)		Order code	ABB code	Package/ No. pcs
		W	D			
E1.2	W	600	500	PSHW6051 ⁽¹⁾	1STQ009031A0000	1/1
E1.2	W	600	700	PSHW6071 ⁽¹⁾	1STQ009032A0000	1/1
E1.2	W	600	900	PSHW6091	1STQ009917A0000	1/1
E1.2	W	800	500	PSHW8051 ⁽¹⁾	1STQ009033A0000	1/1
E1.2	W	800	700	PSHW8071 ⁽¹⁾	1STQ009034A0000	1/1
E1.2	W	800	900	PSHW8091	1STQ009918A0000	1/1
E2.2	F	600	700	PSHF6072	1STQ009035A0000	1/1
E2.2	F	600	900	PSHF6092	1STQ009036A0000	1/1
E2.2	F	800	700	PSHF8072	1STQ009037A0000	1/1
E2.2	F	800	900	PSHF8092	1STQ009038A0000	1/1
E2.2	W	600	700	PSHW6072	1STQ009039A0000	1/1
E2.2	W	600	900	PSHW6092	1STQ009040A0000	1/1
E2.2	W	800	700	PSHW8072	1STQ009041A0000	1/1
E2.2	W	800	900	PSHW8092	1STQ009042A0000	1/1
E4.2	F	600	700	PSHF6072	1STQ009035A0000	1/1
E4.2	F	600	900	PSHF6092	1STQ009036A0000	1/1
E4.2	F	800	700	PSHF8072	1STQ009037A0000	1/1
E4.2	F	800	900	PSHF8092	1STQ009038A0000	1/1
E4.2	W	600	700	PSHW6074	1STQ009047A0000	1/1
E4.2	W	600	900	PSHW6094	1STQ009048A0000	1/1
E4.2	W	800	700	PSHW8074	1STQ009049A0000	1/1
E4.2	W	800	900	PSHW8094	1STQ009050A0000	1/1
E6.2	F	1000	900	PSHF1096	1STQ009051A0000	1/1
E6.2	F	1250	900	PSHF1296	1STQ009052A0000	1/1
E6.2	W	1000	900	PSHW1096	1STQ009053A0000	1/1
E6.2	W	1250	900	PSHW1296	1STQ009054A0000	1/1

⁽¹⁾ Also suitable for vertical T7 withdrawable and withdrawable interlocked.

System pro E power

Order codes - Form 3b segregations

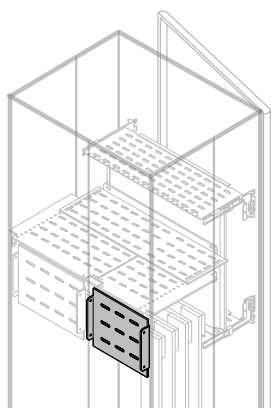

Vertical circuit-breaker segregation (segregation on busbar side) for fixed/interlocked T5, T6, T7 and E1.2 in structures with intermediate rear uprights

Vertical rear bottom segregation with height equal to half the compartment height and width equal to the distance between intermediate rear upright and structural rear upright on the busbar side.

Description	Dimensions (mm)		Order code	ABB code	Package/ No. pcs
	H	W			
Segregation on bottom busbar side	175	400	PRVS1741	1STQ008764A0000	1/1
Segregation on bottom busbar side	200	400	PRVS2041	1STQ008765A0000	1/1
Segregation on bottom busbar side	225	400	PRVS2241	1STQ008766A0000	1/1
Segregation on bottom busbar side	300	400	PRVS3041	1STQ008768A0000	1/1
Segregation on bottom busbar side	175	600	PRVS1761	1STQ008774A0000	1/1
Segregation on bottom busbar side	200	600	PRVS2061	1STQ008775A0000	1/1
Segregation on bottom busbar side	225	600	PRVS2261	1STQ008776A0000	1/1
Segregation on bottom busbar side	250	600	PRVS2561	1STQ008777A0000	1/1
Segregation on bottom busbar side	300	600	PRVS3061	1STQ008778A0000	1/1
Segregation on bottom busbar side	175	800	PRVS1781	1STQ008784A0000	1/1
Segregation on bottom busbar side	200	800	PRVS2081	1STQ008785A0000	1/1
Segregation on bottom busbar side	225	800	PRVS2251	1STQ008786A0000	1/1
Segregation on bottom busbar side	250	800	PRVS2581	1STQ008787A0000	1/1
Segregation on bottom busbar side	300	800	PRVS3081	1STQ008788A0000	1/1

For the closing of consecutive compartments it is possible to use the segregations at each height page 6/42.

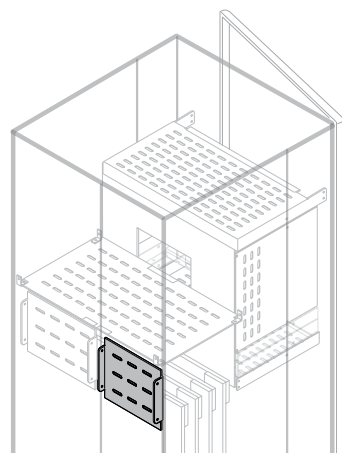

Vertical circuit-breaker segregation (segregation on busbar side) for Emax air circuit-breakers in structures with intermediate rear uprights

Vertical rear bottom segregation with height equal to half the compartment height and width equal to the distance between intermediate rear upright and structural rear upright on the busbar side.

Description	Dimensions (mm)		Order code	ABB code	Package/ No. pcs
	H	W			
Segregation on bottom busbar side	300	400	PRVS3041	1STQ008768A0000	1/1
Segregation on bottom busbar side	250	600	PRVS2561	1STQ008777A0000	1/1
Segregation on bottom busbar side	300	600	PRVS3061	1STQ008778A0000	1/1
Segregation on bottom busbar side	250	800	PRVS2581	1STQ008787A0000	1/1
Segregation on bottom busbar side	300	800	PRVS3081	1STQ008788A0000	1/1

For the closing of consecutive compartments it is possible to use the segregations at each height page 6/42.

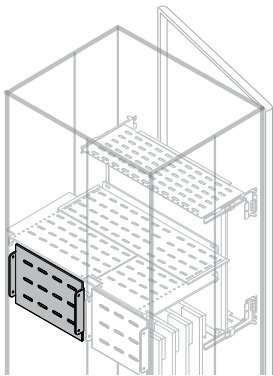

Vertical circuit-breaker segregation (segregation on output side) for fixed/interlocked T5, T6, T7 and E1.2 in structures with intermediate rear uprights

Vertical rear bottom segregation with height equal to half the compartment height and width equal to the distance between intermediate rear upright and structural rear upright on the output side.

Description	Dimensions (mm)		Order code	ABB code	Package/ No. pcs
	H	W			
Segregation on bottom output side	175	600	PRVS1762	1STQ008814A0000	1/1
Segregation on bottom output side	200	600	PRVS2062	1STQ008815A0000	1/1
Segregation on bottom output side	225	600	PRVS2262	1STQ008816A0000	1/1
Segregation on bottom output side	250	600	PRVS2562	1STQ008817A0000	1/1
Segregation on bottom output side	175	800	PRVS1782	1STQ008824A0000	1/1
Segregation on bottom output side	200	800	PRVS2082	1STQ008825A0000	1/1
Segregation on bottom output side	225	800	PRVS2282	1STQ008826A0000	1/1
Segregation on bottom output side	250	800	PRVS2582	1STQ008827A0000	1/1

For the closing of consecutive compartments it is possible to use the segregations at each height page 6/43.

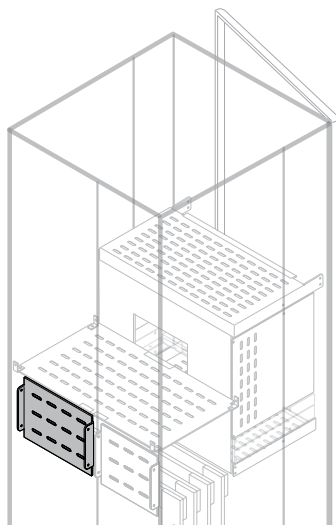

Vertical circuit-breaker segregation (segregation on output side) for SACE Emax 2 air circuit-breakers in structures with intermediate rear uprights

Vertical rear bottom segregation with height equal to half the compartment height and width equal to the distance between intermediate rear upright and structural rear upright on the output side.

Description	Dimensions (mm)		Order code	ABB code	Package/ No. pcs
	H	W			
Segregation on bottom output side	250	600	PRVS2562	1STQ008817A0000	1/1
Segregation on bottom output side	300	600	PRVS3062	1STQ008818A0000	1/1
Segregation on bottom output side	250	800	PRVS2582	1STQ008827A0000	1/1
Segregation on bottom output side	300	800	PRVS3082	1STQ008828A0000	1/1

For the closing of consecutive compartments it is possible to use the segregations at each height page 6/43.

System pro E power

Order codes - Form 3b segregations

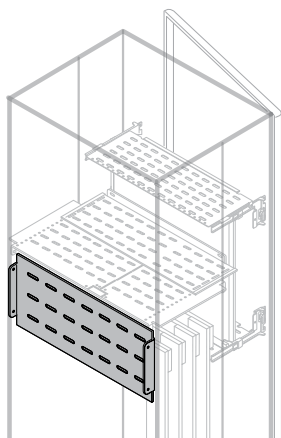

Segregation for vertical fixed/interlocked T5, T6, T7 and E1.2 circuit-breakers in structures without intermediate upright.

Vertical rear bottom segregation with height equal to half the compartment height and full-width.

Description	Dimensions (mm)		Order code	ABB code	Package/ No. pcs
	H	W			
Full-width segregation on bottom	175	400	PRVS1740	1STQ008844A0000	1/1
Full-width segregation on bottom	200	400	PRVS2040	1STQ008845A0000	1/1
Full-width segregation on bottom	225	400	PRVS2240	1STQ008846A0000	1/1
Full-width segregation on bottom	175	600	PRVS1760	1STQ008854A0000	1/1
Full-width segregation on bottom	200	600	PRVS2060	1STQ008855A0000	1/1
Full-width segregation on bottom	225	600	PRVS2260	1STQ008856A0000	1/1
Full-width segregation on bottom	250	600	PRVS2560	1STQ008857A0000	1/1
Full-width segregation on bottom	300	600	PRVS3060	1STQ008858A0000	1/1
Full-width segregation on bottom	175	800	PRVS1780	1STQ008864A0000	1/1
Full-width segregation on bottom	200	800	PRVS2080	1STQ008865A0000	1/1
Full-width segregation on bottom	225	800	PRVS2280	1STQ008866A0000	1/1
Full-width segregation on bottom	250	800	PRVS2580	1STQ008867A0000	1/1
Full-width segregation on bottom	300	800	PRVS3080	1STQ008868A0000	1/1
Full-width segregation on bottom	175	1000	PRVS1710	1STQ008874A0000	1/1
Full-width segregation on bottom	200	1000	PRVS2010	1STQ008875A0000	1/1
Full-width segregation on bottom	225	1000	PRVS2210	1STQ008876A0000	1/1
Full-width segregation on bottom	250	1000	PRVS2510	1STQ008877A0000	1/1
Full-width segregation on bottom	350	1000	PRVS3510	1STQ008879A0000	1/1
Full-width segregation on bottom	200	1250	PRVS2125	1STQ009139A0000	1/1
Full-width segregation on bottom	250	1250	PRVS2512	1STQ008837A0000	1/1

For the closing of consecutive compartments it is possible to use the segregations at each height page 6/43.

6

Segregation for SACE Emax2 vertical air circuit-breakers in structures without intermediate rear upright

Vertical rear bottom segregation with height equal to half the compartment height and full-width.

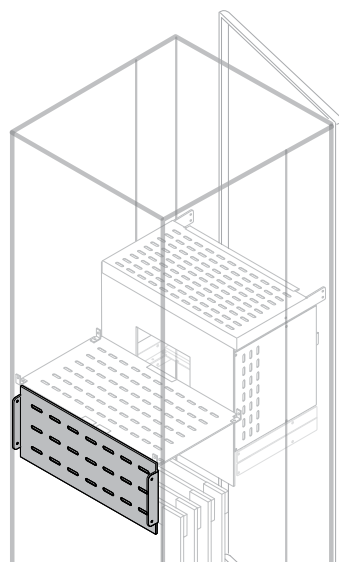

Description	Dimensions (mm)		Order code	ABB code	Package/ No. pcs
	H	W			
Full-width vertical segregation on bottom	250	600	PRVS2560	1STQ008857A0000	1/1
Full-width vertical segregation on bottom	300	600	PRVS3060	1STQ008858A0000	1/1
Full-width vertical segregation on bottom	250	800	PRVS2580	1STQ008867A0000	1/1
Full-width vertical segregation on bottom	300	800	PRVS3080	1STQ008868A0000	1/1
Full-width vertical segregation on bottom	250	1000	PRVS2510	1STQ008877A0000	1/1
Full-width vertical segregation on bottom	300	1000	PRVS3010	1STQ008878A0000	1/1
Full-width vertical segregation on bottom	350	1000	PRVS3510	1STQ008879A0000	1/1
Full-width vertical segregation on bottom	250	1250	PRVS2512	1STQ008837A0000	1/1
Full-width vertical segregation on bottom	300	1250	PRVS3125	1STQ008884A0000	1/1
Full-width vertical segregation on bottom	350	1250	PRVS3501	1STQ009141A0000	1/1

For the closing of consecutive compartments it is possible to use the segregations at each height page 6/43.

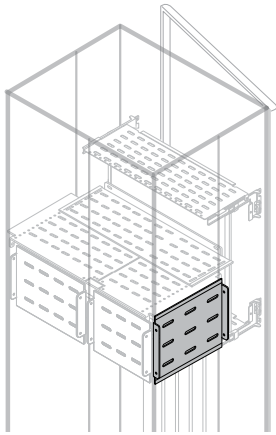

Segregation for vertical fixed/interlocked T5, T6, T7 and E1.2 circuit-breakers with intermediate upright and structural rear upright.

Vertical side segregation with height equal to half the circuit-breaker compartment height. Assembly between intermediate upright and structural rear upright. H=800mm or H=1000mm segregations can be used.

Description	Dimensions (mm)		Order code	ABB code	Package/ No. pcs
	H	D			
Side compartment segregation	175	500	PLVS1752	1STQ008885A0000	1/1
Side compartment segregation	200	500	PLVS2052	1STQ008886A0000	1/1
Side compartment segregation	225	500	PLVS2252	1STQ008887A0000	1/1
Side compartment segregation	250	500	PLVS2552	1STQ008888A0000	1/1
Side compartment segregation	175	700	PLVS1772	1STQ008895A0000	1/1
Side compartment segregation	200	700	PLVS2072	1STQ008896A0000	1/1
Side compartment segregation	225	700	PLVS2272	1STQ008897A0000	1/1
Side compartment segregation	250	700	PLVS2572	1STQ008898A0000	1/1
Side compartment segregation	175	900	PLVS1792	1STQ008905A0000	1/1
Side compartment segregation	200	900	PLVS2092	1STQ008906A0000	1/1
Side compartment segregation	225	900	PLVS2292	1STQ008907A0000	1/1
Side compartment segregation	250	900	PLVS2592	1STQ008908A0000	1/1

For the closing of consecutive compartments it is possible to use the segregations at each height page 6/42.

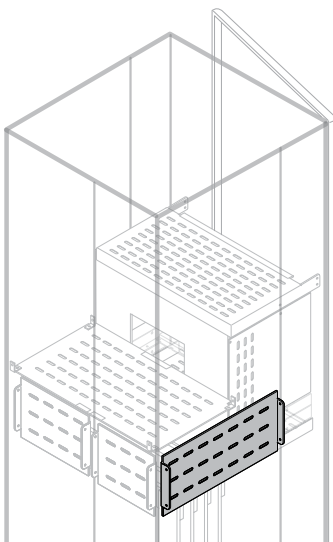

Segregation for SACE Emax 2 vertical air circuit-breaker in structures with intermediate upright and rear structural upright

Vertical side segregation with height equal to half the circuit-breaker compartment height. Assembly between intermediate upright and rear structural upright. H=800mm or H=1000mm segregations can be used.

Description	Dimensions (mm)		Order code	ABB code	Package/ No. pcs
	H	D			
Side compartment segregation	250	500	PLVS2552	1STQ008888A0000	1/1
Side compartment segregation	300	500	PLVS3052	1STQ008889A0000	1/1
Side compartment segregation	350	500	PLVS3552	1STQ008890A0000	1/1
Side compartment segregation	250	700	PLVS2572	1STQ008898A0000	1/1
Side compartment segregation	300	700	PLVS3072	1STQ008899A0000	1/1
Side compartment segregation	350	700	PLVS3572	1STQ008900A0000	1/1
Side compartment segregation	250	900	PLVS2592	1STQ008908A0000	1/1
Side compartment segregation	300	900	PLVS3092	1STQ008909A0000	1/1
Side compartment segregation	350	900	PLVS3592	1STQ008910A0000	1/1

For the closing of consecutive compartments it is possible to use the segregations at each height page 6/42.

System pro E power

Order codes - Form 3b segregations

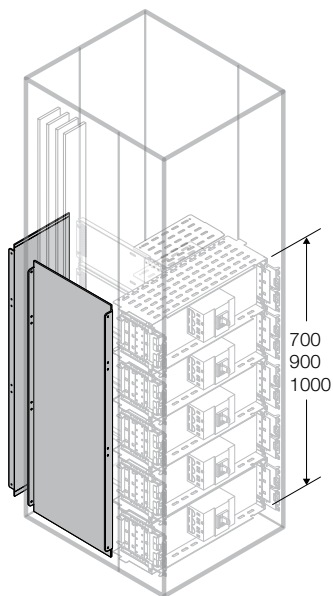

Vertical segregations at each height

To be used in alternative to (rear and side) cells vertical segregations, with different breakers combined together up to H=700-800-1000mm.

Description	Dimensions (mm)		Order code	ABB code	Package/ No. pcs
	H	W			
Vertical segregations at each height busbars side					
Segregation at each height busbars side	700	400	PRVS7041	1STQ009122A0000	1/1
Segregation at each height busbars side	800	400	PRVS8041	1STQ009123A0000	1/1
Segregation at each height busbars side	1000	400	PRVS1041	1STQ009124A0000	1/1
Segregation at each height busbars side	700	600	PRVS7061	1STQ009125A0000	1/1
Segregation at each height busbars side	800	600	PRVS8061	1STQ009126A0000	1/1
Segregation at each height busbars side	1000	600	PRVS1061	1STQ009127A0000	1/1
Segregation at each height busbars side	700	800	PRVS7081	1STQ009128A0000	1/1
Segregation at each height busbars side	800	800	PRVS8081	1STQ009129A0000	1/1
Segregation at each height busbars side	1000	800	PRVS1081	1STQ009130A0000	1/1

Description	Dimensions (mm)		Order code	ABB code	Package/ No. pcs
	H	D			
Vertical side segregations at each height					
Side segregation at each height	700	500	PLVS7052	1STQ009131A0000	1/1
Side segregation at each height	800	500	PTBS8052	1STQ008521A0000	1/1
Side segregation at each height	1000	500	PTBS1052	1STQ008522A0000	1/1
Side segregation at each height	700	700	PLVS7072	1STQ009132A0000	1/1
Side segregation at each height	800	700	PTBS8072	1STQ008523A0000	1/1
Side segregation at each height	1000	700	PTBS1072	1STQ008524A0000	1/1
Side segregation at each height	700	900	PLVS7092	1STQ009133A0000	1/1
Side segregation at each height	800	900	PTBS8091	1STQ008525A0000	1/1
Side segregation at each height	1000	900	PTVB1091	1STQ008526A0000	1/1

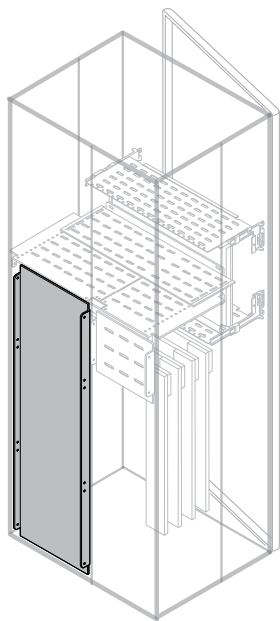

Vertical circuit-breaker segregation in structures with intermediate rear upright

Vertical rear segregation 700/800/1000mm in height and width equal to the distance between intermediate upright and structural rear upright on the output side.

Description	Dimensions (mm)		Order code	ABB code	Package/ No. pcs
	H	W			
Rear segregation output side	700	600	PRVS7062	1STQ009104A0000	1/1
Rear segregation output side	800	600	PRVS8062	1STQ009105A0000	1/1
Rear segregation output side	1000	600	PRVS1062	1STQ009106A0000	1/1
Rear segregation output side	700	800	PRVS7082	1STQ009107A0000	1/1
Rear segregation output side	800	800	PRVS8082	1STQ009108A0000	1/1
Rear segregation output side	1000	800	PRVS1082	1STQ009109A0000	1/1

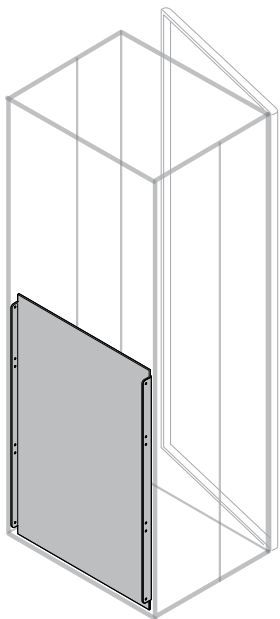

Full-width vertical segregation on bottom

Full-width vertical rear segregation on bottom for structures without intermediate rear upright.

Description	Dimensions (mm)		Order code	ABB code	Package/ No. pcs
	H	W			
Full-width segregation on bottom	700	400	PRVS7040	1STQ009110A0000	1/1
Full-width segregation on bottom	800	400	PRVS8040	1STQ009111A0000	1/1
Full-width segregation on bottom	1000	400	PRVS1040	1STQ009112A0000	1/1
Full-width segregation on bottom	700	600	PRVS7060	1STQ009113A0000	1/1
Full-width segregation on bottom	800	600	PRVS8060	1STQ009114A0000	1/1
Full-width segregation on bottom	1000	600	PRVS1060	1STQ009115A0000	1/1
Full-width segregation on bottom	700	800	PRVS7080	1STQ009116A0000	1/1
Full-width segregation on bottom	800	800	PRVS8080	1STQ009117A0000	1/1
Full-width segregation on bottom	1000	800	PRVS1080	1STQ009118A0000	1/1
Full-width segregation on bottom	700	1000	PRVS7010	1STQ009119A0000	1/1
Full-width segregation on bottom	800	1000	PRVS8010	1STQ009120A0000	1/1
Full-width segregation on bottom	1000	1000	PRVS1010	1STQ009121A0000	1/1

System pro E power

Order codes - Form 3b segregations

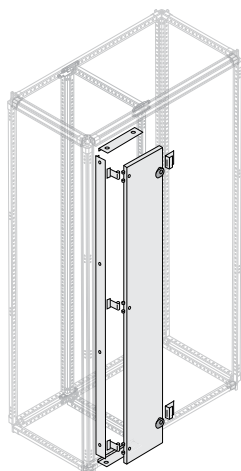

Internal door for internal cable compartment – Pickled steel sheet

Internal door in pickled steel sheet for cable compartment IP30.

Description	Dimensions (mm)		Order code	ABB code	Package/ No.pcs
	H	W			
Blind door for internal cable compartment	1800	200	PDCB1820	1STQ007753A0000	1/1
Blind door for internal cable compartment	1800	400	PDCB1840	1STQ007754A0000	1/1
Blind door for internal cable compartment	2000	200	PDCB2020	1STQ007755A0000	1/1
Blind door for internal cable compartment	2000	400	PDCB2040	1STQ007756A0000	1/1

6

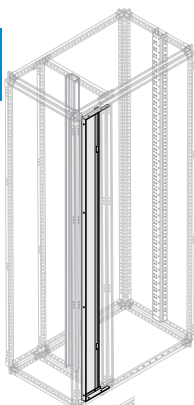

Vertical front segregation for internal cable compartment

To be used in IP3X protection degree enclosures Form 2a-3a or in segregated enclosures from Form 3b.

Description	Dimensions (mm)		Order code	ABB code	Package/ No.pcs
	H	W			
Vertical front segregation	1800	200	PFBS8020	1STQ001481B0000	1/1
Vertical front segregation	1800	400	PFBS8040	1STQ001483B0000	1/1
Vertical front segregation	2000	200	PFBS1020	1STQ001482B0000	1/1
Vertical front segregation	2000	400	PFBS1040	1STQ001484B0000	1/1

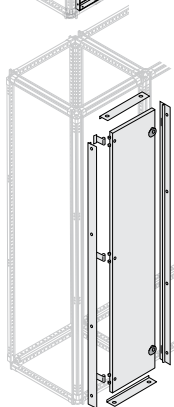

Internal door for external cable compartment – Pickled steel sheet

Internal door in pickled steel sheet for cable compartment IP30.

Description	Dimensions (mm)		Order code	ABB code	Package/ No.pcs
	H	W			
Blind door for external cable compartment	1800	300	PDCB1830	1STQ008086A0000	1/1
Blind door for external cable compartment	1800	400	PDCB1844	1STQ008087A0000	1/1
Blind door for external cable compartment	2000	300	PDCB2030	1STQ008088A0000	1/1
Blind door for external cable compartment	2000	400	PDCB2044	1STQ008089A0000	1/1

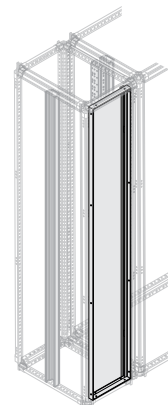

Vertical front segregation for external cable compartment

To be used in IP3X protection degree enclosures Form 2a-3a or in segregated enclosures from Form 3b.

Description	Dimensions (mm)		Order code	ABB code	Package/ No.pcs
	H	W			
Vertical front segregation	1800	300	PFVS8030	1STQ001485B0000	1/1
Vertical front segregation	1800	400	PFVS8040	1STQ001487B0000	1/1
Vertical front segregation	2000	300	PFVS1030	1STQ001486B0000	1/1
Vertical front segregation	2000	400	PFVS1040	1STQ001488B0000	1/1

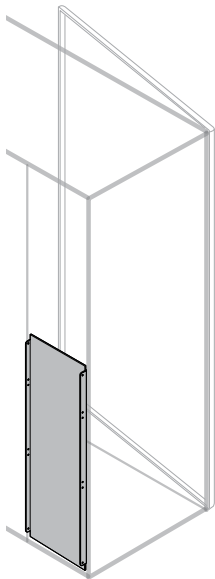

Internal cable compartment segregation

Blind rear vertical segregation for internal cable compartment.

Description	Dimensions (mm)		Order code	ABB code	Package/ No. pcs
	H	W			
Vertical rear segregation	800	200	PRBS8220	1STQ008915A0000	1/1
Vertical rear segregation	1000	200	PRBS1220	1STQ008916A0000	1/1
Vertical rear segregation	800	400	PRBS8240	1STQ008919A0000	1/1
Vertical rear segregation	1000	400	PRBS1240	1STQ008920A0000	1/1

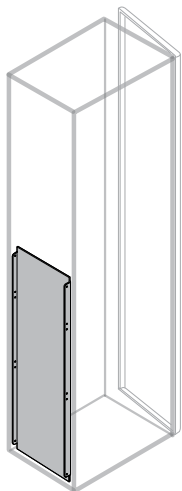

Rear segregation for external cable compartment

Blind rear vertical segregation for external cable compartment.

Description	Dimensions (mm)		Order code	ABB code	Package/ No. pcs
	H	W			
Vertical rear segregation	800	300	PRVS8062	1STQ009105A0000	1/1
Vertical rear segregation	1000	300	PRVS1062	1STQ009106A0000	1/1
Vertical rear segregation	800	400	PRVS8040	1STQ009111A0000	1/1
Vertical rear segregation	1000	400	PRVS1040	1STQ009112A0000	1/1

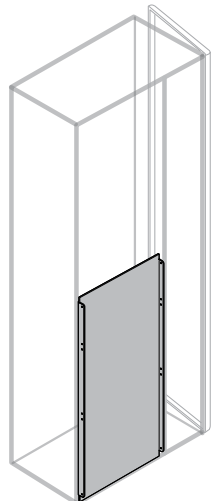

Side segregation for external cable compartment

Blind side segregation for external cable compartment.

Description	Dimensions (mm)		Order code	ABB code	Package/ No. pcs
	H	D			
Vertical side segregation	700	500	PLVS7052	1STQ009131A0000	1/1
Vertical side segregation	800	500	PTBS8052	1STQ008521A0000	1/1
Vertical side segregation	1000	500	PTBS1052	1STQ008522A0000	1/1
Vertical side segregation	700	700	PLVS7072	1STQ009132A0000	1/1
Vertical side segregation	800	700	PTBS8072	1STQ008523A0000	1/1
Vertical side segregation	1000	700	PTBS1072	1STQ008524A0000	1/1
Vertical side segregation	700	900	PLVS7092	1STQ009133A0000	1/1
Vertical side segregation	800	900	PTBS8091	1STQ008525A0000	1/1
Vertical side segregation	1000	900	PTVB1091	1STQ008526A0000	1/1

System pro E power

Order codes - Form 4b segregations

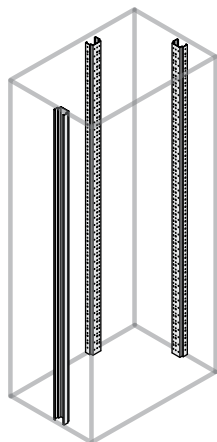

Intermediate side and rear upright for assembly of internal kits and segregations

The intermediate upright is the same as the one used for installing the kits and can be assembled both on the side and bottom of the structure. The rear intermediate upright is necessary in order to mount the segregations for horizontal breakers.

Description	Dimensions (mm) H	Order code	ABB code	Package/ No. pcs
Intermediate upright	1800	PUKI1800	1STQ008039A0000	1/1
Intermediate upright	2000	PUKI2000	1STQ008040A0000	1/1

Use universal vertical shelf PSHS.... for each compartment in order to reach Form 4b.

6

Position P0

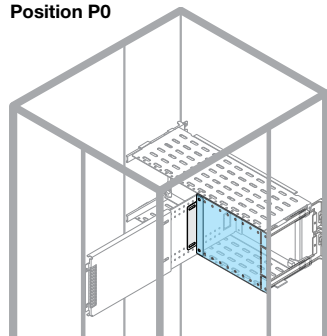

Choice of segregation to suit depth of circuit-breaker

For segregation 4b, choose kits corresponding to the depth of each circuit-breaker in the required version, as indicated in the tables below.

Horizontal circuit-breakers with front terminals

Circuit-breaker version	XT1	XT2	XT3	XT4	T4	T5	T6	T7	E1.2
Fixed	P0	P0	P0	P0	P0	P0	P0	P0	P0
Fixed with direct crank handle (RHD)	P0	P0	P0	P0	P0	P0	P0	P0	P0
Fixed with motor operator (MO)	P0	P0	P0	P0				P0	
Fixed interlocked	P0	P0	P0	P0	P0	P0	P0	P0	P0
Fixed interlocked motor-operated								P0	

Position P1

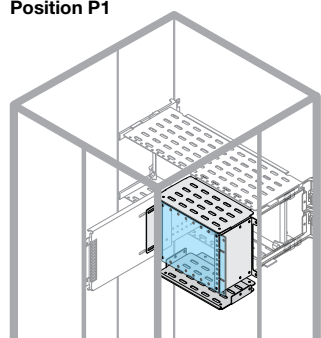

Horizontal circuit-breakers with rear terminals

Circuit-breaker version	XT1	XT2	XT3	XT4	T4	T5	T6	T7	E1.2
Fixed	P0	P0	P0	P0	P1	P1	P1	P1	P1
Fixed with direct crank handle (RHD)	P1	P1	P1	P1	P1	P1	P1	P1	P1
Fixed with motor operator (MO)	P1	P1	P1	P1				P1	
Fixed interlocked								P1	
Fixed interlocked motor-operated								P1	
Plug-in	P0	P1	P1	P1		P1			
Plug-in with direct crank handle (RHD)	P1	P1	P1	P1		P1			
Plug-in with motor operator (MO)									
Plug-in interlocked									
Plug-in interlocked motor-operated									
Withdrawable		P1		P1		P1	P1	■	■
Withdrawable with direct crank handle (RHD)		P1		P1		P1	P1	■	■
Withdrawable with motor operator (MO)									
Withdrawable interlocked									
Withdrawable interlocked motor-operated									

■ See codes on page 6/16.

Position P2

The P2 segregations can replace the P0 and P1 segregation in order to obtain more useful space available inside the compartment.

Position P2

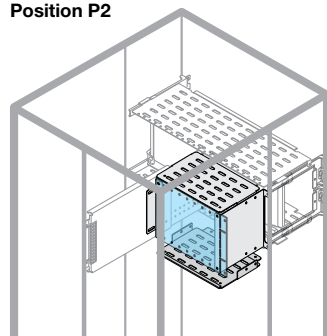

Position P0

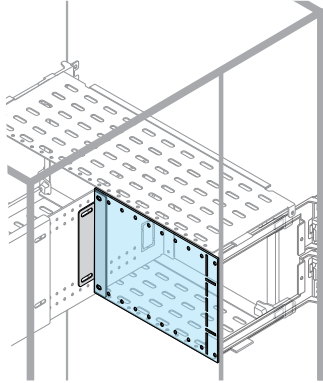

Segregation for horizontal circuit-breakers in position 0

Sheet metal corner piece to fix to separator PSVS... With vertical Lexan panel at compartment height.

Description	Assembly position	Dimensions (mm)		Order code	ABB code	Package/ No. pcs
		H	W			
Corner piece and panel in Lexan	P0	200	400	PCVS0204	1STQ008931A0000	1/1
Corner piece and panel in Lexan	P0	250	400	PCVS0254	1STQ008932A0000	1/1
Corner piece and panel in Lexan	P0	300	400	PCVS0304	1STQ008933A0000	1/1
Corner piece and panel in Lexan	P0	350	400	PCVS0354	1STQ008934A0000	1/1
Corner piece and panel in Lexan	P0	400	400	PCVS0404	1STQ008935A0000	1/1
Corner piece and panel in Lexan	P0	500	400	PCVS0504	1STQ008937A0000	1/1
Corner piece and panel in Lexan	P0	600	400	PCVS0604	1STQ008938A0000	1/1
Corner piece and panel in Lexan	P0	200	600	PCVS0206	1STQ008939A0000	1/1
Corner piece and panel in Lexan	P0	250	600	PCVS0256	1STQ008940A0000	1/1
Corner piece and panel in Lexan	P0	300	600	PCVS0306	1STQ008941A0000	1/1
Corner piece and panel in Lexan	P0	350	600	PCVS0356	1STQ008942A0000	1/1
Corner piece and panel in Lexan	P0	400	600	PCVS0406	1STQ008943A0000	1/1
Corner piece and panel in Lexan	P0	500	600	PCVS0506	1STQ008945A0000	1/1
Corner piece and panel in Lexan	P0	600	600	PCVS0606	1STQ008946A0000	1/1
Corner piece and panel in Lexan	P0	200	800	PCVS0208	1STQ008947A0000	1/1
Corner piece and panel in Lexan	P0	250	800	PCVS0258	1STQ008948A0000	1/1
Corner piece and panel in Lexan	P0	300	800	PCVS0308	1STQ008949A0000	1/1
Corner piece and panel in Lexan	P0	350	800	PCVS0358	1STQ008950A0000	1/1
Corner piece and panel in Lexan	P0	400	800	PCVS0408	1STQ008951A0000	1/1
Corner piece and panel in Lexan	P0	500	800	PCVS0508	1STQ008953A0000	1/1
Corner piece and panel in Lexan	P0	600	800	PCVS0608	1STQ008954A0000	1/1

Position P1

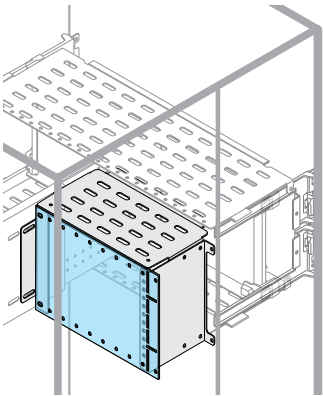

Segregation for horizontal circuit-breakers in position 1

Sheet metal corner piece to fix on separator PSVS... With vertical Lexan panel at compartment height, horizontal shelf and side wall.

Description	Assembly position	Dimensions (mm)		Order code	ABB code	Package/ No. pcs
		H	W			
Rear cubicle	P1	200	400	PCVS1204	1STQ008963A0000	1/1
Rear cubicle	P1	250	400	PCVS1254	1STQ008964A0000	1/1
Rear cubicle	P1	300	400	PCVS1304	1STQ008965A0000	1/1
Rear cubicle	P1	350	400	PCVS1354	1STQ008966A0000	1/1
Rear cubicle	P1	400	400	PCVS1404	1STQ008967A0000	1/1
Rear cubicle	P1	500	400	PCVS1504	1STQ008969A0000	1/1
Rear cubicle	P1	600	400	PCVS1604	1STQ008970A0000	1/1
Rear cubicle	P1	200	600	PCVS1206	1STQ008971A0000	1/1
Rear cubicle	P1	250	600	PCVS1256	1STQ008972A0000	1/1
Rear cubicle	P1	300	600	PCVS1306	1STQ008973A0000	1/1
Rear cubicle	P1	350	600	PCVS1356	1STQ008974A0000	1/1
Rear cubicle	P1	400	600	PCVS1406	1STQ008975A0000	1/1
Rear cubicle	P1	500	600	PCVS1506	1STQ008977A0000	1/1
Rear cubicle	P1	600	600	PCVS1606	1STQ008978A0000	1/1
Rear cubicle	P1	200	800	PCVS1208	1STQ008979A0000	1/1
Rear cubicle	P1	250	800	PCVS1258	1STQ008980A0000	1/1
Rear cubicle	P1	300	800	PCVS1308	1STQ008981A0000	1/1
Rear cubicle	P1	350	800	PCVS1358	1STQ008982A0000	1/1
Rear cubicle	P1	400	800	PCVS1408	1STQ008983A0000	1/1
Rear cubicle	P1	500	800	PCVS1508	1STQ008985A0000	1/1
Rear cubicle	P1	600	800	PCVS1608	1STQ008986A0000	1/1

System pro E power

Order codes - Form 4b segregations

Position P2

The P2 segregations can replace the P0 and P1 segregation in order to obtain more useful space available inside the compartment.

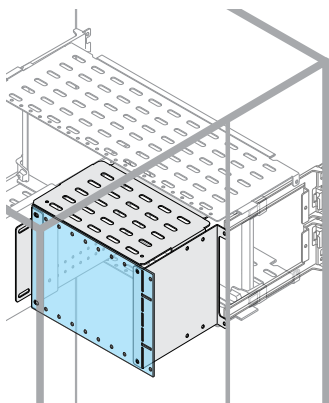

6

Segregation for horizontal circuit-breakers in position 2

Sheet metal corner piece to fix on separator PSVS.... With vertical Lexan panel at compartment height, horizontal shelf and side wall.

Description	Assembly position	Dimensions (mm)		Order code	ABB code	Package/ No. pcs
		H	W			
Rear cubicle	P2	200	400	PCVS2204	1STQ008995A0000	1/1
Rear cubicle	P2	250	400	PCVS2254	1STQ008996A0000	1/1
Rear cubicle	P2	300	400	PCVS2304	1STQ008997A0000	1/1
Rear cubicle	P2	350	400	PCVS2354	1STQ008998A0000	1/1
Rear cubicle	P2	400	400	PCVS2404	1STQ008999A0000	1/1
Rear cubicle	P2	500	400	PCVS2504	1STQ009001A0000	1/1
Rear cubicle	P2	600	400	PCVS2604	1STQ009002A0000	1/1
Rear cubicle	P2	200	600	PCVS2206	1STQ009003A0000	1/1
Rear cubicle	P2	250	600	PCVS2256	1STQ009004A0000	1/1
Rear cubicle	P2	300	600	PCVS2306	1STQ009005A0000	1/1
Rear cubicle	P2	350	600	PCVS2356	1STQ009006A0000	1/1
Rear cubicle	P2	400	600	PCVS2406	1STQ009007A0000	1/1
Rear cubicle	P2	500	600	PCVS2506	1STQ009009A0000	1/1
Rear cubicle	P2	600	600	PCVS2606	1STQ009010A0000	1/1
Rear cubicle	P2	200	800	PCVS2208	1STQ009011A0000	1/1
Rear cubicle	P2	250	800	PCVS2258	1STQ009012A0000	1/1
Rear cubicle	P2	300	800	PCVS2308	1STQ009013A0000	1/1
Rear cubicle	P2	350	800	PCVS2358	1STQ009014A0000	1/1
Rear cubicle	P2	400	800	PCVS2408	1STQ009015A0000	1/1
Rear cubicle	P2	500	800	PCVS2508	1STQ009017A0000	1/1
Rear cubicle	P2	600	800	PCVS2608	1STQ009018A0000	1/1

Segregation for horizontal withdrawable Emax E1.2 and Tmax T7 circuit-breakers

The code includes corner piece, vertical Lexan panel, 2 horizontal shelves and side wall.

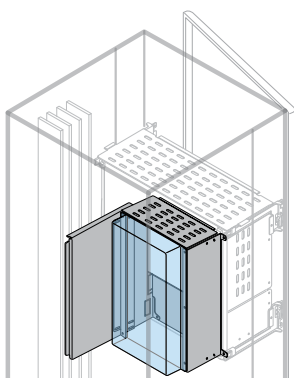

Description	Dimensions (mm)		Order code	ABB code	Package/ No. pcs
	H	W			
Rear cubicle	500	600	PCVS5060	1STQ009162A0000	1/1
Rear cubicle	500	800	PCVS5080	1STQ009163A0000	1/1

Horizontal segregation for cubicles

Horizontal shelf for cubicles for 4b segregation. Required for all depth changes in compartments in the same column. Order the length corresponding to the larger position between two consecutive compartments.

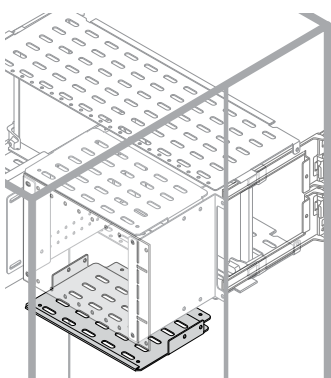

Description	Assembly position	Dimensions (mm)		Order code	ABB code	Package/ No. pcs
		W	H			
Horizontal shelf for cubicles	P1	400	400	PSHS1400	1STQ008923A0000	1/1
Horizontal shelf for cubicles	P1	600	400	PSHS1600	1STQ008924A0000	1/1
Horizontal shelf for cubicles	P1	800	400	PSHS1800	1STQ008925A0000	1/1
Horizontal shelf for cubicles	P2	400	600	PSHS2400	1STQ008927A0000	1/1
Horizontal shelf for cubicles	P2	600	600	PSHS2600	1STQ008928A0000	1/1
Horizontal shelf for cubicles	P2	800	600	PSHS2800	1STQ008929A0000	1/1

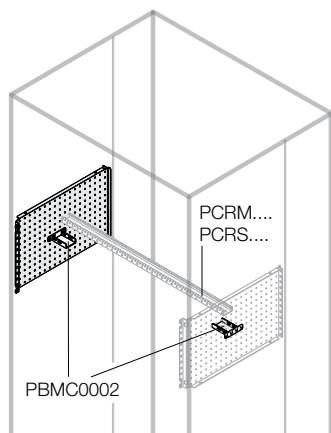

Lateral connection module for terminal ditching

Lateral drilled module 25mm pitch for fixing the crosspieces with insulating supports in width from the intermediate upright up to the rear structural upright. In order to complete the terminals ditching it is necessary to order two lateral connection modules, which have to be fixed sideways. The crosspieces PCRM or PCRS is fixed using the special fixing brackets for module connection PBMC0002. The crosspiece is to be chosen and ordered separately according to the width of the structure.

Description	H (mm)	D (mm)	Order code	ABB code	Package/ No. pcs
Lateral connection module	175	500	PMCS1755	1STQ009200A0000	1/1
Lateral connection module	200	500	PMCS2050	1STQ009201A0000	1/1
Lateral connection module	225	500	PMCS2255	1STQ009202A0000	1/1
Lateral connection module	250	500	PMCS2550	1STQ009203A0000	1/1
Lateral connection module	300	500	PMCS3050	1STQ009204A0000	1/1
Lateral connection module	175	700	PMCS1757	1STQ009205A0000	1/1
Lateral connection module	200	700	PMCS2070	1STQ009206A0000	1/1
Lateral connection module	225	700	PMCS2257	1STQ009207A0000	1/1
Lateral connection module	250	700	PMCS2570	1STQ009208A0000	1/1
Lateral connection module	300	700	PMCS3070	1STQ009209A0000	1/1
Lateral connection module	175	900	PMCS1759	1STQ009210A0000	1/1
Lateral connection module	200	900	PMCS2090	1STQ009211A0000	1/1
Lateral connection module	225	900	PMCS2259	1STQ009212A0000	1/1
Lateral connection module	250	900	PMCS2590	1STQ009213A0000	1/1
Lateral connection module	300	900	PMCS3090	1STQ009214A0000	1/1
No.2 fixing brackets connection module			PBMC0002	1STQ009215A0000	1/2

Segregations for vertical circuit-breakers

Form 4b of vertical circuit-breakers is obtained by duplicating the codes of vertical bottom segregations PRVS... and vertical side segregations PLVS..., closing the circuit-breaker compartments for the full height of the switchboard and installing an additional vertical side segregation on the output side.

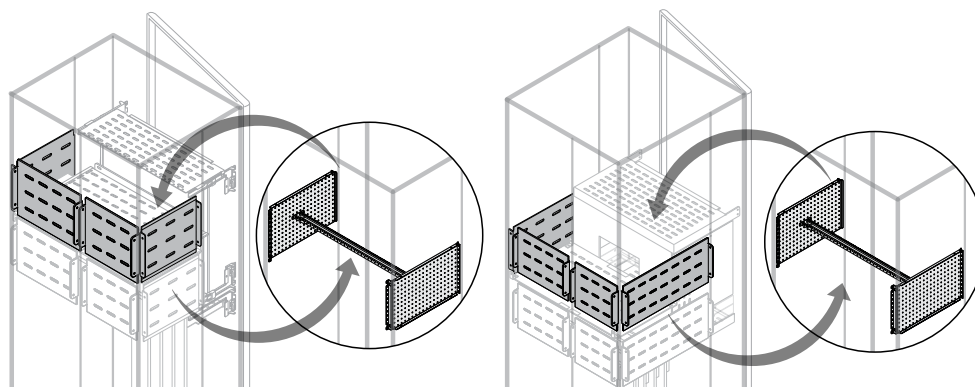

As an alternative to the PLVS... vertical side segregations, in the case of main circuit-breakers, use the PMCS... side connection module for fixing terminal extensions and the relative fixing bshelfets PBMC0002 (page 4/40).

System pro *E* power

Technical details and certifications

Mechanical and electrical characteristics	7/2
Declaration of conformity	7/4
Power dissipated	7/5
Handling	7/10
Electrical continuity	7/12
Calculation of protection conductor PE	7/13
Equipotential conductors	7/14
Mechanical shock resistance IK	7/15
Protection classes	7/16
Unifix wiring system	
Connection examples - Unifix H	7/18
Connection examples - Unifix L	7/19
Configurations	
Configuration examples	7/20

System pro E power

Technical details and certifications

Mechanical and electrical characteristics

Conformity to Standard IEC 61439-1-2

System pro E power switchboards are subjected in the ABB laboratories, to the type tests established by Standard IEC 61439-1-2. The results of these tests guarantee the performance of System pro E power switchboards and when ABB SACE structures, air circuit-breakers, moulded-case and modular circuit-breakers are used, relieve the end manufacturer of the switchboard from having to perform further type tests so long as he/it complies with the selection criteria and assembly instructions for the various different components. Reference can be made to these results, described below, when drawing up the declaration of conformity of the switchboard.

Overtemperature (Ref. sect. 9.2. of the Standard)

Values from the type tests performed referring to all System pro E - Power switchboard sizes and to the type of installation are given in the tables. The dissipated power data (in Watts) depend on the allowable overtemperature inside the upper part of the switchboard and should be compared with the sum of the powers dissipated by all the components installed in the switchboard (also taking the coincidence factor into due account).

Dielectric properties (Ref. sect. 10.9. of the Standard)

Rated service voltage	up to 1000V AC / 1500V DC
Rated insulation voltage	up to 1000V AC / 1500V DC
Rated impulse withstand voltage	8kV / 12kV

Short-circuit withstand capacity (Ref. sect. 10.11. of the Standard)

Rated short-time short-circuit current:	line-to-line	120kA (1s) 50kA (3s)
	line-to-neutral	72kA (1s)
Rated max. peak short-circuit current		264kA

Protection against the circuit and short-circuit withstand (Ref. sect. 9.3. of the Standard)

Rated admissible short-time withstand current I _{cw} for the protection circuit	72kA (1s)
--	-----------

Insulation clearances (Ref. sect. 10.4. of the Standard)

Insulation clearances are guaranteed when the assembly instructions provided with the ABB SACE structures and circuit-breakers are complied with.

Mechanical operation (Ref. sect. 10.13. of the Standard)

When the assembly instructions of the ABB SACE structures are circuit-breakers are complied with, mechanical operation can be considered as verified.

Protection class (Ref. sect. 10.3 of the Standard)

Protection class obtained with respect to the type of panelling	Front sealing profiles	Door	Rear	Side panels	Top	Bottom	Top profile
Blind							
IP30	● *	-	● *	● *	● *	● *	-
IP31	● *	-	● *	● *	● *	● *	● *
IP40	-	● *	● *	● *	● *	● *	-
IP41	-	● *	● *	● *	● *	● *	● *
IP65	-	●	●	●	●	●	-
Vented							
IP30	● *	-	● **	● **	● *	● *	-
IP31	● *	-	● **	● **	● *	● *	● *
IP40	-	● *	● ***	● ***	● *	● *	-
IP41	-	● *	● ***	● ***	● *	● *	● *

* Codes in the catalogue allowing IP30-IP31 protection class to be obtained for structures without doors, IP40-IP41 for structures with doors. The structures change from IP30 to IP31 if the top sealing kits are used in addition to the front sealing profiles. The structures change from IP40 to IP41 if the top sealing kits are used in addition to the doors.

** Codes in the catalogue for vented panels allowing IP30-31 protection class to be obtained for structures without doors. The structures change from IP30 to IP31 if the top sealing kits are used in addition to the front sealing profiles.

*** Codes in the catalogue for vented panels allowing IP30-31 protection class to be obtained for structures without doors. The structures change from IP30 to IP40 adding the door and the grates for vented panel. The structures change from IP30 to IP31 if the top sealing kits are used in addition to the front sealing profiles. The structures change from IP40 to IP41 if the top sealing kits are used in addition to the doors.

Mechanical specifications

Material		
Uprights and cross-pieces		12/10mm hot-dip galvanized sheet steel
		12/10mm AISI 304 stainless steel
Plinth angle pieces		25/10mm hot-dip galvanized sheet steel
Plinth flanges		15/10mm hot-dip galvanized sheet steel
External panels		pickled steel sheet thickness 8/10mm for IP30/40 and 15/10 for IP65
Doors		15/10mm thick pickled sheet steel. 4mm thick toughened glass glued from the inside
Plates		15/10mm hot-dip galvanized sheet steel
Panels		12/10mm pickled steel sheet
Partitions		plastic components: thermoplastic vulcanizate metal components: 15/10mm pickled steel sheet
Paint coating		
Structure colour		RAL 7035 grey orange peel finish
Plinth colour		RAL 7012 grey orange peel finish
Standard cycle		The sheet metal is cleaned
		Phosphating, based on iron salts
		Drying in a tunnel at 100°C
		External and internal coating with electrostatic application of thermosetting powder coating with epoxy-polyester binders, RAL 7035 colour orange peel finish, total thickness 60/70 microns.
Coating characteristics		Curing in an oven 180°C
	Binder:	epoxy-polyester
	Specific gravity:	1.61g/cm ³
	Theoretic yield:	10.4m ² /kg with film an average 60 microns thick
	Melting point:	85-95 °C (Kofler bench method)
	Particle size:	standard distribution between 5 and 100 microns with 30 to 40 micron average particle size. Setting: 12 min x 190 °C (temperature of object).
	Hardness:	1H - 2H
	DIN 53152 bending elasticity:	unaltered on 1/4" mandrel
	DIN 53151 cross-hatch adhesion:	GT 0 (100%)
	Erichem elasticity:	SEN DIN 53156: > 6mm
Gardner impact resistance:	25 kg x cm.	
Tests performed on degreased and phosphatized metal plates with 60/70 micron film thickness. The paint coating passed the saline mist resistance tests (193 hours).		
Environmental characteristics		
Type of installation		indoor
Installation conditions		on floor
Climatic conditions (t°/Rh%)	constant	23°C/83% - 40°C/93%
	variable	23°C/98% - 40°C/98%
Ambient temperature limits	for operation	-5°C +40°C Normal usage conditions (Ref. sect. 7.1 of the Standard IEC 61439-1-2)
	for storage	-25°C +55°C

System pro E power

Technical details and certifications

ABB SACE Declaration of conformity

System pro E power switchboards with rated characteristics:

Rated service voltage Ue	up to 1000V AC / 1500V DC
Rated insulation voltage Ui	up to 1000V AC / 1500V DC
Rated current / Icw	up to 6300A / fino a 120kA
IP protection class	IP30, IP31, IP40, IP41, IP65

If the components have been chosen and assembled correctly, as described in the catalogue and instruction manual, the resulting switchboards will conform to Standard IEC 61439-1-2, in accordance with the provisions established by the Low Voltage Directive adopted by the European Union 2007/95/EC (formerly Directive 73/23/EEC, Law 791/1977).

The above is valid if the switchboard has been designed and built:

- having chosen the materials on the basis of the performance values indicated in the ABB catalogues;
- having sized the conductors in accordance with the provisions established by Standards EN 61439-1 and CEI 64-8;
- having performed the individual tests established by Standard IEC 61439-1-2 and obtained positive results.

Technical details

Information about disposal at the end of the lifecycle of the products







ABB SACE has conducted research into the end of the lifecycle of the product. The assessments were made by applying the LCA (Life Cycle Assessment) method as established by ISO 14040 - 1997 and in accordance with the requirements established by SEMC in the ISO TR 14025 TYPE III Environmental declarations (MSR 1999:2 – “Guidelines Environmental Product Declarations”) document.

The research was conducted considering the disposal and recycling processes of the main materials forming a typical switchboard.

Using the bill of materials as a starting point, the researchers considered the ease with which each part can be disassembled and separated as well as the ability to recycle the materials. They found that the product is almost entirely recyclable.

After this, they limited the bill of materials to the most significant components and assessed the lifecycle of each.

The result was the flow of recyclable materials and salvaged materials (or for incineration) indicated in the Table. In theory, none of the materials should end up in a landfill.

Substance	Destination	
Aluminium scrap	Recycling	
Copper scrap	Recycling	
Polyurethane gaskets	Incineration	
Fiberglass	Recycling	
Scrapped glass	Recycling	
Paper/cardboard	Recycling	
Plastic insulators	Recycling	
Sheet metal scrap	Recycling	

Power dissipated

System pro E power IP31

		Separate enclosure exposed on all sides				Separate enclosure for assembly on a wall				First and last enclosures exposed				First and last enclosures for assembly on wall				Central enclosure exposed				Central enclosure for assembly on a wall			
		Maximum power dissipated (W)				Maximum power dissipated (W)				Maximum power dissipated (W)				Maximum power dissipated (W)				Maximum power dissipated (W)				Maximum power dissipated (W)			
W (mm)	D (mm)	25 °C	30 °C	35 °C	40 °C	25 °C	30 °C	35 °C	40 °C	25 °C	30 °C	35 °C	40 °C	25 °C	30 °C	35 °C	40 °C	25 °C	30 °C	35 °C	40 °C	25 °C	30 °C	35 °C	40 °C
Structures H = 1800mm with blind panels																									
400	200	223	280	338	400	208	258	314	371	208	262	315	374	187	234	281	332	193	246	296	350	170	215	260	310
400	300	257	322	389	460	242	301	366	433	237	298	359	425	216	270	324	383	217	276	332	393	194	245	297	353
400	500	290	364	440	520	276	344	418	494	265	333	402	476	244	305	367	434	240	305	367	435	218	274	333	395
400	700	371	461	560	668	349	440	535	622	329	410	495	588	300	377	457	539	297	370	455	536	273	343	415	491
400	900	445	553	672	802	419	528	642	746	395	492	594	706	360	452	548	647	356	444	546	643	328	412	498	589
600	200	285	357	433	511	259	324	393	464	268	336	407	481	237	297	359	424	255	320	387	457	223	279	338	400
600	300	328	412	499	589	302	378	458	541	306	383	464	549	273	342	414	489	286	359	434	513	254	319	386	456
600	500	371	466	564	666	344	432	523	617	343	430	521	616	309	387	469	553	316	397	481	568	285	358	434	512
600	700	428	537	651	769	426	535	648	765	407	511	619	731	388	486	589	695	384	481	583	688	352	442	535	632
600	900	514	644	781	923	511	642	778	918	488	613	743	877	466	583	707	834	461	577	700	826	422	530	642	758
800	200	356	446	540	638	319	400	484	572	339	425	515	608	296	371	449	530	327	410	496	586	283	355	430	508
800	300	390	489	592	699	367	461	558	659	374	469	568	671	339	425	514	607	365	458	554	654	321	403	488	577
800	500	423	531	643	759	415	521	631	745	408	512	621	733	381	478	579	684	402	505	611	722	359	451	546	645
800	700	489	614	743	877	478	599	726	857	463	581	703	830	450	564	683	807	454	570	690	815	434	544	659	778
800	900	587	737	892	1052	574	719	871	1028	556	697	844	996	540	677	820	968	545	684	828	978	521	653	791	934
1000	900	683	824	961	1098	670	812	968	1123	651	793	945	1102	632	776	927	1086	638	780	930	1089	612	757	913	1070
1250	900	799	964	1124	1285	784	950	1133	1314	762	928	1106	1289	739	908	1085	1271	746	913	1088	1274	716	886	1068	1252
Structures H = 2000mm with blind panels																									
400	200	242	304	368	435	224	268	337	399	223	280	339	399	200	251	304	359	209	260	316	377	183	230	278	329
400	300	277	349	422	498	261	314	393	465	254	318	385	454	203	289	350	413	234	291	354	422	208	262	316	374
400	500	312	393	476	561	297	360	448	530	284	356	431	508	260	327	395	467	258	322	392	466	233	293	354	419
400	700	393	495	598	705	378	475	577	680	356	444	538	636	306	386	469	550	319	397	480	565	291	365	442	525
400	900	472	594	718	846	454	570	692	816	427	533	646	763	367	463	563	660	383	476	576	678	349	438	530	630
600	200	304	382	463	546	277	347	420	496	287	360	436	514	253	317	384	454	273	342	415	489	237	298	360	426
600	300	343	431	522	616	324	406	491	580	327	410	497	586	292	384	444	524	307	384	466	549	271	340	411	486
600	500	382	479	581	685	370	464	562	663	367	460	557	658	331	451	503	594	340	426	516	609	304	381	462	545
600	700	441	554	671	792	435	546	662	781	416	522	632	746	408	512	620	732	406	509	617	728	373	468	566	669
600	900	529	665	805	950	522	655	794	937	499	626	758	895	490	614	744	878	487	611	740	874	448	562	679	803
800	200	368	462	559	660	340	427	517	610	362	454	550	650	315	395	479	565	349	437	530	625	301	378	458	541
800	300	402	504	611	721	381	479	580	684	390	489	592	700	359	450	546	644	381	433	579	684	341	428	518	612
800	500	436	546	662	781	422	530	642	758	417	524	634	749	402	505	612	722	413	519	628	742	380	477	578	682
800	700	512	643	778	919	494	620	751	887	480	602	729	861	461	578	701	827	466	585	709	837	451	566	685	809
800	900	614	772	934	1103	593	744	901	1064	576	722	875	1033	553	694	841	992	559	702	851	1004	541	679	822	971
1000	900	721	864	1022	1198	700	858	1023	1184	681	833	987	1145	659	799	947	1100	670	814	967	1123	653	792	938	1092
1250	900	844	1011	1196	1402	819	1004	1197	1385	797	975	1155	1340	771	935	1108	1287	784	952	1131	1314	764	927	1097	1278

Power dissipated inside System pro E power switchboards on the basis of the admissible overtemperature.

Δt = difference between the temperature inside the enclosure and ambient temperature.

Example

Enclosure IP31 H=1800mm, W=400mm, D=200mm esposed on all sides

Temperature inside the enclosure (t)	°C	70 –
Ambient temperature (t)	°C	35 =
Δt	°C	35

Maximum power dissipated	(W)	338
---------------------------------	------------	------------

System pro E power

Technical details and certifications

Power dissipated

System pro E power IP30/31

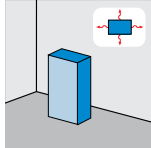
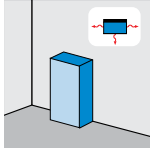
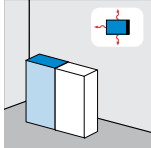
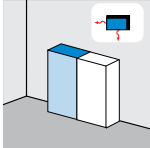
		Separate enclosure exposed on all sides				Separate enclosure for assembly on a wall (values obtained with blind rear panels)				First and last enclosures exposed				First and last enclosures for assembly on a wall (values obtained with blind rear panels)			
																	
		Maximum power dissipated (W)				Maximum power dissipated (W)				Maximum power dissipated (W)				Maximum power dissipated (W)			
W (mm)	D (mm)	25 °C	30 °C	35 °C	40 °C	25 °C	30 °C	35 °C	40 °C	25 °C	30 °C	35 °C	40 °C	25 °C	30 °C	35 °C	40 °C
Structures H = 1800mm with ventilated panels																	
600	500	571	737	914	1102	541	698	866	1044	428	552	685	826	406	524	650	784
600	700	737	951	1180	1422	712	919	1140	1374	552	713	884	1066	518	668	829	999
800	500	649	837	1038	1252	611	788	978	1179	502	648	804	969	460	593	736	887
800	700	836	1079	1339	1613	787	1016	1261	1519	625	806	1000	1205	595	768	953	1149
1000	900	1295	1606	1926	2235	1147	1444	1750	2074	914	1146	1401	1666	818	1035	1266	1516
1250	900	1450	1799	2157	2503	1273	1603	1943	2302	1024	1284	1569	1866	908	1149	1405	1683
Structures H = 2000mm with ventilated panels																	
600	500	586	756	938	1131	546	705	874	1131	434	560	695	838	407	525	651	785
600	700	741	956	1186	1429	715	923	1145	1380	560	723	897	1081	527	680	843	1016
800	500	654	844	1047	1261	623	804	997	1202	507	654	811	978	468	604	749	903
800	700	861	1112	1379	1662	792	1022	1268	1528	640	826	1024	1234	596	769	955	1151
1000	900	1333	1655	1983	2301	1154	1452	1759	2086	935	1176	1434	1706	820	1036	1263	1520
1250	900	1493	1854	2221	2577	1281	1612	1952	2315	1047	1317	1606	1911	910	1150	1402	1687

Power dissipated inside System pro E power switchboards on the basis of the admissible overtemperature.

Δt = difference between the temperature inside the enclosure and ambient temperature.

Power dissipated

System pro E power IP40/41

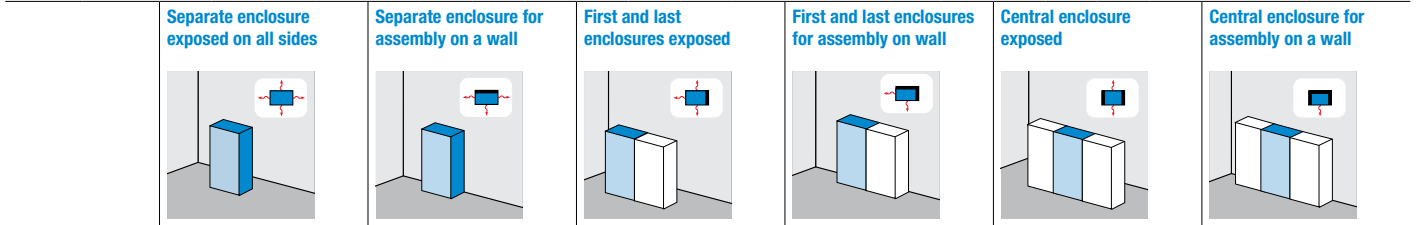

W (mm)	D (mm)	Maximum power dissipated (W)				Maximum power dissipated (W)				Maximum power dissipated (W)				Maximum power dissipated (W)				Maximum power dissipated (W)			
		25 °C	30 °C	35 °C	40 °C	25 °C	30 °C	35 °C	40 °C	25 °C	30 °C	35 °C	40 °C	25 °C	30 °C	35 °C	40 °C	25 °C	30 °C	35 °C	40 °C

Structures H = 1800mm with blind panels

400	200	223	280	338	400	208	258	314	371	208	262	315	374	187	234	281	332	193	246	296	350	170	215	260	310
400	300	257	322	389	460	242	301	366	433	237	298	359	425	216	270	324	383	217	276	332	393	194	245	297	353
400	500	290	364	440	520	398	514	637	768	265	333	402	476	304	392	486	586	240	305	367	435	218	274	333	395
400	700	371	461	560	668	544	703	872	1051	329	410	495	588	382	493	612	738	297	370	455	536	273	343	415	491
400	900	445	553	672	802	725	937	1163	1401	395	492	594	706	449	580	720	868	356	444	546	643	328	412	498	589
600	200	285	357	433	511	259	324	393	464	268	336	407	481	237	297	359	424	255	320	387	457	223	279	338	400
600	300	328	412	499	589	302	378	458	541	306	383	464	549	273	342	414	489	286	359	434	513	254	319	386	456
600	500	371	466	564	666	462	596	739	891	343	430	521	616	350	451	560	674	316	397	481	568	285	358	434	512
600	700	428	537	651	769	627	809	1004	1210	407	511	619	731	438	565	701	845	384	481	583	688	352	442	535	632
600	900	514	644	781	923	836	1079	1339	1613	488	613	743	877	515	665	825	994	461	577	700	826	422	530	642	758
800	200	356	446	540	638	319	400	484	572	339	425	515	608	296	371	449	530	327	410	496	586	283	355	430	508
800	300	390	489	592	699	367	461	558	659	374	469	568	671	339	425	514	607	365	458	554	654	321	403	488	577
800	500	423	531	643	759	525	678	841	1013	408	512	621	733	405	523	648	781	402	505	611	722	359	451	546	645
800	700	489	614	743	877	689	889	1103	1329	463	581	703	830	473	661	819	988	454	570	690	815	434	544	659	778
800	900	587	737	892	1052	919	1185	1471	1772	556	697	844	996	556	778	964	1162	545	684	828	978	521	653	791	934
1000	900	683	824	961	1098	1072	1338	1634	1935	651	793	945	1102	650	891	1089	1303	638	780	930	1089	612	757	913	1070
1250	900	799	964	1124	1285	1190	1485	1814	2148	762	928	1106	1289	722	989	1209	1446	746	913	1088	1274	716	886	1068	1252

Structures H = 2000mm with blind panels

400	200	242	304	368	435	224	268	337	399	223	280	339	399	200	251	304	359	209	260	316	377	183	230	278	329
400	300	277	349	422	498	261	314	393	465	254	318	385	454	203	289	350	413	234	291	354	422	208	262	316	374
400	500	312	393	476	561	403	519	644	777	284	356	431	508	309	398	492	591	258	322	392	466	233	293	354	419
400	700	393	495	598	705	547	706	876	1056	356	444	538	636	389	498	617	743	319	397	480	565	291	365	442	525
400	900	472	594	718	846	729	941	1168	1408	427	533	646	763	458	586	726	874	383	476	576	678	349	438	530	630
600	200	304	382	463	546	277	347	420	496	287	360	436	514	253	317	384	454	273	342	415	489	237	298	360	426
600	300	343	431	522	616	324	406	491	580	327	410	497	586	292	384	444	524	307	384	466	549	271	340	411	486
600	500	382	479	581	685	466	602	747	900	367	460	557	658	353	456	565	681	340	426	516	609	304	381	462	545
600	700	441	554	671	792	632	815	1011	1219	416	522	632	746	448	578	717	864	406	509	617	728	373	468	566	669
600	900	529	665	805	950	843	1087	1348	1625	499	626	758	895	527	680	844	1016	487	611	740	874	448	562	679	803
800	200	368	462	559	660	340	427	517	610	362	454	550	650	315	395	479	565	349	437	530	625	301	378	458	541
800	300	402	504	611	721	381	479	580	684	390	489	592	700	359	450	546	644	381	433	579	684	341	428	518	612
800	500	436	546	662	781	536	692	859	1035	417	524	634	749	410	528	656	790	413	519	628	742	380	477	578	682
800	700	512	643	778	919	701	905	1123	1353	480	602	729	861	510	658	816	983	466	585	709	837	451	566	685	809
800	900	614	772	934	1103	935	1207	1497	1804	576	722	875	1033	600	774	960	1156	559	702	851	1004	541	679	822	971
1000	900	721	864	1022	1198	1103	1391	1699	1998	681	833	987	1145	714	891	1080	1281	670	814	967	1123	653	792	938	1092
1250	900	844	1011	1196	1402	1224	1544	1886	2218	797	975	1155	1340	793	989	1199	1422	784	952	1131	1314	764	927	1097	1278

Power dissipated inside System pro E power switchboards on the basis of the admissible overtemperature.

Δt = difference between the temperature inside the enclosure and ambient temperature.

System pro E power

Technical details and certifications

Power dissipated

System pro E power IP40/41

		Separate enclosure exposed on all sides				Separate enclosure for assembly on a wall (values obtained with blind rear panels)				First and last enclosures exposed				First and last enclosures for assembly on a wall (values obtained with blind rear panels)			
		Maximum power dissipated (W)				Maximum power dissipated (W)				Maximum power dissipated (W)				Maximum power dissipated (W)			
W (mm)	D (mm)	25 °C	30 °C	35 °C	40 °C	25 °C	30 °C	35 °C	40 °C	25 °C	30 °C	35 °C	40 °C	25 °C	30 °C	35 °C	40 °C
Structures H = 1800mm with ventilated panels																	
400	500	418	539	669	806	398	514	637	768	317	409	507	611	304	392	486	586
400	700	562	725	899	1084	544	703	872	1051	395	509	632	761	382	493	612	738
400	900	749	967	1199	1445	725	937	1163	1401	494	636	790	951	449	580	720	868
600	500	489	631	783	944	462	596	739	891	376	485	602	725	350	451	560	674
600	700	651	840	1042	1256	627	809	1004	1210	471	608	754	909	438	565	701	845
600	900	868	1120	1389	1675	836	1079	1339	1613	589	760	943	1136	515	665	825	994
800	500	560	723	897	1081	525	678	841	1013	438	565	700	844	405	523	648	781
800	700	733	946	1174	1415	689	889	1103	1329	524	676	838	1010	473	661	819	988
800	900	977	1261	1565	1887	919	1185	1471	1772	655	845	1048	1263	556	778	964	1162
1000	900	1135	1408	1688	1962	1072	1338	1634	1935	766	960	1173	1397	650	891	1089	1303
1250	900	1271	1577	1891	2197	1190	1485	1814	2148	858	1075	1314	1565	722	989	1209	1446
Structures H = 2000mm with ventilated panels																	
400	500	422	543	671	809	403	519	644	777	320	413	511	615	309	398	492	591
400	700	567	732	908	1094	547	706	876	1056	398	514	635	765	389	498	617	743
400	900	756	976	1211	1459	729	941	1168	1408	498	643	794	956	458	586	726	874
600	500	503	649	805	970	466	602	747	900	379	489	607	732	353	456	565	681
600	700	657	847	1051	1267	632	815	1011	1219	477	616	764	921	448	578	717	864
600	900	876	1129	1401	1689	843	1087	1348	1625	596	770	955	1151	527	680	844	1016
800	500	566	731	907	1093	536	692	859	1035	440	568	705	850	410	528	656	790
800	700	764	985	1222	1474	701	905	1123	1353	546	705	874	1054	510	658	816	983
800	900	1019	1313	1629	1965	935	1207	1497	1804	683	881	1093	1318	600	774	960	1156
1000	900	1196	1497	1782	2134	1103	1391	1699	1998	807	1016	1232	1460	714	891	1080	1281
1250	900	1340	1677	1996	2390	1224	1544	1886	2218	904	1138	1380	1635	793	989	1199	1422

Power dissipated inside System pro E power switchboards on the basis of the admissible overtemperature.

Δt = difference between the temperature inside the enclosure and ambient temperature.

Power dissipated

System pro E power IP65

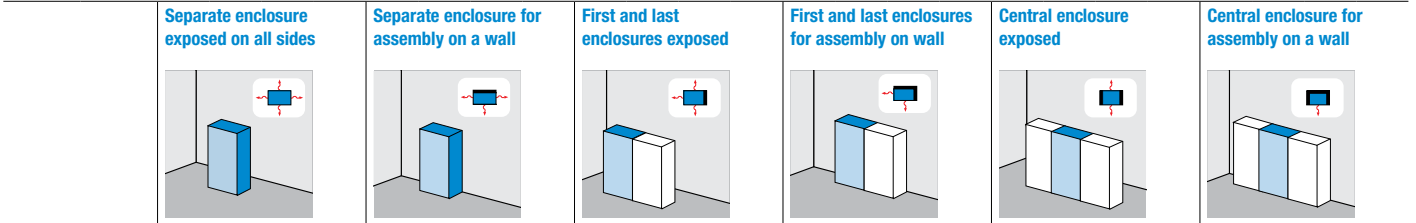

W (mm)	D (mm)	Maximum power dissipated (W)				Maximum power dissipated (W)				Maximum power dissipated (W)				Maximum power dissipated (W)				Maximum power dissipated (W)				Maximum power dissipated (W)			
		25 °C	30 °C	35 °C	40 °C	25 °C	30 °C	35 °C	40 °C	25 °C	30 °C	35 °C	40 °C	25 °C	30 °C	35 °C	40 °C	25 °C	30 °C	35 °C	40 °C	25 °C	30 °C	35 °C	40 °C

Structures H = 1800mm with blind panels

400	300	223	284	344	406	213	267	323	381	206	258	313	370	188	236	286	338	188	236	286	338	170	213	258	305
400	200	193	242	293	346	179	224	271	320	178	223	270	319	160	201	243	287	165	207	251	296	146	184	222	263
400	500	260	326	395	466	247	310	375	443	235	294	357	421	217	272	329	389	212	266	322	381	194	243	295	348
400	700	328	411	498	588	317	398	482	569	290	364	440	520	274	344	417	492	259	325	394	465	243	304	369	435
400	900	386	484	586	692	373	468	567	669	341	428	518	612	322	405	491	579	305	382	464	547	286	358	434	512
600	300	292	366	443	524	268	336	407	481	271	341	413	488	242	304	368	435	279	319	386	456	226	284	343	406
600	200	254	318	385	455	230	289	350	413	238	299	362	428	210	264	320	378	227	285	345	407	198	249	301	356
600	500	331	415	502	593	306	384	465	549	305	383	464	548	275	344	417	493	282	353	428	505	254	319	386	456
600	700	381	478	579	684	379	476	577	681	362	455	551	650	345	433	524	619	341	428	519	612	314	393	477	563
600	900	448	562	681	805	446	560	679	801	426	535	648	765	406	509	616	728	401	504	611	720	369	462	561	662
800	300	346	435	526	622	326	409	496	586	332	417	505	596	301	378	458	540	324	407	493	581	286	358	434	513
800	200	316	397	481	568	284	356	431	509	302	378	458	541	263	330	400	472	291	365	442	521	252	316	383	452
800	500	377	473	572	676	369	463	561	663	363	456	552	652	339	426	516	609	358	449	544	642	320	401	486	574
800	700	435	546	661	781	425	533	646	763	412	517	626	739	400	502	608	718	404	507	614	725	386	484	586	692
800	900	512	642	778	919	500	627	760	898	485	608	736	869	471	591	715	845	475	596	722	853	454	569	689	814
1000	900	596	718	838	959	583	708	844	981	568	692	832	975	551	677	808	948	556	679	811	950	533	659	795	932
1250*	900	697	840	980	1122	682	828	987	1148	665	810	973	1141	645	792	945	1109	651	794	949	1112	624	771	930	1090

Structures H = 2000mm with blind panels

400	300	244	306	371	438	228	287	347	410	221	278	337	397	202	254	307	363	202	254	308	363	182	228	277	327
400	200	209	262	317	375	192	241	292	345	191	240	291	343	172	216	262	309	178	223	270	319	157	197	239	282
400	500	279	351	425	501	265	333	403	476	252	316	383	452	232	292	353	417	227	285	346	408	207	260	315	372
400	700	354	444	537	634	341	428	519	612	314	394	478	564	295	370	448	529	278	349	423	499	258	324	393	464
400	900	416	522	632	746	401	504	611	720	369	464	562	664	347	435	527	622	327	411	498	587	304	381	462	546
600	300	305	383	464	548	287	361	437	516	290	364	442	521	260	342	395	466	272	342	414	459	241	302	366	432
600	200	271	340	412	486	246	309	374	442	255	320	388	458	225	282	342	404	243	305	369	436	211	265	321	379
600	500	340	426	517	610	329	413	500	590	326	409	496	585	295	402	448	528	302	379	459	542	271	339	411	485
600	700	393	493	597	705	387	486	589	695	370	464	562	664	363	455	552	651	361	453	549	648	332	416	504	595
600	900	462	580	702	829	455	572	693	818	435	546	661	781	427	535	649	766	425	533	646	762	391	489	593	700
800	300	358	448	543	641	339	404	515	609	346	406	527	622	319	400	485	573	339	425	515	608	303	380	461	544
800	200	328	411	498	588	303	380	460	543	322	404	490	578	280	352	426	503	310	389	471	557	268	337	408	481
800	500	388	486	589	695	376	472	571	675	371	466	565	667	358	449	544	643	368	462	559	660	338	424	514	607
800	700	456	572	693	818	440	552	668	789	427	536	649	766	410	515	624	736	415	521	631	745	401	503	610	720
800	900	536	673	815	962	518	649	786	928	502	631	764	901	482	606	734	866	488	613	742	876	472	592	718	847
1000	900	629	753	892	1045	611	748	892	1092	593	728	862	998	574	697	826	960	585	710	843	980	569	690	819	952
1250	900	736	881	1044	1223	715	875	1044	1278	694	852	1009	1168	672	815	966	1123	684	831	986	1147	666	807	958	1114

Power dissipated inside System pro E power switchboards on the basis of the admissible overtemperature.

Δt = difference between the temperature inside the enclosure and ambient temperature.

System pro E power

Technical details and certifications

Handling

Handling with a transpallet

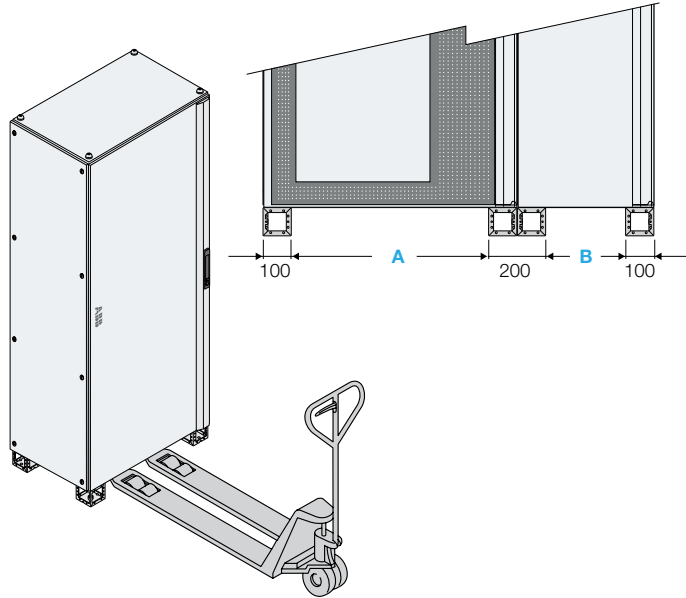

7

Shallow switchboards should be handled in the following way:

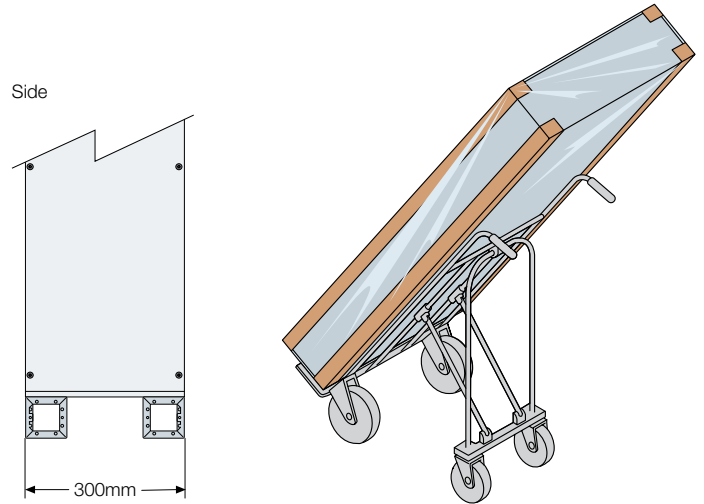

Check the center of gravity before handling structures measuring L=800/1000mm (with internal or external cable compartment) containing busbar systems.

Dimensions	A (mm)
Larghezza 300mm	198
Larghezza 400mm	298
Larghezza 600mm	498
Larghezza 800mm	698
Larghezza 1000mm	898
Larghezza 1250mm	1098

For extra safety, it is advisable to fasten the switchboard to the lift truck when using this type of vehicle for transport.

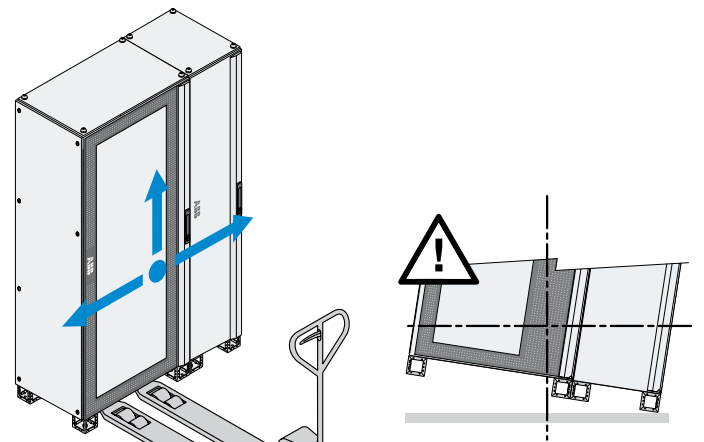
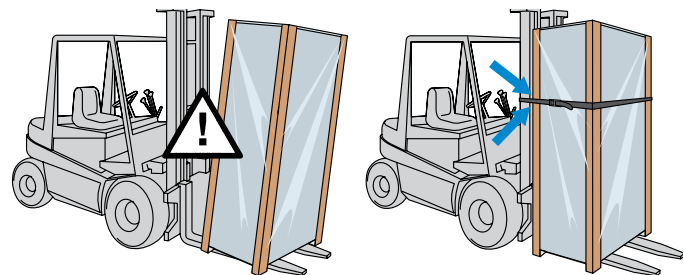

Handling with a bridge crane

Before handling switchboards with a crane or bridge crane, make sure that:

- the ropes or chains are in an excellent condition;
- the angle between the lifting ropes and the top of the switchboard must be $\geq 45^\circ$;
- up to 3 units can be carried at the same time;
- maximum weight lifted as established by Standard DIN 580 (M12).

To comply with the conditions described above, use a lifting beam with the appropriate characteristics when lifting several adjacent units.

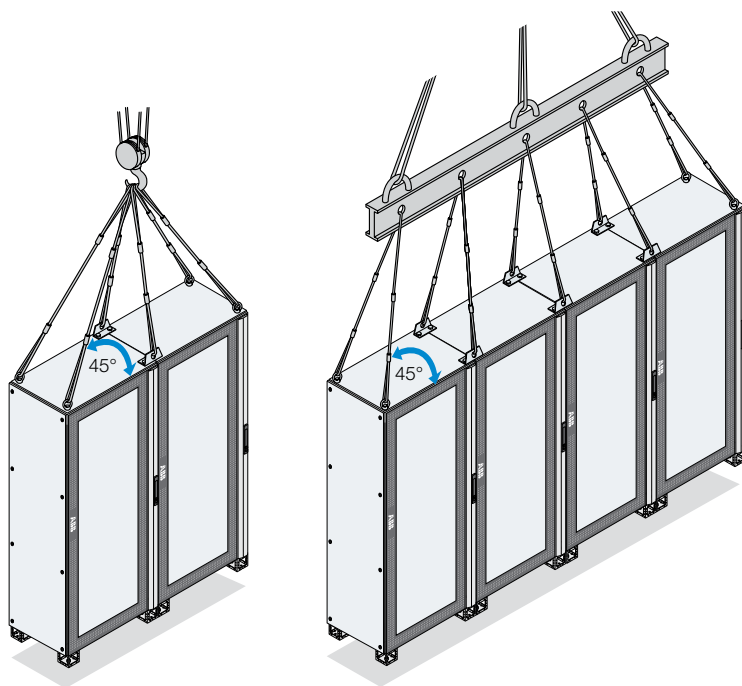

Standard DIN 580 concerning mechanical connection components (only for eyebolts)

Eyebolts		Lifting reinforcements								
A	B (mm)	C (mm)	D (mm)	E (mm)	F (mm)	G (mm)	Load 1 (kg)	Load 2 (kg)	Tightening (Nm)	
Eyebolts										
M12	54	12	28	10	22	30	340	240	8*	
Lifting reinforcements										
M12	Ø40	37	80	25	Ø14	60	510	350	40	

* Tighten by hand without mechanical aids because this can cause damages by reducing the scope of the eyebolt.

System pro E power

Electrical continuity of the structure and fixed and movable parts

The accessible metal parts in a switchboard must be electrically connected together and with the main protection conductor. Ω 0.1 is the maximum resistance value allowed for this circuit.

Electrical continuity in System pro E power switchboards is automatically guaranteed by the screws and bolts and by the way the structure assembly is engineered. In addition, the connections can be made using the earthing pins on the external covers.

The panels are earthed by means of the fastening screw, as required by standard IEC 61439-1 (part 8.4.3.2.2) "Specifications for earthing continuity to protect against the consequences of faults within switchgear": "b) For covers, doors, closing plates and similar, the ordinary connections with metal screws and metal hinges are considered sufficient for electrical continuity so long as electrical devices that exceed the low voltage limits (ELV) are not installed on them". To achieve this:

- only and exclusively use the screws and accessories supplied with the components
- comply with the assembly instructions given in the manuals

The proposed solutions have been tested and no additional earthing braid is required.

The paint reduces the electrical continuity of the assembled parts. To assure electrical continuity, use screws with toothed washers that cut into the paint or, alternatively, earthing braid. To assure electrical continuity, the mechanical assemblies (front

plates, bottom plates, etc.) are also made with devices that cut into the painted surface:

- clips
- 1/4-turn screws
- self-threading screws
- screws + nuts with sharp-toothed washers

It is obligatory to use a braid for the earth connection in the case of movable metal parts (doors, swing frames or removable panels) that must support electrical components differing from class 2 (which, being fitted with double insulation, are not earthed).

Electrical continuity in the case of front panels, is guaranteed in the closed position by the special shape of the hinge (ABB patent), always supplied even in the absence of connection via conductor.

Earthing braid is supplied on request for the electrical components installed on the door, as well as for the passage of cables from communicating or low power circuits: analog, digital and telecommunication cables.

Since the internal parts and the circuit-breaker assembly kits are made of unpainted galvanized steel, continuity is guaranteed without any additional earthing braid.

The earth conductor must be properly sized in relation to the maximum operating current, as shown in the following table defined by Standard IEC 61439-1.

Calculation of protection conductor PE

Standard IEC 61439-1-2 contain the methods for calculating the section of the protection conductor PE, which must be sized to withstand the thermal and dynamic components of the fault currents.

The following conditions must be ascertained when choosing the position in which the bar is to be fixed:

- the bar must be connected straight to the earthed parts of the switchboard (structure);
- the bar must be connected in an easily accessible position.

Use the values in the table for sizing taken from Standards IEC 61439-1-2.

S (mm ²)				Sp (mm ²)	
		S	≤	16	S
16	<	S	≤	35	16
35	<	S	≤	400	S/2
400	<	S	≤	800	200
		S	>	800	S/4

System pro E power

Technical details and certifications

Equipotentiality

Conductive parts of a device, which cannot be connected to the protection circuit with their own means of connection, must be connected to the protection circuit of the apparatus through the equipotentiality of the protection. This is done by means of a protective bonding conductor, the section of which must be chosen in accordance with the table below.

Rated service voltage I_e (A)				Minimum section of the protective bonding conductor (mm ²)	
		I_e	≤	20	S
20	<	I_e	≤	25	2,5
25	<	I_e	≤	32	4
32	<	I_e	≤	63	6
63	<	I_e			10

S = section of the line conductor (mm²)

Conductor PEN

The section of the PEN conductors of an apparatus must be determined in the same way as the neutral conductor (N).

10mm² is the minimum section of a copper conductor.

The PEN conductor does not need to be insulated.

Structure parts must not be used as a PEN conductors. However, the copper or aluminium assembly tracks can be used as PEN conductors.

For conductors that are not made of copper, equivalent conductivity sections are used instead of the sections above and may require larger terminals.

Mechanical shock resistance IK

The IK is expressed in Joule in compliance with the requirements of IEC 62262.

IK 0

Not protected



IK 06

Impact energy in Joule **1.00**

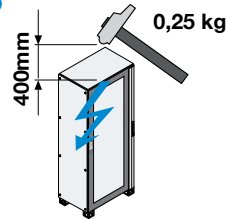

IK 01

Impact energy in Joule **0.140**

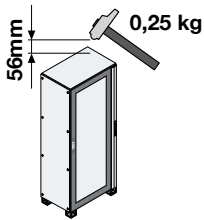

IK 07

Impact energy in Joule **2.00**

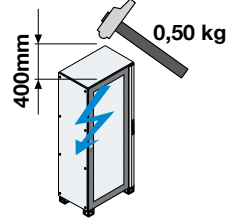

IK 02

Impact energy in Joule **0.200**

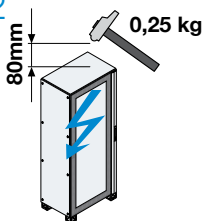

IK 08

Impact energy in Joule **5.00**

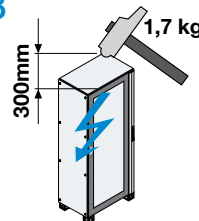

IK 03

Impact energy in Joule **0.350**

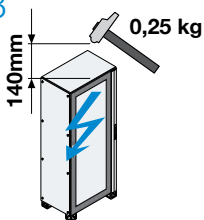

IK 09

System pro E power
Glass door

Impact energy in Joule **10.00**

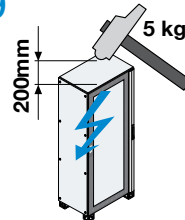

IK 04

Impact energy in Joule **0.500**

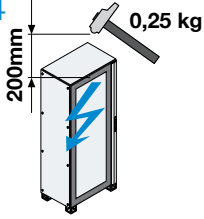

IK 10

System pro E power
Blind door

Impact energy in Joule **20.00**

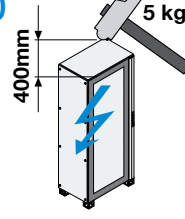

IK 05

Impact energy in Joule **0.700**

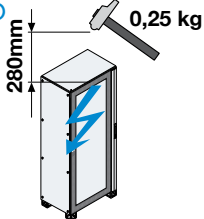

System pro E power

Technical details and certifications

IP protection class

1st DIGIT: protection against solid objects

0 No protection

1  Protected against solid objects larger than 50mm (accidental contact with the hands)

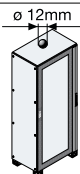
2  Protected against solid objects larger than 12mm (fingers)

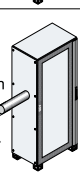
7 3  Protected against solid objects larger than 2.5mm (tools, wires)

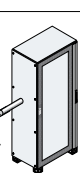
4  Protected against solid objects larger than 1mm

5  Protected against dust (no harmful deposits)

6  Totally protected against dust

1st digit defined by Standards 61439-1-2 (Ref. sect. 10.3).

2nd DIGIT: Protection against liquids

0 No protection

1  Protected against vertically dripping water (condensation)

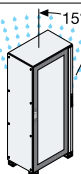
2  Protected against water dripping at an angle up to 15° from the vertical

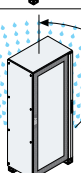
3  Protected against rain falling at an angle up to 60° from the vertical

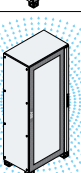
4  Protected against water splashing from all directions

5  Protected against jets of water sprayed from all directions

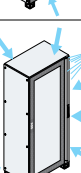
6  Protected against jets of water similar to waves

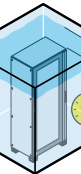
7  Protected against the effects of temporary immersion

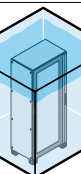
8  Protected against the effects of continuous immersion

2nd digit defined by Standards 61439-1-2 (Ref. sect. 10.3).

IP protection class

Protection against ingress of solid objects

1 st characteristic digit	Brief description	Full description
0	Not protected	No particular protection is envisaged
1	Protected against solid objects larger than 50mm	A large area of the human body, for example a hand (however, voluntary protection is not envisaged) or solid objects larger than 50mm in diameter must not be able to penetrate
2	Protected against solid objects measuring	The fingers or similar objects measuring 80mm or solid objects more than 12mm in diameter must not be able to penetrate
3	Protected against solid objects measuring more than 2.5mm	Tools, wires, etc., more than 2.5mm in diameter or thickness or solid objects more than 2.5mm in diameter must not be able to penetrate
4	Protected against solid objects measuring more than 1.0mm	Wires or flat cables more than 1.0mm thick or solid objects more than 1.0mm in diameter must not be able to penetrate
5	Protected against dust	Penetration of dust is not totally excluded but the quantity that may penetrate is not sufficient to impair the correct operation of the material
6	Totally protected against dust	No dust penetration is permitted

Protection against ingress of water

2 nd characteristic digit	Brief description	Full description
0	Not protected	No particular protection is envisaged
1	Protected against dripping water	Drops of water falling vertically must not produce harmful effects
2	Protected against water dripping at a maximum angle of 15°	Drops of water falling vertically must not produce harmful effects when the enclosure is tilted at any angle up to 15° from its normal position
3	Protected against rainfall	Water falling as a spray at any angle up to 60° from the vertical shall have no harmful effects
4	Protected against splashing water	Water splashing against the enclosure from any direction shall have no harmful effects
5	Protected against water jets	Water projected by a nozzle from any direction shall have no harmful effects
6	Protected against waves	Waves or powerful water jets shall not penetrate the enclosure in harmful quantities
7	Protected against the effects of temporary immersion	Ingress of water in harmful quantities shall not be possible when the enclosure is immersed in water under defined conditions of pressure and time
8	Protected against the effects of continuous immersion	The equipment is suitable for continuous immersion under conditions which shall be specified by the manufacturer

System pro E power

Technical details and certifications

Connection examples - Unifix H

Unifix H frame with 400A busbars 24 and 36 DIN modules

Busbars supplied from above by means of a 4P feeder module installed laterally

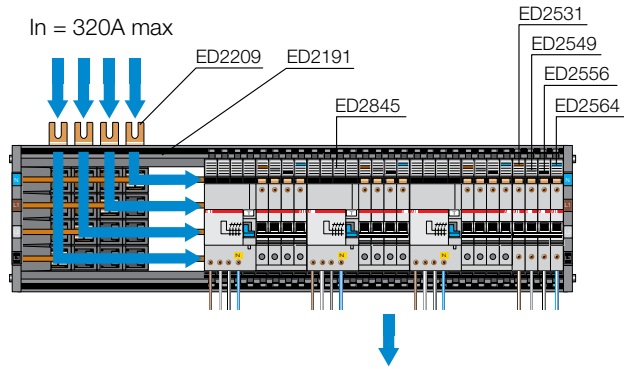

Power supply by means of circuit-breaker supplied from above

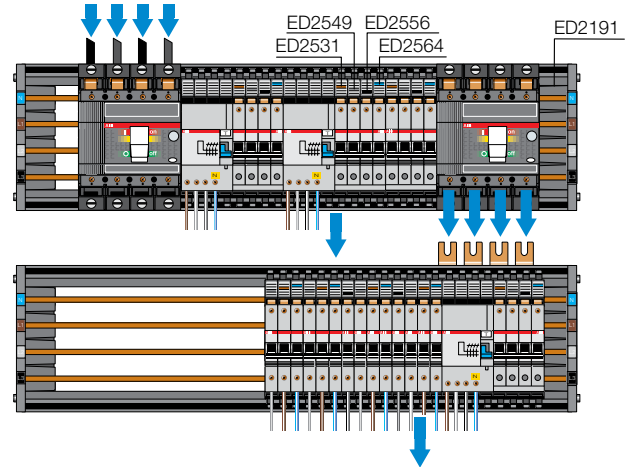

7

Busbars supplied from below by means of a 4P feeder module installed laterally

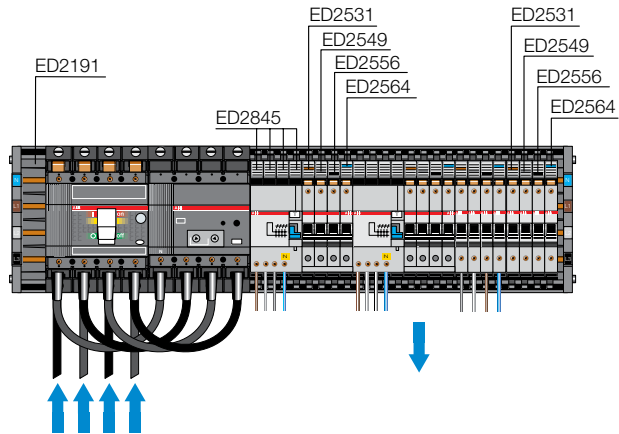

Power supply by means of circuit-breaker supplied from below

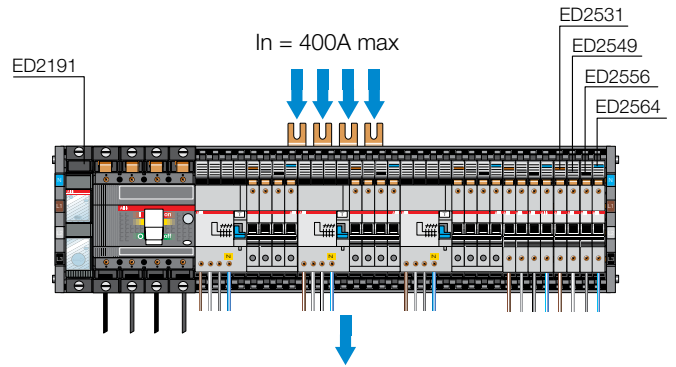

Busbars supplied from above by means of a 4P feeder module installed centrally

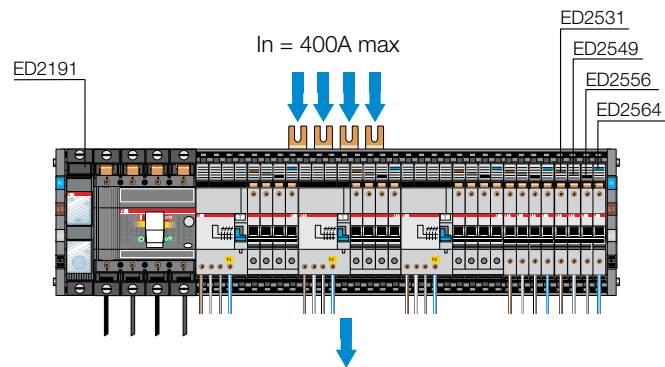

Covers for IP 20 protection class

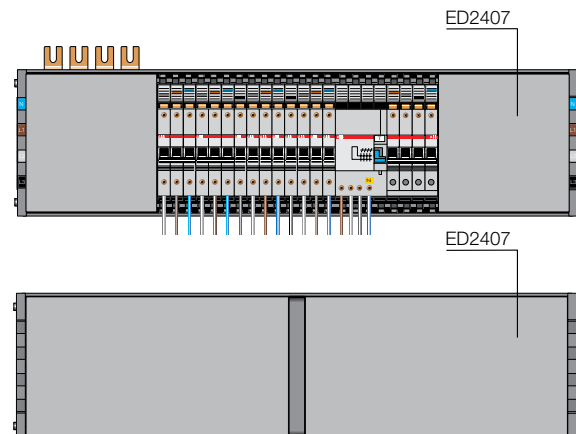

Connection examples - Unifix L

Unifix L frame with 100A busbars 12/18/24 DIN modules

Two different single-phase circuits on a single DIN rail with 24 modules

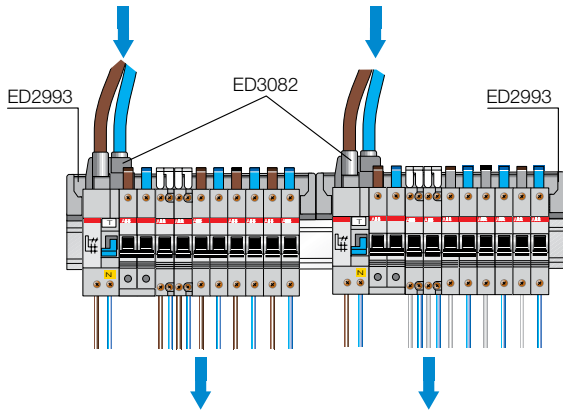

Busbars supplied by means of terminals installed centrally

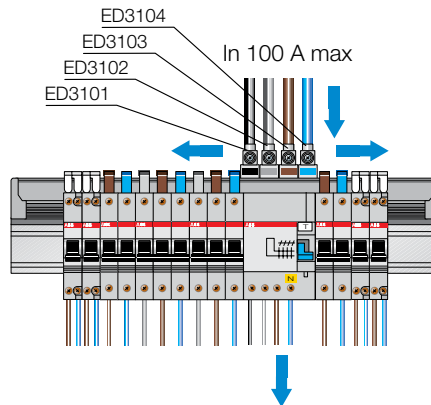

Example of main and branched power supply

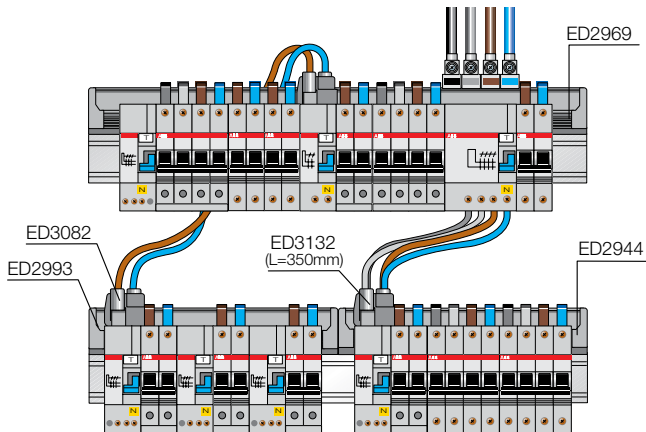

Busbars supplied from above by means of terminals installed laterally

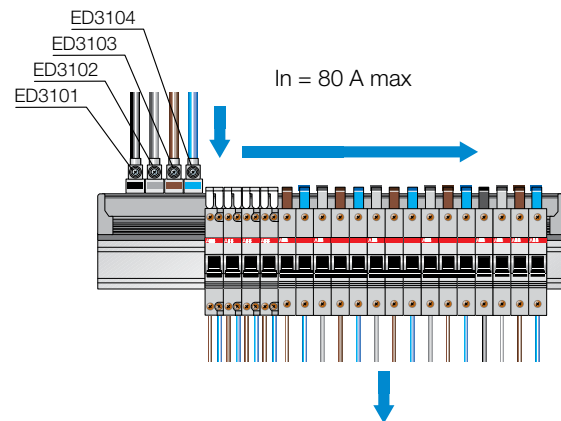

Busbars supplied by means of cable terminal under the head of the circuit-breaker's terminal and branching with parallel module

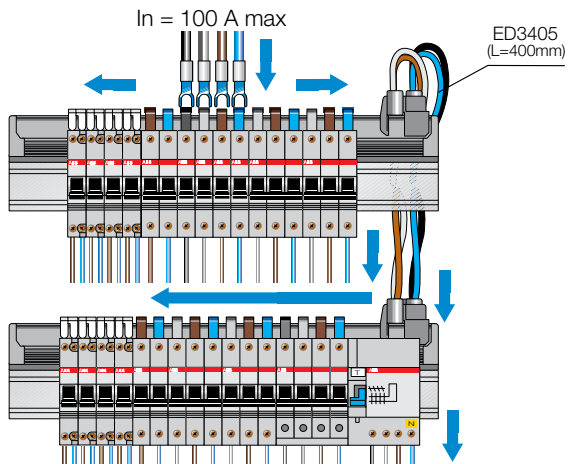

Busbars supplied directly by means of feeder module (supplied without cables) and branching by means of feeder module

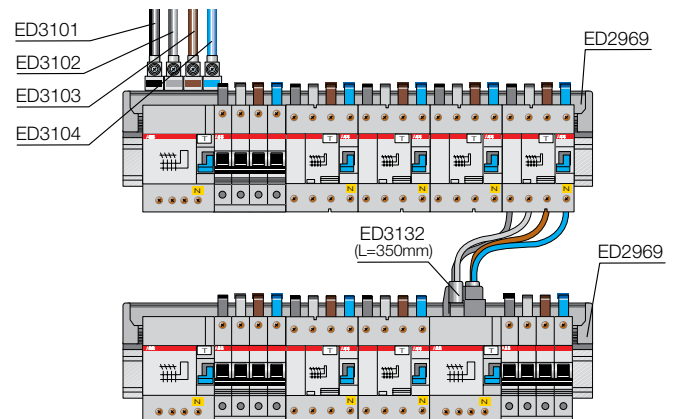

System pro E power

Technical details and certifications

Configuration examples

2000x800x300mm (HxLxP) structure with H=100mm plinth, internal cable compartment, IP65 protection class. 1000A vertical busbar system installed at the side of the cable compartment. T6 main circuit-breaker fixed vertically. Fixed frame. T4 circuit-breaker kit fixed horizontally, No. 3 XT1 fixed horizontally.

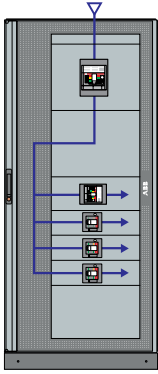

7

Quantity	Order code	Description	Reference chapter
1	PUPM2000	No.4 galvanized sheet metal uprights H=2000mm	Structure
1	PUCM2000	No. 4 galvanized sheet metal cross-pieces L=800mm	Structure
1	PCFM0800	No. 4 galvanized sheet metal cross-pieces L/D=300mm	Structure
1	PCFM0300	No. 4 galvanized sheet metal plinth angle pieces H=100mm	Structure
1	PPAM0100	No. 2 front/rear plinth flanges H=100mm L=800mm	Structure
1	PPFM1080	No. 2 side plinth flanges H=100mm L/D=300mm	Structure
1	PPFM1030	Blind Top/Bottom IP65 L=800mm d=300mm	Structure
1	PTBB8036	Open Top/Bottom IP65 L=800mm d=300mm	Structure
1	PTBO8030	Incoming cable flange 800x300mm	Structure
1	PFCF8030	External cover IP65 H=2000mm L=800mm	Structure
1	PPEB2086	External cover IP65 H=2000mm L/D=300mm	Structure
2	PPEB2036	Blind door for int.cable comp. H=2000mm L=200mm	Structure
1	PDCB2020	Glass door IP65 H=2000mm L=800mm	Structure
1	PDLG2062	Upright for cable comp. in galv. sheet metal H=2000mm	Structure
1	PPPF2060	Fixed frame for panels H=2000mm L=600	Internal kits
1	PVCT6401	Kit with 3-4P T6 fixed vertical installation L=600mm	Internal kits
1	PHCT4406	Kit with 3-4P T4 fixed horizontal installation L=600mm	Internal kits
3	PHCX1401	Kit with 3-4P XT1 fixed horizontal installation L=600mm	Internal kits
1	PPFB1560	Flat blind panel H=150mm L=600mm	Internal kits
2	PPFB4060	Flat blind panel H=400mm L=600mm	Internal kits
8	PBFC4005	Flat copper bar 40x5 L=1750mm	Main distribution systems
2	PCRM0238	No. 2 galvanized sheet metal cross-pieces L=238mm	Main distribution systems
2	PBHB1125	No. 24 busbar insulating supports L=50mm	Main distribution systems
2	PTRN1951	No. 10 nylon tie rods L=195mm for In<4000A	Main distribution systems
2	PCRM0288	No. 2 galvanized sheet metal cross-pieces L=288mm	Main distribution systems
1	PBBV0008	No. 8 busbar plates vertical side	Main distribution systems

Configuration examples

1800x600x300mm (HxLxP) structure without plinth, IP65 protection class. 630A vertical busbar system installed at the rear of the structure. T5 main circuit-breaker fixed vertically. Kit with No.2 XT2 circuit-breakers fixed vertically.

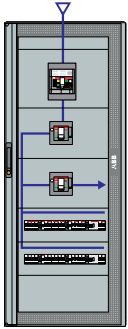

Quantity	Order code	Description	Reference chapter
1	PUPM1800	No. 4 galvanized sheet metal uprights H=1800mm	Structure
1	PCFM0600	No. 4 galvanized sheet metal cross-pieces L=600mm	Structure
1	PCFM0300	No. 4 galvanized sheet metal cross-pieces L/D=300mm	Structure
1	PTBB6030	Blind Top/Bottom IP40 L=600mm d=300mm	Structure
1	PBWP6030	Internal bottom IP40 L=600mm D=300mm	Structure
1	PPEB1860	External rear cover IP40 H=1800mm L=600mm	Structure
2	PPEB1830	External side cover IP40 H=1800mm L/D=300mm	Structure
1	PDLG1860	Glass door IP40 H=1800mm L=600mm	Structure
1	PFPF1860	Fixed frame for panels H=1800mm L=600	Internal kits
1	PVCT5406	Kit with 3-4P T5 fixed+vertical (400/630A)mrd L=600mm	Internal kits
2	PVCX2401	Kit with 3-4P XT2 fixed vertical installation L=600mm	Internal kits
2	PDRS0600	Standard DIN rail L=600mm	Internal kits
2	PPMF2060	Panel with 24 DIN modules H=200mm L=600mm	Internal kits
1	PPFB1560	Flat blind panel H=150mm L=600mm	Internal kits
1	PPFB3060	Flat blind panel H=300mm L=600mm	Internal kits
2	PBFC5005	Flat copper bar 50x5 L=1750mm	Main distribution systems
3	PCRM0238	No. 2 galvanized sheet metal cross-pieces L=238mm	Main distribution systems
2	PBHB1125	No. 24 busbar insulating supports L=50mm	Main distribution systems
3	PTRN1951	No. 10 nylon tie rods L=195mm for In<4000A	Main distribution systems
3	PCRM0588	No. 2 galvanized sheet metal cross-pieces L=588mm	Main distribution systems
2	PBBV0008	No. 8 busbar plates vertical side	Main distribution systems

System pro E power

Technical details and certifications

Configuration examples

2000x800x500mm (HxLxP) structure with H=100mm plinth, internal cable compartment, IP65 protection class. 1600A vertical busbar system installed at the side of the structure. T7 main circuit-breaker fixed vertically. Swing frame. Horizontal removable T6 kit, horizontal removable T5, horizontal removable XT4.

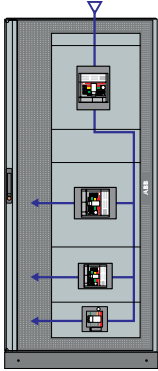

7

Quantity	Order code	Description	Reference chapter
1	PUPM2000	No. 4 galvanized sheet metal uprights H=2000mm	Structure
1	PCFM0800	No. 4 galvanized sheet metal cross-pieces L=800mm	Structure
1	PCFM0500	No. 4 galvanized sheet metal cross-pieces L/D=500mm	Structure
1	PPAM0100	No. 4 galvanized sheet metal plinth angle pieces H=100mm	Structure
1	PPFM1080	No. 2 front/rear plinth flanges H=100mm L=800mm	Structure
1	PPFM1050	No. 2 side plinth flanges H=100mm L/D=500mm	Structure
2	PTBB8056	Blind Top/Bottom IP65 L=800mm d=500mm	Structure
1	PPEB2086	External cover IP65 H=2000mm L=800mm	Structure
2	PPEB2056	External cover IP65 H=2000mm L=500mm	Structure
1	PDCB2020	Blind door for int.cable comp. H=2000mm L=200mm	Structure
1	PDLG2062	Glass door IP65 H=2000mm L=800mm	Structure
1	PUCM2000	Upright for cable comp. in galv. sheet metal H=2000mm	Structure
1	PCCM0500	No. 2 galvanized sheet metal cross-pieces VC D=500mm	Structure
2	PUKI2000	Swing frame for panels H=2000mm L=600	Structure
1	PFPS2060	Int. kit intermediate upright H=2000mm	Structure
1	PVCT7419	Kit with 3-4P T7 fixed vertical installation L=600mm	Internal kits
1	PHCT6410	Kit with 3-4P T6 removable horizontal installation L=600mm	Internal kits
1	PHCT5414	Kit with 3-4P T5 removable (400A) horizontal installation L=600mm	Internal kits
1	PHCX4410	Kit with 3-4P XT4 removable horizontal installation L=600mm	Internal kits
1	PPFB1560	Flat blind panel H=150mm L=600mm	Internal kits
1	PPFB2060	Flat blind panel H=200mm L=600mm	Internal kits
4	PBFC1001	Flat copper bar 100x10 L=1750mm	Main distribution systems
3	PCRM0238	No. 2 galvanized sheet metal cross-pieces L=238mm	Main distribution systems
1	PBHB1125	No. 24 busbar insulating supports L=50mm	Main distribution systems
2	PTRN1951	No. 10 nylon tie rods L=195mm for In<4000A	Main distribution systems
1	PBBV0008	No. 8 busbar plates vertical side	Main distribution systems
1	PCBS1560	Blind compartment H=150mm W=600mm	Segregations
1	PPVS2450	No.2 lateral segregation cell H=450mm	Segregations
1	PCBS2060	Blind compartment H=200mm W=600mm	Segregations
1	PPVS2500	No.2 lateral segregation cell H=500mm	Segregations
1	PPVS2350	No.2 lateral segregation cell H=350mm	Segregations
1	PPVS2250	No.2 lateral segregation cell H=250mm	Segregations
4	PSHS1906	Horizontal shelf W=600mm	Segregations

Configuration examples

2000x600x700mm + 2000x1000x700 (HxLxP) structure with H=100mm plinth, L400mm cable compartment inside the L=1000mm structure, IP40 protection class. 2500A horizontal busbar system at any height in the unit L=600mm and vertically on the side of the structure L=1000mm. E2.2 removable main circuit-breaker fixed vertically. Fixed frame. Kit with horizontal removable 4-pole T7, horizontal removable 4-pole T6, 2 horizontal removable XT2.

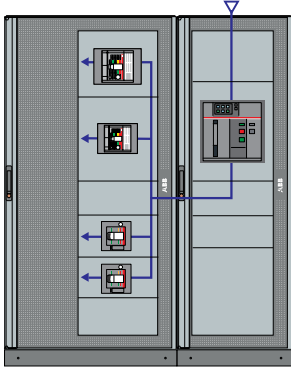

Quantity	Order code	Description	Reference chapter
2	PUPM2000	No. 4 galvanized sheet metal uprights H=2000mm	Structure
1	PCFM1000	No. 4 galvanized sheet metal cross-pieces L=1000mm	Structure
1	PCFM0600	No. 4 galvanized sheet metal cross-pieces L=600mm	Structure
2	PCFM0700	No. 4 galvanized sheet metal cross-pieces D=700mm	Structure
2	PPAM0100	No. 4 galvanized sheet metal plinth angle pieces H=100mm	Structure
1	PPFM1010	No. 2 front/rear plinth flanges H=100mm L=1000mm	Structure
1	PPFM1070	No. 2 side plinth flanges H=100mm D=700mm	Structure
1	PPFM1060	No. 2 front/rear plinth flanges H=100mm L=600mm	Structure
1	PTBB6070	Blind Top/Bottom IP40 L=600mm D=700mm	Structure
1	PTBO6070	Open Top/Bottom IP65 L=600mm D=700mm	Structure
2	PTBB1070	Blind Top/Bottom IP40 L=1000mm D=700mm	Structure
1	PPEB2060	External cover IP30/40 H=2000mm L=600mm	Structure
1	PPEB2010	External cover IP30/40 H=2000mm L=1000mm	Structure
2	PPEB2070	External cover IP30/40 H=2000mm D=700mm	Structure
1	PDLG2060	Glass door IP40 H=2000mm L=600mm	Structure
1	PDLG2640	Glass door IP40 H=2000mm L=1000mm	Structure
1	PUCM2000	Galvanized sheet metal cable uprights H=2000mm	Structure
1	PCCM0700	2 galvanized sheet metal cross-pieces D=700mm	Structure
1	PDCB2040	Blind door for int.cable comp. H=2000mm L=400mm	Structure
1	PSBS0040	Kit for joining side structures IP40	Structure
5	PUKI2000	Internal kit intermediate upright H=2000mm	Structure
2	PPFF2060	Fixed frame for panels H=2000mm L=600	Structure
1	PPFB6060	Flat blind panel H=600mm L=600mm	Internal kits
1	PPFB4060	Flat blind panel H=400mm L=600mm	Internal kits
3	PPFB2060	Flat blind panel H=200mm L=600mm	Internal kits
1	PPFB3060	Flat blind panel H=300mm L=600mm	Internal kits
1	PVCE2450	Kit with vertical 3-4 pole Emax E2.2 600x600	Internal kits
1	PHCT7430	Kit with 3-4P T7 removable horizontal installation L=600mm	Internal kits
1	PHCT6410	Kit with 3-4P T6 removable horizontal installation L=600mm	Internal kits
2	PHCX2410	Kit with 3-4P XT2 removable horizontal installation L=600mm	Internal kits
1	PPMB6060	Blind mounting plate H=600mm W=600mm	Internal kits
12	PBFC1001	Flat copper bar 100x10 L=1750mm	Main distribution systems
3	PCRM0338	No. 2 galvanized sheet metal cross-pieces L=338mm	Main distribution systems
1	PCRM0588	No. 2 galvanized sheet metal cross-pieces L=588mm	Main distribution systems
2	PBHB2145	No. 24 busbar insulating supports L=75mm	Main distribution systems
3	PTRN1951	No. 10 nylon tie rods L=195mm for In<4000A	Main distribution systems
3	PCRM0438	No. 2 galvanized sheet metal cross-pieces L=438mm	Main distribution systems
1	PBBH0004	No. 4 busbar plates at all heights	Main distribution systems
1	PBBV0008	No. 8 busbar plates vertical side	Main distribution systems

CONTINUES

System pro E power

Technical details and certifications

Quantity	Order code	Description	Reference chapter
2	PSHW5061	Segregation for Form 2a-3a T7 withdrawable H=500mm W=600mm	Segregations
2	PSVS0055	Segregations for horizontal breakers terminals H=500mm D=700mm	Segregations
2	PCVS5060	Cubicles Form 4b T7 withdrawable H=500mm W=600mm	Segregations
5	PCBS2060	Blind Compartment H=200mm W=600mm	Segregations
5	PPBS0200	Lateral segregation for blind compartment H=200mm	Segregations
1	PSVS0207	Rear segregation for blind compartment H=200mm	Segregations
1	PCBS3060	Blind compartment H=300mm W=600mm	Segregations
1	PPBS0300	Lateral segregation for blind compartment H=300mm	Segregations
1	PSVS0307	Rear segregation for blind compartment H=300mm	Segregations
2	PPVS2250	N.2 lateral cell segregations H=250mm	Segregations
2	PSVS2570	Segregation for horizontal breakers terminals H=250mm D=700mm	Segregations
2	PCVS1256	Cubicles P1 for breakers kit H=250mm W=600mm	Segregations
2	PRVS1061	Rear segregation for structure busbars side H=1000mm W=600mm	Segregations
1	PPVS2600	No.2 lateral cell segregations H=600mm	Segregations
1	PSWW6062	Segregation 2a-3a E2.2 withdrawable H=600mm W=600mm	Segregations
1	PSHW6072	Horizontal segregation 3b E2.2 withdrawable L=600mm D=700mm	Segregations
1	PRVS3060	Rear segregation H=300MM W=600MM for structure without intermediate upright	Segregations
2	PMCS3070	No.2 lateral connection modules H=300mm D=700mm	Segregations
2	PBMC0002	No.2 fixing brackets for connection modules	Segregations
2	PLVS4072	Rear lateral segregation for compartment H=400MM D=700MM for structure with rear intermediate upright	Segregations
1	PRVS7060	Segregazione verticale posteriore H=700MM W=600MM for structure without rear intermediate upright	Segregations
1	PRVS1060	Segregazione verticale posteriore H=1000MM W=600MM for structure without rear intermediate upright	Segregations
7	PSHS1906	Horizontal shelf W=600mm	Segregations

System pro *E* power

Overall dimensions

Frame	8/2
Internal cable compartment	8/3
Intermediate upright	8/3
Adjacent structures	8/3
External covers	8/4
Internal kit	8/7
Main distribution systems	8/11
Segregations	8/16

System pro E power

Overall dimensions

Frame

Front

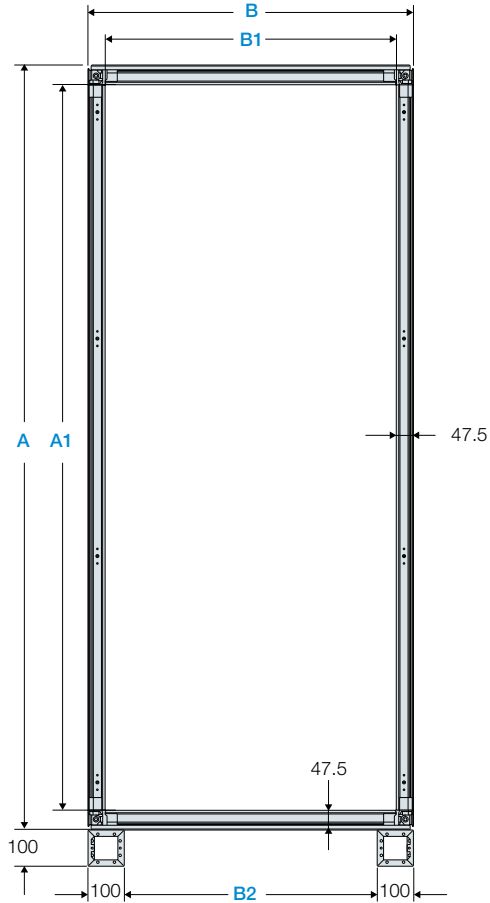

Side

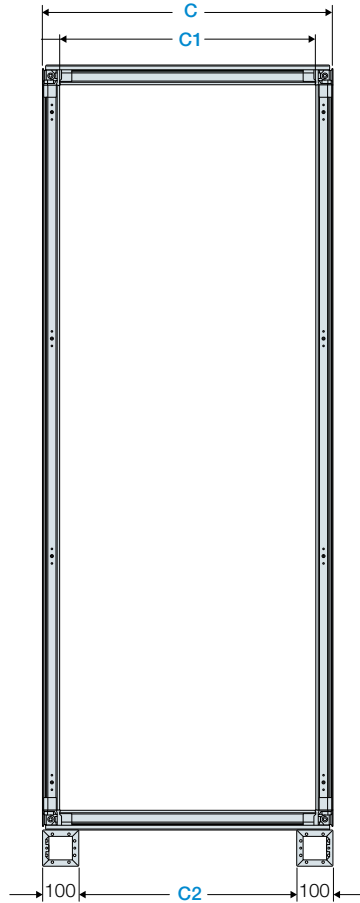

Height measurements (mm)

A A1

1913 1804

2113 2004

Width measurements (mm)

B B1 B2 B3 B4 B5 B6 B7 B8

399 304 198 337 375 244 321 398 276

499 404 298 437 475 344 421 498 376

699 604 498 637 675 544 621 698 576

899 804 698 837 875 744 821 898 776

1099 1004 898 1037 1075 944 1021 1098 976

1349 1254 1148 1287 1325 1194 1271 1348 1226

Depth measurements (mm)

C C1 C2 C3 C4 C5 C6 C7 C8

299 204 98 237 275 144 221 298 176

399 304 198 337 375 244 321 398 276

599 504 398 537 575 444 521 598 476

799 704 598 737 775 644 721 798 676

999 904 798 937 975 844 921 998 876

8

Bottom

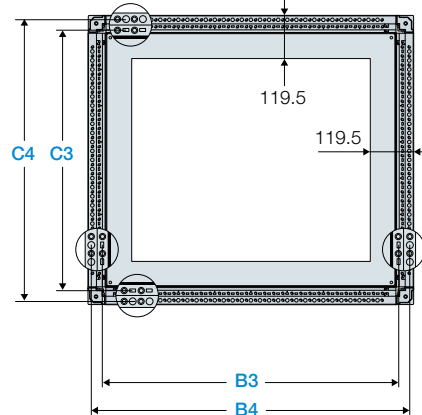

Fixing on floor

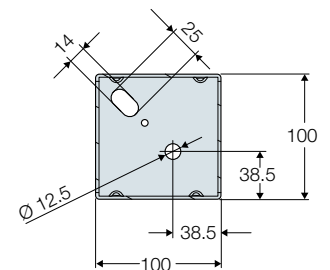
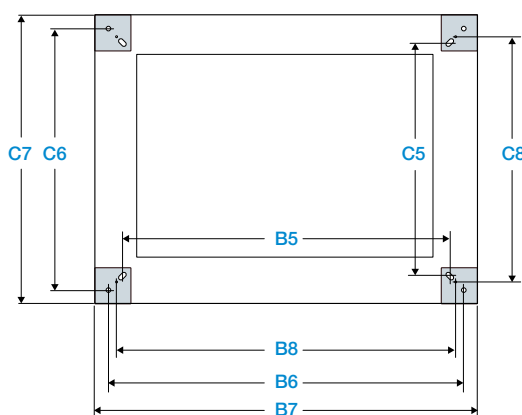

> The measurements are given in millimeters

Internal cable compartment

Front

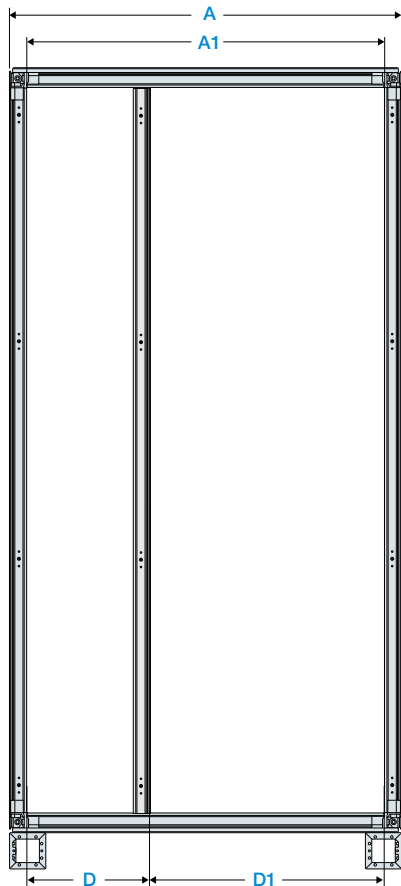

A	A1	D	D1
699	604	200	404
899	804	200	604
		400	404
1099	1004	200	804
		400	604

Intermediate upright

Side

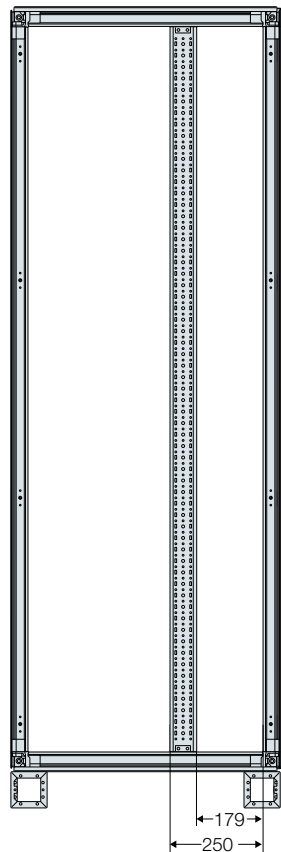

Overall dimensions for several adjacent structures

Front

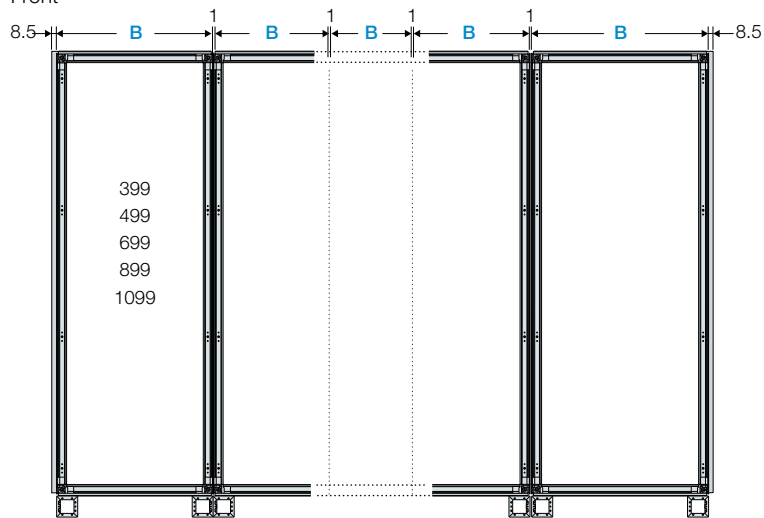

Side

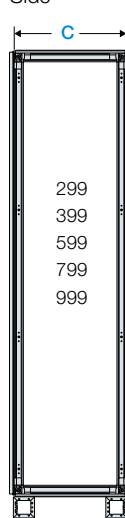

Total width calculation

- 1- add 1mm to the width of the columns $(B+1) + (B+1)...$
- 2- add 17mm for the 2 side panels $(8.5+8.5=17\text{mm})$
- 3- subtract 1mm from the total (-1mm)

Example

$$(699+1) + (899+1) + (699+1) + 17 - 1 = 2.316$$

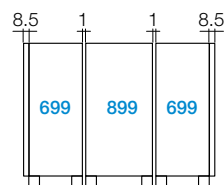

Total depth calculation

Add 48mm to the depth of the structure (C), corresponding to the front and rear covers.

C (depth of the structure) + 48mm (front and rear covers including handle)

> The measurements are given in millimeters

System pro E power

Overall dimensions

External covers

Glass doors

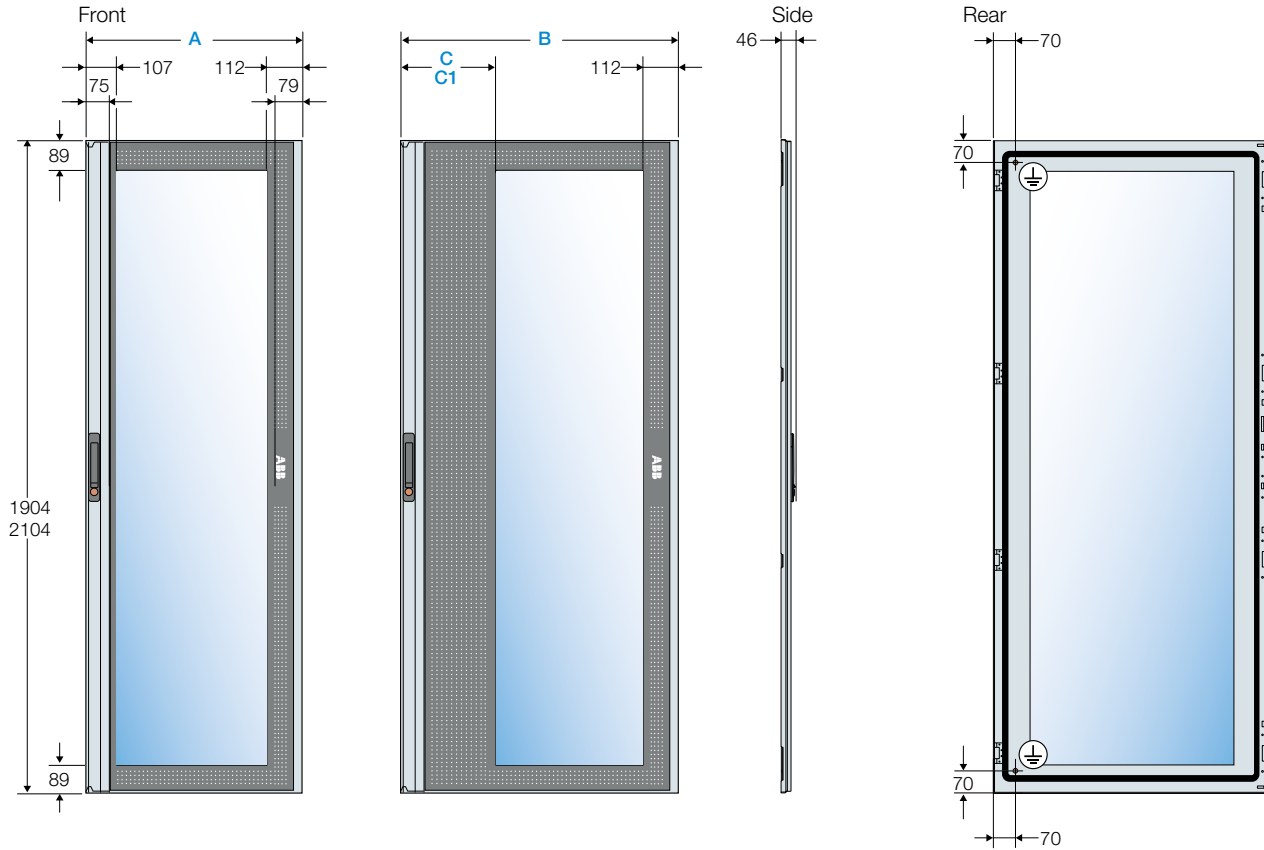

8

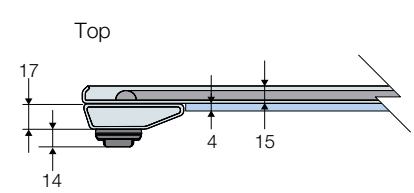

A	B	C	C1
494	-	-	-
694	-	-	-
894	894	307	-
1094	1094	307	507

> The measurements are given in millimeters

External covers

Blind doors

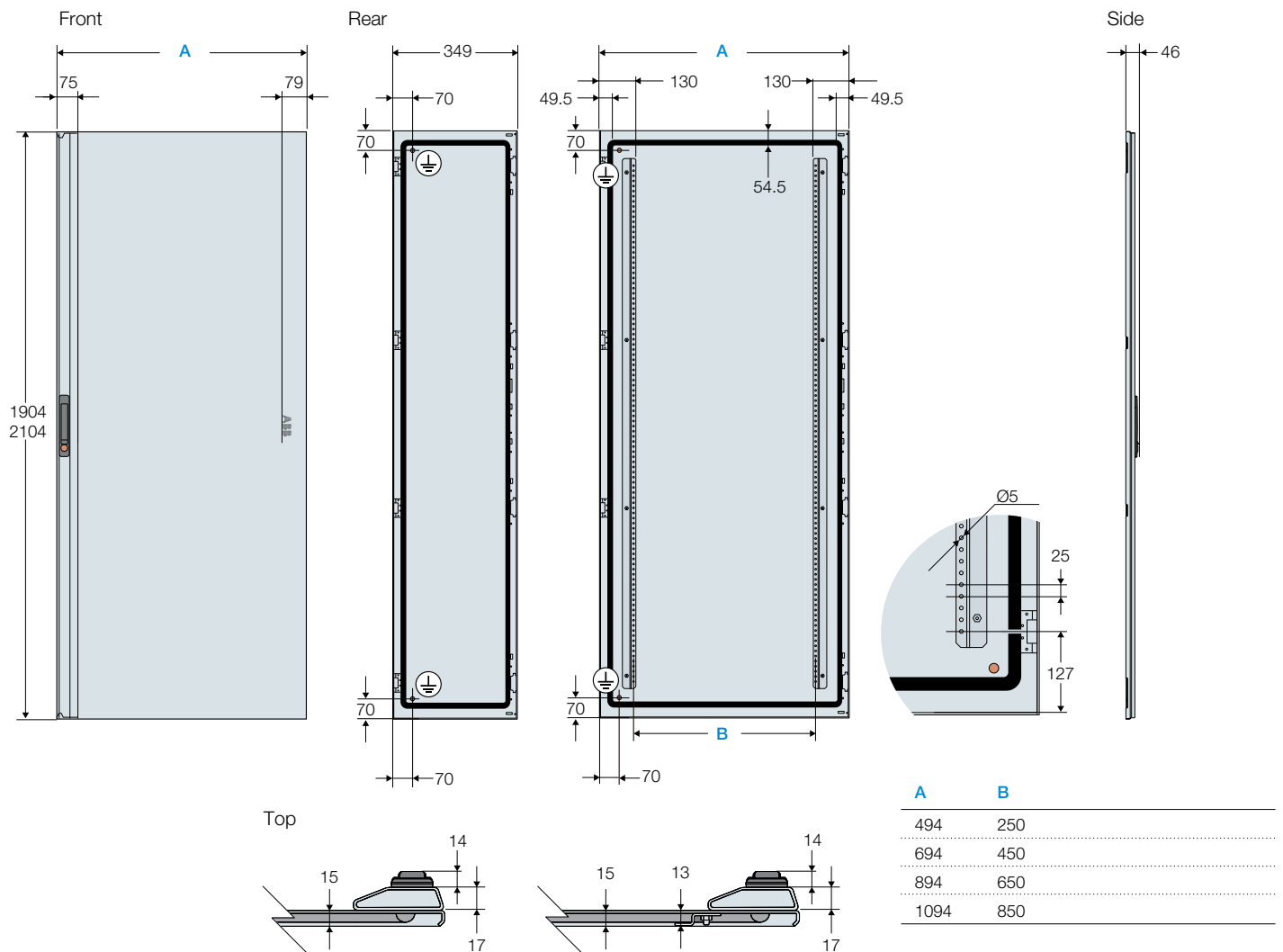

> The measurements are given in millimeters

System pro E power

Overall dimensions

External covers

Rear, side panels

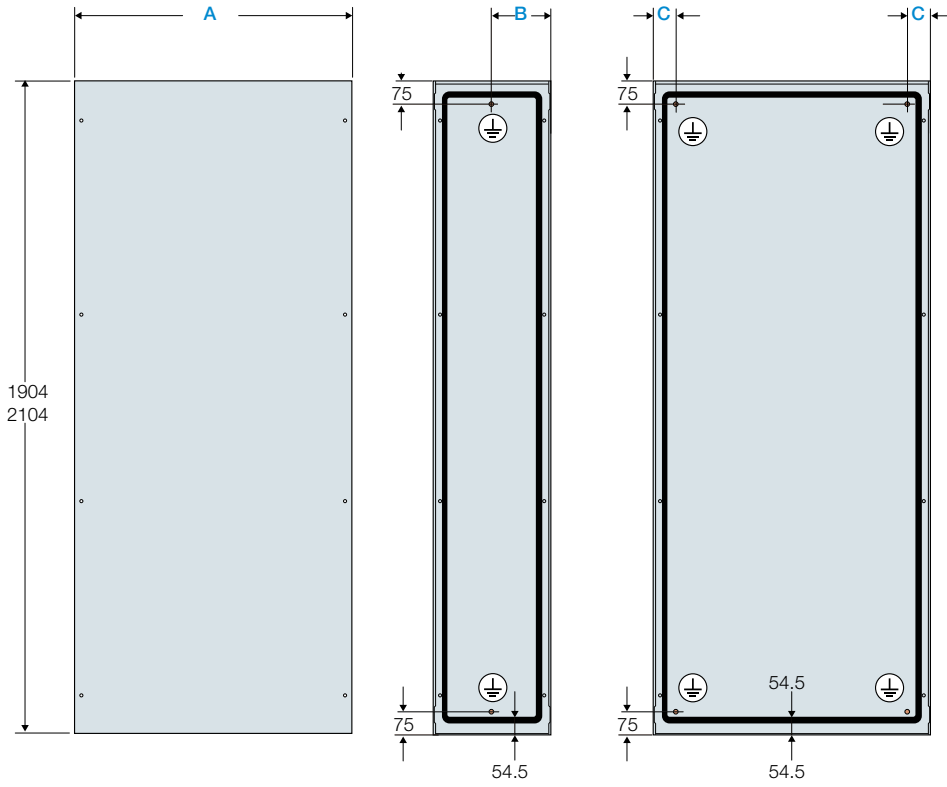

Rear panels			Side panels		
A	B	C	A	B	C
389	194.5		289	144.5	
489	244.5		389	194.5	
689		75	589		75
889		75	789		75
1089		75	989		75

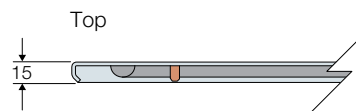

Internal kit Mounting Plates

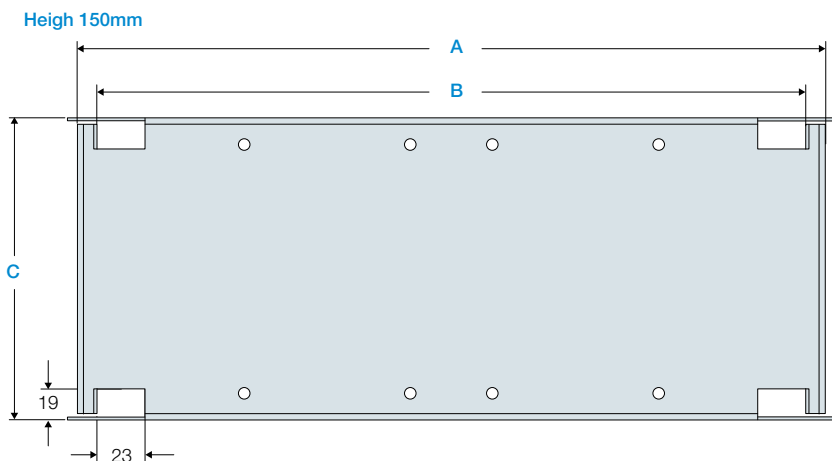

A	B	C
363	344	146
563	544	
763	744	

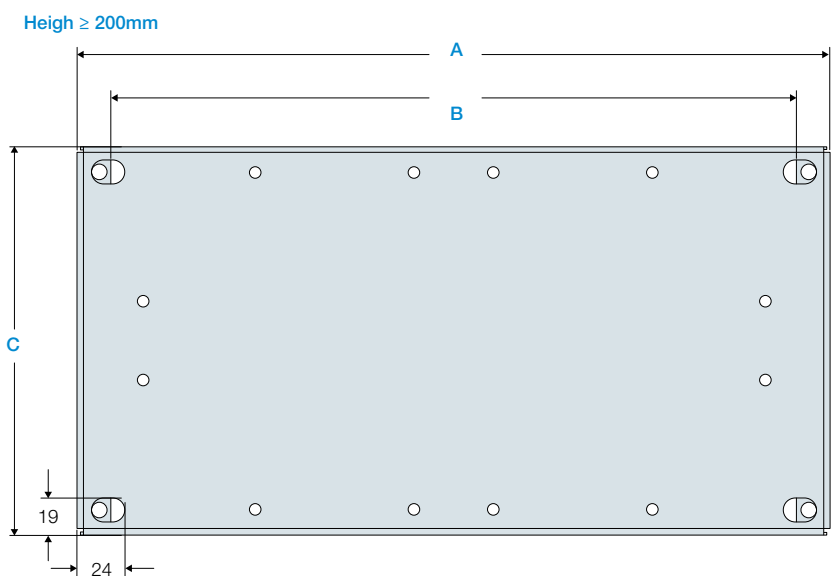

A	B	C
381	347	196
581	547	
781	747	
981	947	
381	347	246
581	547	
781	747	
981	947	
381	347	296
581	547	
781	747	
981	947	
381	347	346
581	547	
781	747	
981	947	
381	347	396
581	547	
781	747	
981	947	
381	347	446
581	547	
781	747	
981	947	
381	347	496
581	547	
781	747	
981	947	
381	347	596
581	547	
781	747	
981	947	

> The measurements are given in millimeters

System pro E power

Overall dimensions

Internal Kit

Flat blind panels

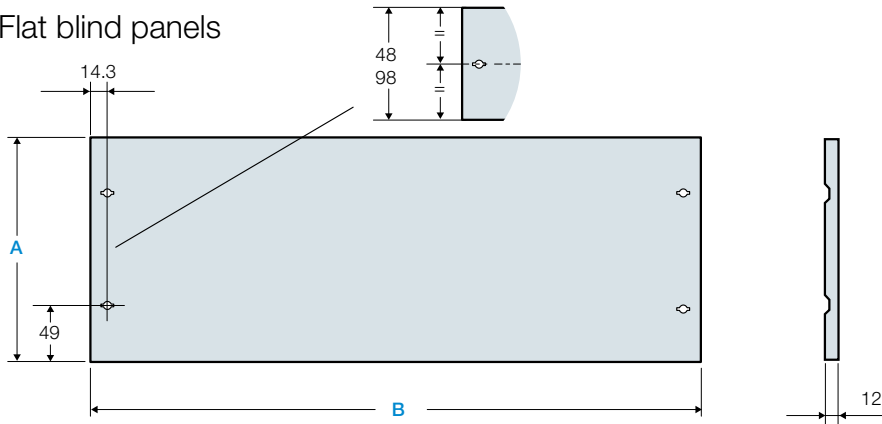

A	B
48	343
98	543
148	743
198	943
248	
298	
398	
498	
598	

Ventilated panels

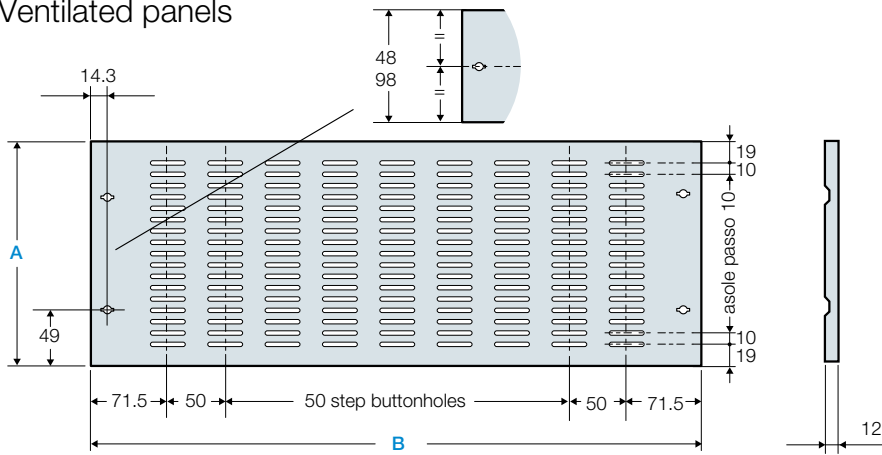

A	B
48	343
98	543
148	743
198	943
248	
298	
398	
498	
598	

Panels Modular DIN Rail

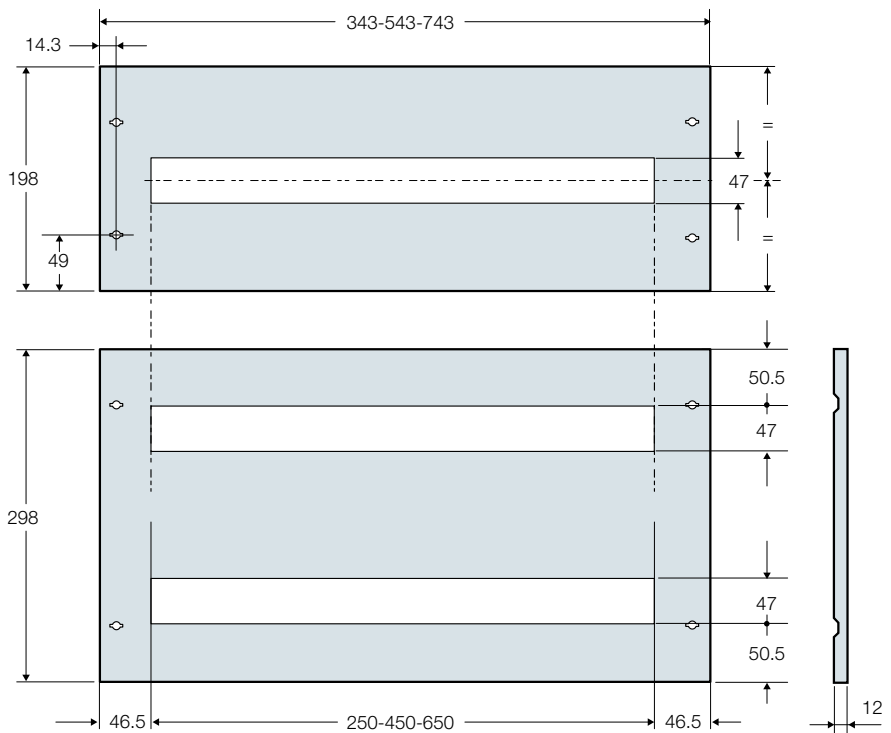

> The measurements are given in millimeters

Internal kit

Panels for square measuring instruments

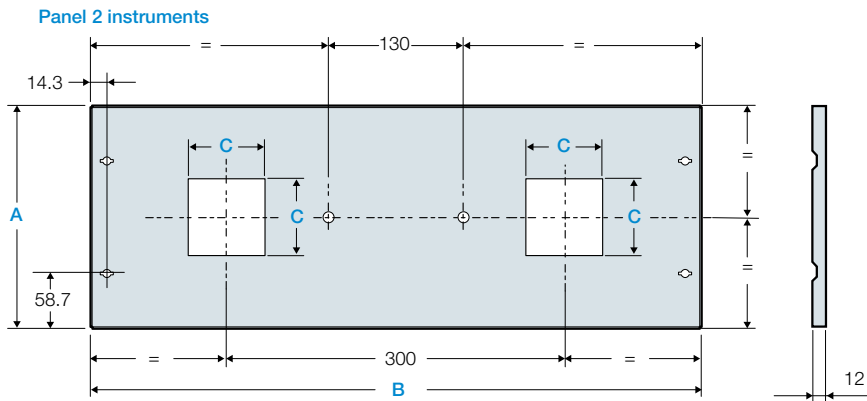

A	B	C
198	543	68
		92
198	743	68
		92

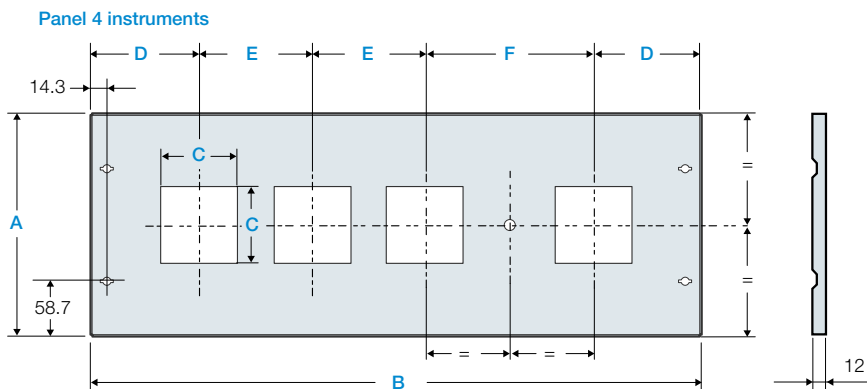

A	B	C	D	E	F
198	543	68	96.5	100	150
198	743	68	196.5	100	150
		92	121.5	150	200

Recessed blind panels

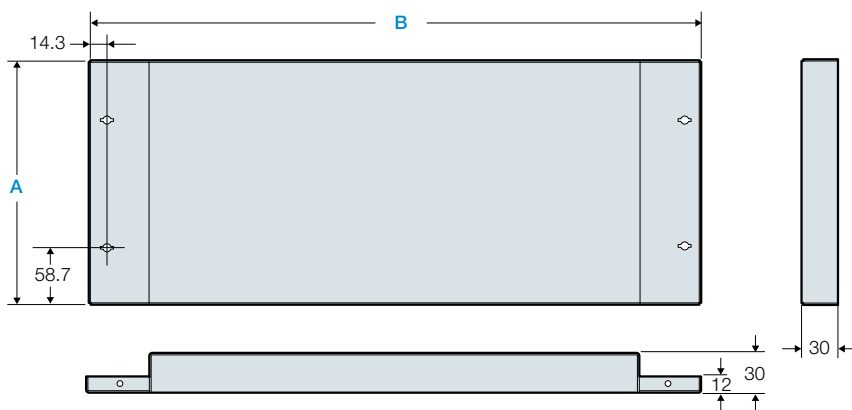

A	B
198	343
398	
598	
198	543
398	
598	
198	743
398	
598	

> The measurements are given in millimeters

System pro E power

Overall dimensions

Internal kit

Useful space inside the switchgear

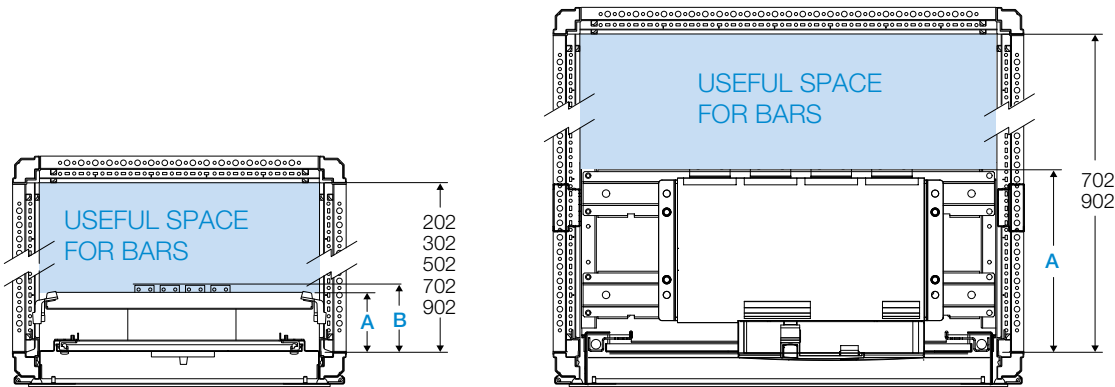

To find the useful space available for the installation of the busbars, according to depth of the structure, subtract the depth of the breaker (A or B) depending on the version shown in the following table.

Tmax T - Tmax XT - Emax 2 E1.2

Execution	F		F - I		F - I-MO		F - MO		F - RC		F - RHD	
Terminals	Front (A)	Rear (B)	Front (A)	Rear (B)	Front (A)	Rear (B)	Front (A)	Rear (B)	Front (A)	Rear (B)	Front (A)	Rear (B)
Circuit-breakers	Depth circuit breaker A (mm)											
XT1-XT3	74	179	139	179	237*	277*	172	277	74	179	108	213
XT2-XT4	86	191	151	191	237*	277*	172	277	86	191	120	225
T4	107	212	172	212	287*	327*	222*	327*	107	212	140,5	245,5
T5	107	242	172	242	287*	357*	222*	357*	107	242	140,5	275,5
T6	107	180	172	180	287*	295*	222*	295*	107	180	140,5	213,5
T7	171	230	171	230	171	230	171	230	171	230	184	243
E1.2	157	216	157	216								

Execution	P (A) (B)		P - I (A) (B)		P - I-MO (A) (B)		P - MO (A) (B)		P - RHD (A) (A)			
XT1	124	204,5	189	204,5	287*	302,5*	222*	302,5*	158	238,5		
XT2	136	216,9	201*	216,9*	287*	302,9*	222*	302,9*	170	250,9		
XT3	124	206,9	189	206,9	287*	304,9*	222*	304,9*	158	240,9		
XT4	136	218,9	201*	218,9*	287*	304,9*	222*	304,9*	170	252,9		
T4												
T5 ⁽¹⁾	157	231,25	222*	231,25*	337*	346,25*	272*	346,25*	190,5	264,75		
T5 ⁽²⁾	157	231,25					272*	346,25*	190,5	264,75		

Execution	W (A) (B)		W - I (A) (B)		W - I-MO (A) (B)		W - MO (A) (B)		W - RHD (A) (B)		
XT2	170	250,9	235*	250,9*	287	302,9	222*	302,9*	170	250,9	
XT4	170	252,9	235*	252,9*	287	304,9	222*	304,9*	170	252,9	
T4											
T5 ⁽¹⁾	190,5	264,75	255,5*	264,75*	337*	346,25*	272*	346,25*	190,5	264,75	
T5 ⁽²⁾	190,5	264,75					272*	346,25*	190,5	264,75	
T6	190,5	271	255,5*	271*	337*	352,5*	272*	352,5*	190,5	271	
T7	251	297	251*	297*	251*	297*	251*	297*	251*	297*	
E1.2	251	300	251	300							

⁽¹⁾ Tmax T5 400A ⁽²⁾ Tmax T5 630A *Breakers with recessed mounting plate.

Emax 2

Accessorized or not accessorized, only rear terminals.

Execution	F	W
Circuit-breakers	Depth circuit breaker A (mm)	
E2.2	291	405
E4.2	291	405
E6.2	291	405

Key:

F	fixed	P - RC	plug-in with residual current
F - I	fixed interlocked	P - RHD	plug-in with Direct Rotary Handle
F - I-MO	fixed interlocked motor-operated	W	withdrawable
F - MO	fixed motor-operated	W - I	withdrawable interlocked
F - RC	fixed with residual current	W - I-MO	withdrawable interlocked motor-operated
F - RHD	fixed with Direct Rotary Handle	W - MO	withdrawable motor-operated
F & F - I	fixed and fixed interlocked	W - RC	withdrawable with residual current
P	plug-in	W - RHD	withdrawable with Direct Rotary Handle
P - I	plug-in interlocked	W & W - I	withdrawable and withdrawable interlocked
P - I-MO	plug-in interlocked motor-operated		
P - MO	plug-in motor-operated		

> The measurements are given in millimeters

Main distribution systems
Shaped profile busbars

PBSC0400
In 400A

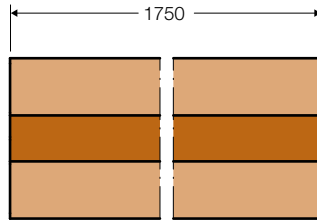
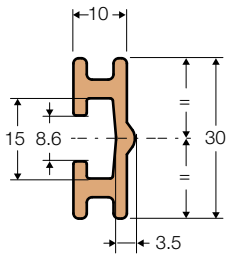

PBSC1000
In 1000A

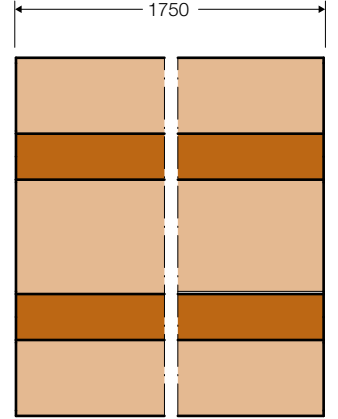
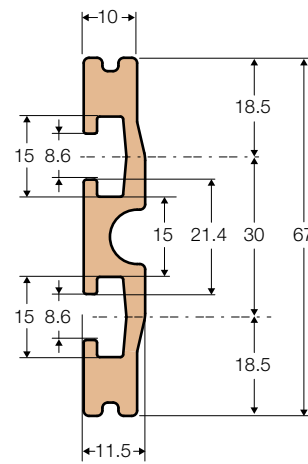

PBSC0630
In 630A

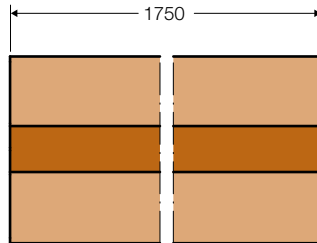
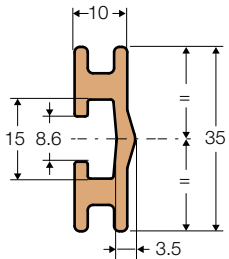

PBSC1250
In 1250A

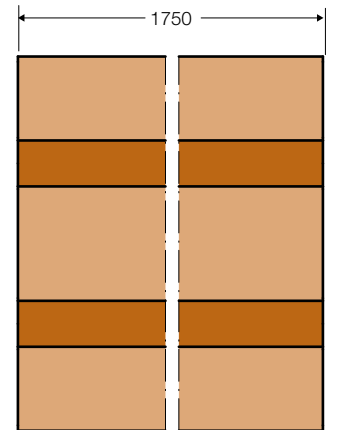
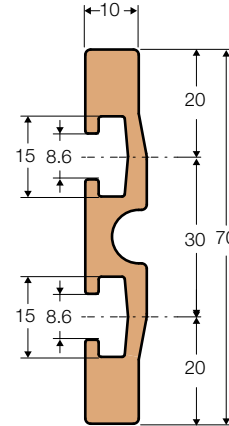

PBSC0800
In 800A

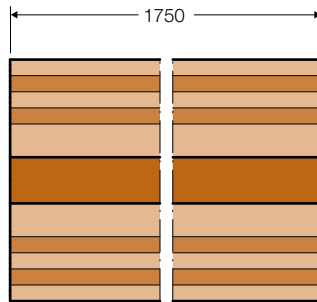
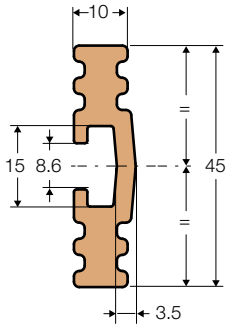

> The measurements are given in millimeters

System pro E power

Overall dimensions

Main distribution systems

Shaped profile busbars

PBSC1600
In 1600A

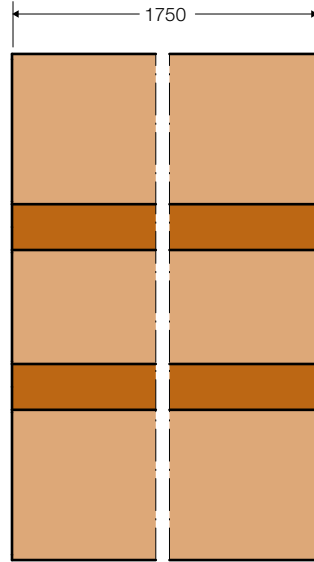
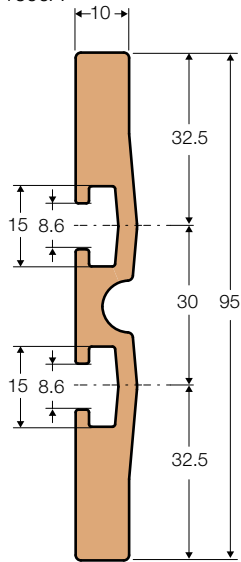

PBSC2500
In 2500A

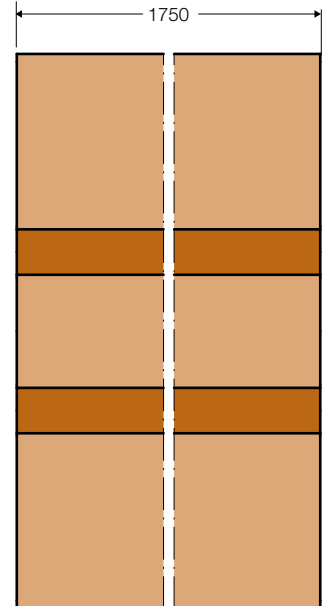
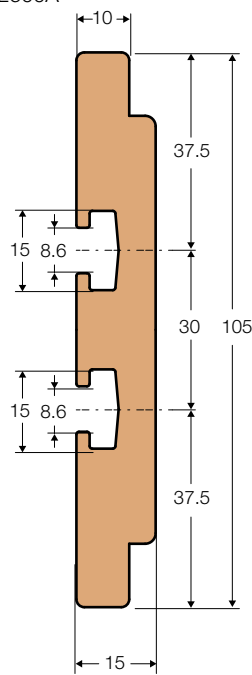

PBSC2000
In 2000A

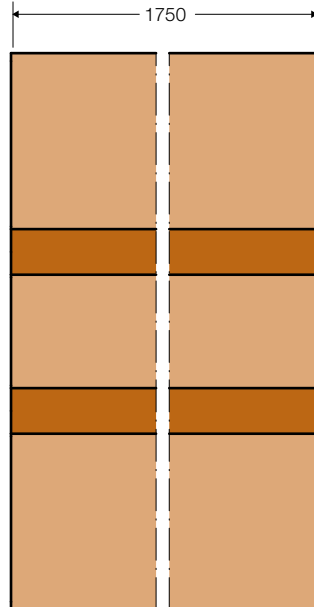
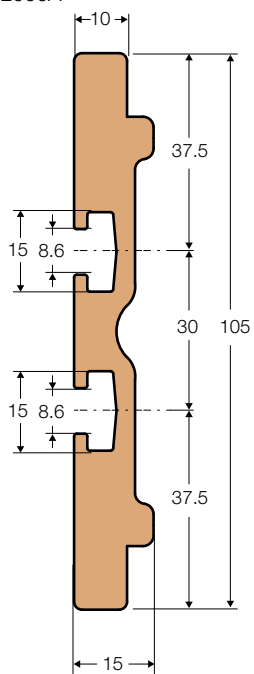

> The measurements are given in millimeters

Main distribution systems

Flat busbars

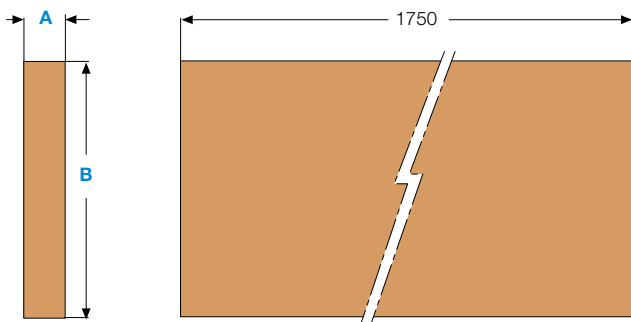
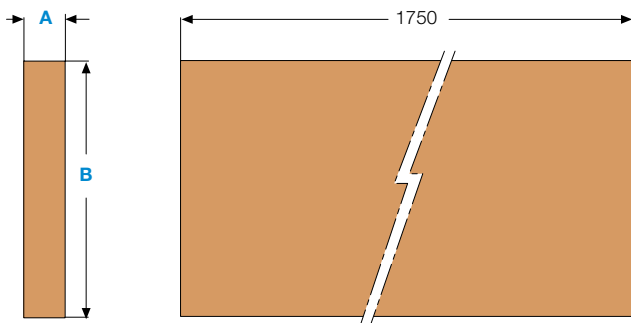
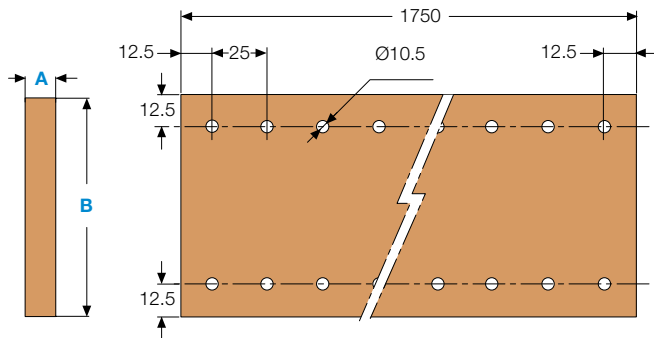
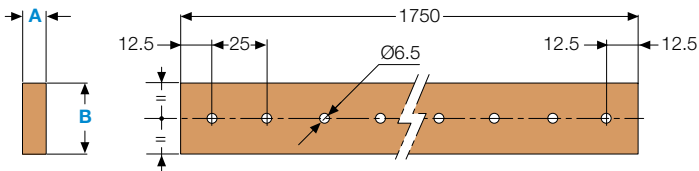

Copper busbars

Code	A	B
PBFC2005	5	20
PBFC2505	5	25
PBFC4005	10	30
PBFC8005	5	40
PBFC3205	5	32

Code	A	B
PBFC1005	5	100
PBFC3010	5	80
PBFC5005	5	50
PBFC6305	5	63

Code	A	B
PBFC1001	10	100
PBFC1201	10	120
PBFC1601	10	160
PBFC2001	10	200
PBFC4010	10	40
PBFC5010	10	50
PBFC6010	10	60
PBFC8010	10	80

Cuponal busbars

Code	A	B
PBFA2005	5	20
PBFA2505	5	25
PBFA3005	5	30
PBFA4005	5	40
PBFA5005	5	50
PBFA6005	5	60
PBFA8005	5	80
PBFA4010	10	40
PBFA5010	10	50
PBFA7510	10	75
PBFA8010	10	80
PBFA1001	10	100
PBFA1201	10	120

> The measurements are given in millimeters

System pro E power

Overall dimensions

Main distribution systems

Linear busbar rails

PBHB1125

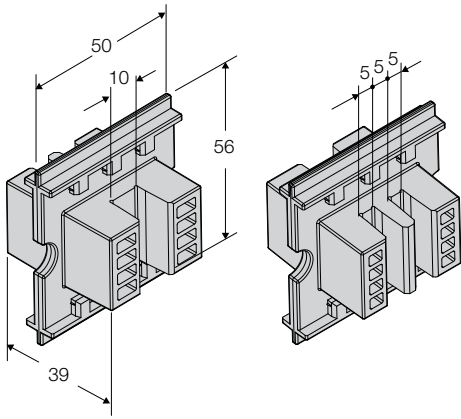

PBHB2145

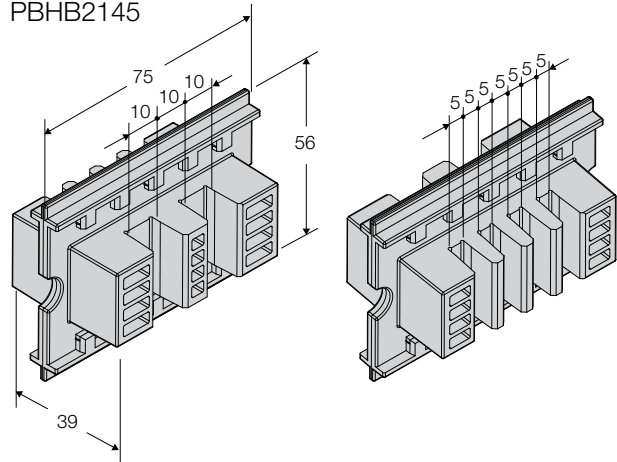

PBHB3121

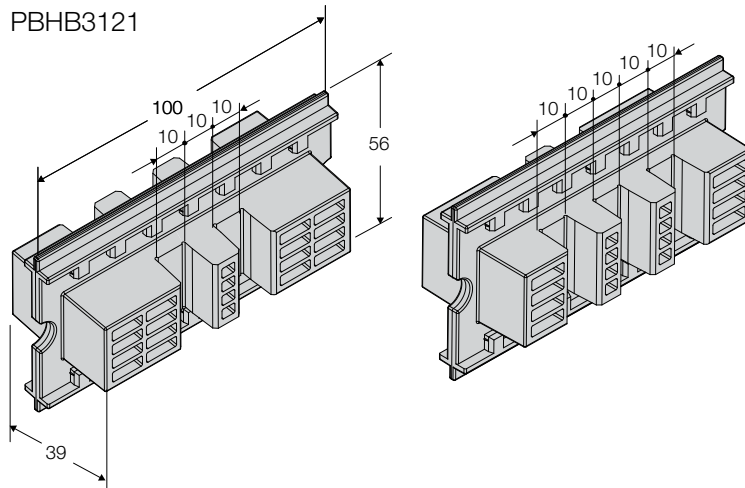

8

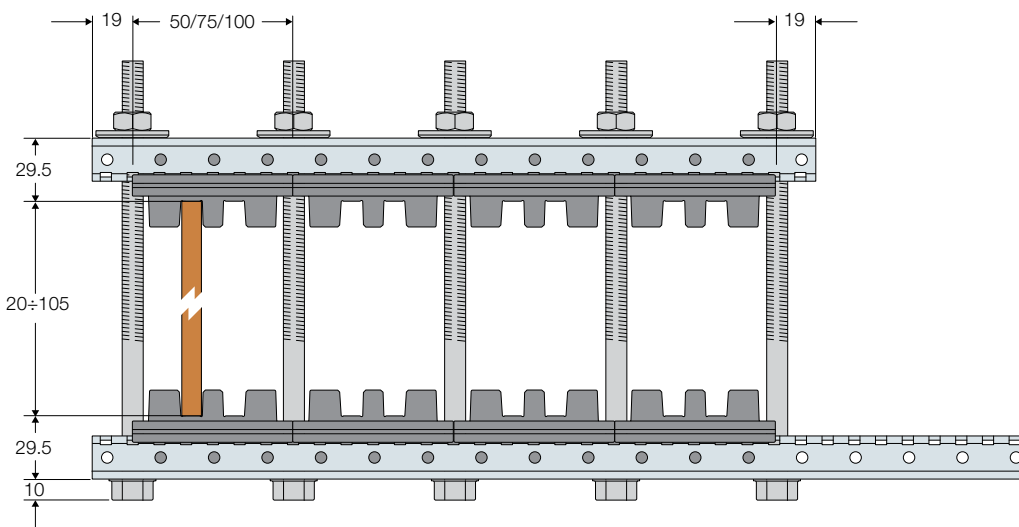

> The measurements are given in millimeters

Main distribution systems

Scaled busbar rails

PBHS1125

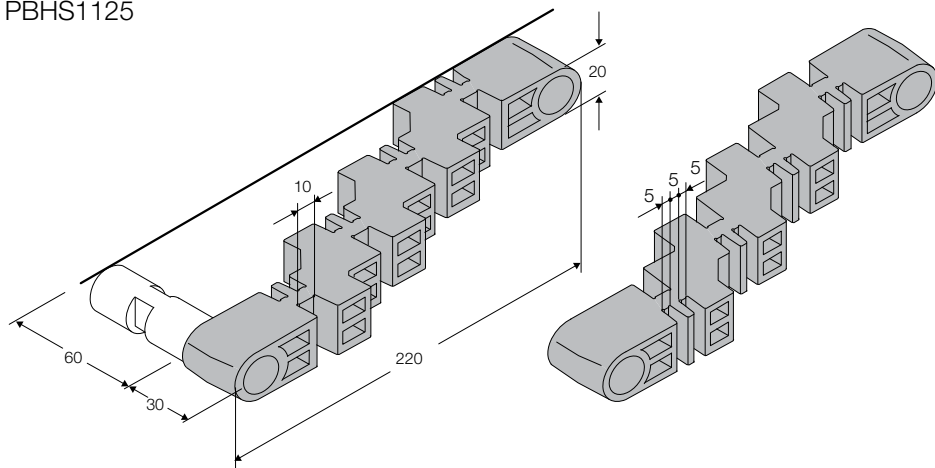

Tie rods

Nylon tie rods

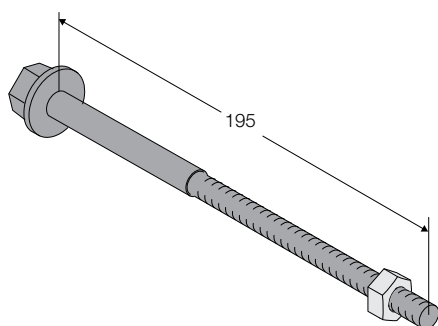

Stainless steel tie rods

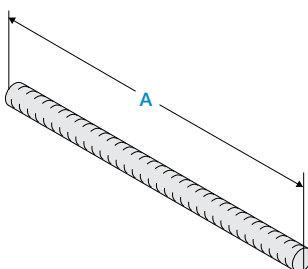

Stainless steel tie rods	A
	210
	250
	290

Crosspieces for insulating supports

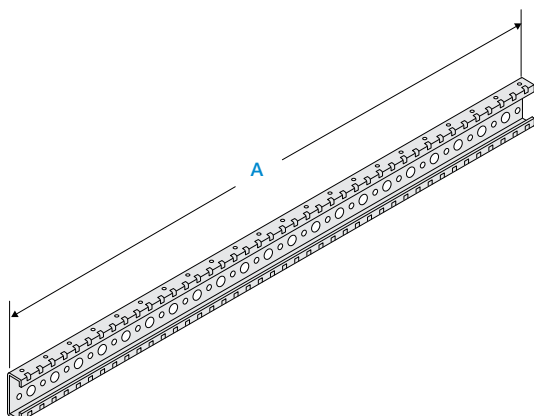

Galvanized sheet metal	Stainless steel	A
PCRM0188		88
PCRM0238		238
PCRM0288		288
PCRM0338	PCRS0338	338
PCRM0388	PCRS0388	388
PCRM0438	PCRS0438	438
PCRM0488		488
PCRM0538		538
PCRM0588	PCRS0588	588
PCRM0638	PCRS0638	638
PCRM0688		688
PCRM0738		738
PCRM0788	PCRS0788	788
PCRM0888	PCRS0888	888
PCRM0988	PCRS0988	988
PCRM1238		1238
PCRM2013	PCRS1238	2013

> The measurements are given in millimeters

System pro E power

Overall dimensions

Segregations

Form 4b segregations

Segregations rear mounting positions

Assembly position **P0**

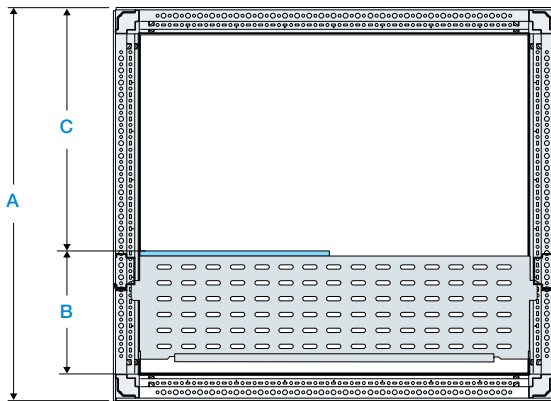

A	B	C
599	244	310
699	244	510
999	244	710

Assembly position **P1**

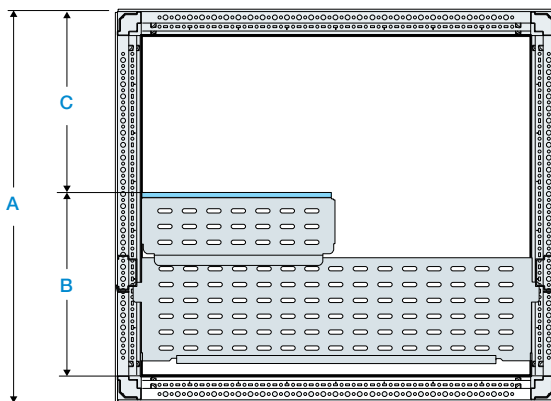

A	B	C
599	364	190
699	364	390
999	364	590

Assembly position **P2**

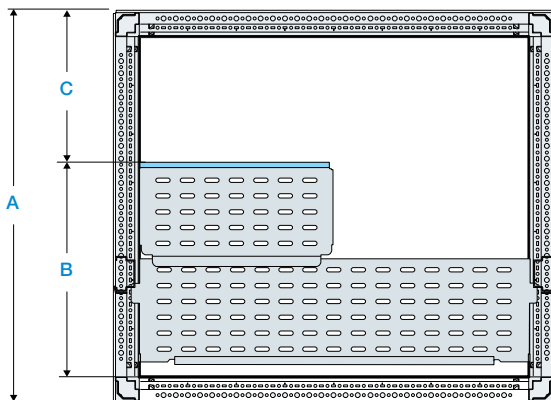

A	B	C
599	434	120
699	434	320
999	434	520

> The measurements are given in millimeters

System pro *E* power

List of codes

System pro E power

List of codes

Code	Page	Weight KG	Code	Page	Weight KG	Code	Page	Weight KG	Code	Page	Weight KG
Code	Page	Weight KG	AD1028	5/43	0,31	ED0004	5/36	0,29	ED2845	5/36	0,05
06652	5/38	0,60	AD1029	5/43	0,41	ED0025	5/37	1,91	ED2852	5/36	0,05
07241	5/39	0,58	AD1030	5/43	0,44	ED0026	5/37	1,33	ED2894	5/35	0,08
07242	5/39	0,70	AD1031	5/43	0,52	ED2183	5/35	3,10	ED2902	5/35	0,06
07243	5/39	0,93	AD1034	5/43	2,00	ED2191	5/35	4,10	ED2910	5/35	0,07
07244	5/39	1,17	AD1037	3/40	0,35	ED2209	5/35	1,45	ED2928	5/35	0,08
07245	5/39	1,67	AD1041	5/41	0,34	ED2217	5/36	0,15	ED2936	5/36	0,03
07246	5/39	2,81	AD1044	5/41	0,99	ED2225	5/36	0,16	ED2944	5/37	0,36
07247	5/39	3,44	AD1053	5/43	2,95	ED2233	5/36	0,18	ED2951	5/37	0,56
07855	5/38	0,76	AD1055	5/41	1,67	ED2241	5/36	0,13	ED2961	5/37	0,40
1SL9816A00	5/38	0,76	AD1056	5/41	0,30	ED2258	5/36	0,20	ED2962	5/37	0,10
1SL9817A00	5/38	0,79	AD1058	2/36	0,01	ED2266	5/36	0,23	ED2969	5/37	0,75
1SL9818A00	5/38	0,97	AD1064	5/41	0,26	ED2274	5/36	0,23	ED2977	5/37	1,09
1SL9819A00	5/38	1,15	AD1071	5/41	0,25	ED2282	5/36	0,18	ED2985	5/37	0,17
1SL9820A00	5/38	1,52	AD1072	5/41	0,32	ED2290	5/36	0,25	ED2993	5/37	0,26
1SL9836A00	5/38	1,03	AD1075	5/43	0,55	ED2308	5/36	0,27	ED3009	5/37	0,39
1SL9837A00	5/38	1,07	AD1076	5/43	0,25	ED2316	5/36	0,29	ED3017	5/37	0,47
1SL9838A00	5/38	1,25	AD1077	5/41	1,05	ED2324	5/36	0,23	ED3025	5/37	0,67
1SL9839A00	5/38	1,43	AD1080	5/43	-	ED2332	5/36	0,25	ED3033	5/37	0,09
1SL9840A00	5/38	1,80	AD1081	5/43	-	ED2340	5/36	0,22	ED3041	5/37	0,07
1SL9841A00	5/38	2,44	AD1083	5/43	0,25	ED2357	5/36	0,20	ED3058	5/37	0,06
1SL9842A00	5/38	2,85	AD1086	3/40	3,51	ED2365	5/36	0,27	ED3066	5/37	0,08
1SL9860A00	5/38	1,09	AD1086	3/41	3,51	ED2373	5/36	0,09	ED3082	5/37	0,25
1SL9861A00	5/38	1,13	AD1101	3/41	-	ED2381	5/36	0,26	ED3090	5/37	0,56
1SL9862A00	5/38	1,31	AD1102	3/41	-	ED2399	5/36	0,23	ED3101	5/37	0,30
1SL9863A00	5/38	1,49	AD1103	3/41	-	ED2407	5/36	0,26	ED3102	5/37	0,30
1SL9864A00	5/38	1,86	AD1104	3/41	-	ED2531	5/35	0,08	ED3103	5/37	0,30
1SL9865A00	5/38	2,50	AD1600	3/41	0,24	ED2549	5/35	0,08	ED3104	5/37	0,30
1SL9866A00	5/38	2,91	AD1800	3/41	0,36	ED2550	5/35	0,07	ED3108	5/37	0,05
1SL9880A00	5/39	0,14	AD3301	3/41	0,15	ED2551	5/35	0,13	ED3116	5/37	0,05
1SL9886A00	5/39	0,11	AD3302	3/41	0,15	ED2552	5/35	0,13	ED3124	5/37	0,08
1SL9887A00	5/39	0,14	AD3303	3/41	0,15	ED2553	5/35	0,13	ED3132	5/37	0,33
1SL9893A00	5/39	0,01	AD3304	3/41	0,15	ED2554	5/35	0,13	ED3272	5/37	0,10
1SL9904A00	5/38	0,31	AD3305	3/41	0,15	ED2556	5/35	0,08	ED3280	5/37	0,10
1SL9907A00	5/39	0,15	AD3306	3/41	0,15	ED2557	5/35	0,10	ED3298	5/37	0,10
1SL9910A00	5/39	0,23	AD3307	3/41	0,15	ED2558	5/35	0,10	ED3355	5/37	0,07
1SL9911A00	5/39	0,30	AD3308	3/41	0,15	ED2559	5/35	0,10	ED3363	5/37	0,08
1SL9912A00	5/39	0,38	AP6000	3/40	0,01	ED2560	5/35	0,10	ED3371	5/37	0,10
1SL9913A00	5/39	0,53	BF1602	5/42	2,70	ED2564	5/35	0,08	ED3405	5/37	0,59
1SL9914A00	5/39	0,68	BF2502	5/42	4,20	ED2572	5/35	0,08	ED3413	5/37	0,80
1SL9915A00	5/39	0,83	BF4002	5/42	3,00	ED2590	5/35	0,08	ED3439	5/37	1,30
AA1560	2/36	0,02	BF4012	5/42	6,50	ED2598	5/35	0,09	EV0036	3/40	0,20
AA1570	2/36	0,03	BF6302	5/42	12,50	ED2606	5/35	0,09	EV0037	3/40	0,35
AA6200	2/36	0,02	BF8002	5/42	19,10	ED2654	5/35	0,06	EV0042	3/40	0,25
AA8004	2/36	0,01	BS3250	5/42	1,60	ED2662	5/35	0,06	EV0103	2/37	0,50
AD1004	5/43	0,55	BS5050	5/42	1,80	ED2670	5/35	0,08	EV0104	2/37	0,50
AD1006	5/43	0,55	BS6350	5/42	2,25	ED2720	5/35	0,09	EV0114	2/34	0,95
AD1007	5/43	0,25	ED0001	5/36	0,22	ED2738	5/35	0,09	EV0116	2/34	0,95
AD1009	3/40	0,09	ED0002	5/36	0,28	ED2746	5/35	0,10	EV0117	2/35	0,75
AD1027	5/43	0,69	ED0003	5/36	0,29	ED2753	5/35	0,09	EV0119	2/35	0,20

Code	Page	Weight KG	Code	Page	Weight KG	Code	Page	Weight KG	Code	Page	Weight KG
EV0121	2/35	0,20	PBFA1201	5/30	7,66	PBPX2631	5/31	-	PBWP2570	4/13	2,96
EV0123	2/35	0,20	PBFA2005	5/30	0,74	PBPX2738	5/32	-	PBWP2590	4/13	-
EV0124	2/35	0,20	PBFA2505	5/30	0,85	PBPX3631	5/31	-	PBWP3020	2/26	1,31
EV0125	2/35	0,13	PBFA3005	5/30	1,02	PBPX3738	5/32	-	PBWP3030	2/26	1,79
EV0126	2/35	0,13	PBFA4005	5/30	1,33	PBPX4631	5/31	-	PBWP3050	2/26	2,66
EV0127	2/35	0,13	PBFA4010	5/30	2,52	PBPX4738	5/32	-	PBWP3050	4/13	2,66
EV1008	2/36	0,04	PBFA5005	5/30	1,74	PBRB0004	2/19	0,56	PBWP3070	2/26	3,43
EV1036	2/36	0,04	PBFA5010	5/30	3,20	PBRLO002	2/37	1,49	PBWP3090	2/26	4,44
EV1037	2/36	0,04	PBFA6005	5/30	2,13	PBRP1040	3/39	0,59	PBWP4020	2/26	1,64
EV1039	2/36	0,04	PBFA7510	5/30	4,88	PBRP2040	3/39	1,06	PBWP4030	2/26	2,15
EV1050	5/40	6,88	PBFA8005	5/30	2,73	PBRP3040	3/39	1,48	PBWP4050	2/26	3,27
EV1051	5/40	1,00	PBFA8010	5/30	5,08	PBRP6040	3/39	2,78	PBWP4070	2/26	4,57
EV1056	5/40	0,33	PBFC0160	5/42	2,66	PBSC0400	5/30	2,59	PBWP4090	2/26	5,36
EV1058	5/40	0,58	PBFC1001	5/29	15,50	PBSC0630	5/30	3,28	PBWP5020	4/13	-
EV1075K	2/36	0,20	PBFC1005	5/29	7,26	PBSC0800	5/30	4,81	PBWP5050	4/13	3,79
EV1090	5/40	0,46	PBFC1201	5/29	19,00	PBSC1000	5/30	-	PBWP5070	4/13	5,06
EV1091	5/40	0,88	PBFC1601	5/29	25,00	PBSC1250	5/30	-	PBWP5090	4/13	-
EV1092	5/40	0,55	PBFC2001	5/29	31,50	PBSC1600	5/30	11,97	PBWP6020	2/26	2,26
EV1093	5/40	0,55	PBFC2005	5/29	1,50	PBSC2000	5/30	-	PBWP6030	2/26	2,99
EV1100	2/37	1,15	PBFC2505	5/29	1,86	PBSC2500	5/30	-	PBWP6050	2/26	4,65
EV1101	2/37	1,28	PBFC3010	5/29	4,50	PBTT4631	5/31	-	PBWP6050	4/28	4,65
EV1110	3/40	2,74	PBFC3205	5/29	2,38	PBTT5631	5/31	-	PBWP6070	2/26	6,36
EV1110	5/41	2,74	PBFC4005	5/29	3,00	PBTT6631	5/31	-	PBWP6070	4/28	6,36
EV1111	3/40	0,68	PBFC4010	5/29	6,50	PBTT7631	5/31	-	PBWP6090	2/26	8,12
EV1112	3/40	2,74	PBFC5005	5/29	3,50	PBTX1631	5/31	-	PBWP6090	4/28	8,12
EV1113	5/41	0,13	PBFC5010	5/29	8,00	PBTX2631	5/31	-	PBWP7520	4/13	2,66
EV1119	5/40	3,60	PBFC6010	5/29	9,50	PBTX3631	5/31	-	PBWP7530	4/13	-
EV1120	5/40	4,50	PBFC6305	5/29	4,46	PBTX4631	5/31	-	PBWP7550	4/13	5,36
EV1121	5/40	8,85	PBFC8005	5/29	5,85	PBUF0002	5/35	-	PBWP7570	4/13	7,53
EV1122	5/40	2,44	PBFC8010	5/29	12,50	PBUF0002	5/37	-	PBWP7590	4/13	-
EV1123	5/40	2,49	PBGT4738	5/32	-	PBWF0002	2/37	0,09	PBWP8020	2/26	2,98
EV1124	5/40	2,77	PBGT5738	5/32	-	PBWP1030	2/26	4,80	PBWP8030	2/26	3,86
EV1125	5/40	2,77	PBGX1738	5/32	-	PBWP1030	4/13	4,80	PBWP8050	2/26	6,00
EV1135	3/41	0,24	PBGX2738	5/32	-	PBWP1050	2/26	7,30	PBWP8050	4/28	6,00
EV1136	3/41	0,16	PBGX3738	5/32	-	PBWP1050	4/13	7,30	PBWP8070	2/26	8,31
EV1137	3/41	0,24	PBGX4738	5/32	-	PBWP1050	4/28	7,30	PBWP8070	4/28	8,31
EV1150	5/43	0,10	PBHB1125	5/33	1,01	PBWP1070	2/26	9,60	PBWP8090	2/26	10,25
EV1151	5/43	0,10	PBHB2145	5/33	1,50	PBWP1070	4/13	9,60	PBWP8090	4/28	10,25
EV1152	5/43	0,10	PBHB3121	5/33	2,00	PBWP1070	4/28	9,60	PCBS1010	6/25	2,53
EV1153	5/43	0,10	PBHS1125	5/33	0,25	PBWP1090	2/26	12,12	PCBS1040	6/25	1,12
EV1154	5/43	0,10	PBMC0002	5/42	0,25	PBWP1090	4/13	12,12	PCBS1060	6/25	1,50
EV1155	5/43	0,01	PBMC0001	4/8	-	PBWP1230	4/13	-	PCBS1080	6/25	2,08
EV1156	5/43	0,07	PBMC0002	6/49	0,25	PBWP1250	4/13	-	PCBS1510	6/25	3,17
EV2110	3/40	0,56	PBPT4631	5/31	-	PBWP1270	4/13	-	PCBS1540	6/25	1,44
EV2112	3/40	0,56	PBPT4738	5/32	-	PBWP1290	2/26	9,03	PCBS1560	6/25	1,99
PBBH0004	5/33	0,46	PBPT5631	5/31	-	PBWP1290	4/13	9,03	PCBS1580	6/25	2,62
PBBT0008	5/33	0,79	PBPT5738	5/32	-	PBWP1290	4/13	9,03	PCBS2010	6/25	3,84
PBBV0008	5/33	0,87	PBPT6738	5/32	-	PBWP2520	4/13	-	PCBS2040	6/25	1,17
PBCB0002	5/33	-	PBPX1631	5/31	-	PBWP2530	4/13	-	PCBS2060	6/25	2,41
PBFA1001	5/30	6,47	PBPX1738	5/32	-	PBWP2550	4/13	2,18	PCBS2080	6/25	3,23

System pro E power

List of codes

Code	Page	Weight KG	Code	Page	Weight KG	Code	Page	Weight KG	Code	Page	Weight KG
PCBS2510	6/25	4,56	PCFS0200	2/15	-	PCRS0788	5/29	2,32	PCVS1358	6/47	2,11
PCBS2540	6/25	2,17	PCFS0300	2/15	2,50	PCRS0888	5/29	2,57	PCVS1404	6/47	1,64
PCBS2560	6/25	2,86	PCFS0400	2/15	3,00	PCRS0988	5/29	2,93	PCVS1406	6/47	1,94
PCBS2580	6/25	3,72	PCFS0600	2/15	4,00	PCRS1238	5/29	3,60	PCVS1408	6/47	2,29
PCBS3010	6/25	5,16	PCFS0700	2/15	5,00	PCSS0024	2/37	-	PCVS1504	6/47	1,95
PCBS3040	6/25	2,50	PCFS0800	2/15	6,00	PCSS0024	3/41	-	PCVS1506	6/47	2,30
PCBS3060	6/25	3,22	PCFS0900	2/15	6,00	PCTG1810	4/8	3,82	PCVS1508	6/47	2,68
PCBS3080	6/25	4,30	PCFS1000	2/15	7,00	PCTG1812	4/8	-	PCVS1604	6/47	2,27
PCBS5010	6/25	1,88	PCFS1250	2/15	8,00	PCTG1825	4/8	3,65	PCVS1606	6/47	2,64
PCBS5040	6/25	0,76	PCIS0500	6/32	0,88	PCTG1850	4/8	3,25	PCVS1608	6/47	3,07
PCBS5060	6/25	1,08	PCIS0500	4/18	0,88	PCTG1875	4/8	4,05	PCVS2204	6/48	1,27
PCBS5080	6/25	1,50	PCIS0700	6/32	1,26	PCTG2010	4/8	4,04	PCVS2206	6/48	1,59
PCCM0200	2/17	-	PCIS0900	6/32	1,49	PCTG2012	4/8	-	PCVS2208	6/48	1,87
PCCM0300	2/17	1,30	PCKI0250	4/18	-	PCTG2025	4/8	3,86	PCVS2254	6/48	1,49
PCCM0500	2/17	1,90	PCKI0300	5/34	1,35	PCTG2050	4/8	3,47	PCVS2256	6/48	1,80
PCCM0700	2/17	2,54	PCKI0400	5/34	1,53	PCTG2075	4/8	3,77	PCVS2258	6/48	2,11
PCCM0900	2/17	3,08	PCKI0600	5/34	2,04	PCTT6631	5/31	-	PCVS2304	6/48	1,69
PCCM2010	4/8	1,40	PCKI0750	4/18	-	PCTT7631	5/31	-	PCVS2306	6/48	2,02
PCCM2012	4/8	-	PCKI0800	5/34	2,82	PCVS0204	6/47	0,32	PCVS2308	6/48	2,35
PCCM2025	4/8	0,96	PCKI1000	5/34	3,32	PCVS0206	6/47	0,42	PCVS2354	6/48	1,90
PCCM2050	4/8	1,38	PCKI1000	4/18	3,32	PCVS0208	6/47	0,48	PCVS2356	6/48	2,25
PCCM2075	4/8	1,07	PCKI1250	5/34	4,05	PCVS0254	6/47	0,40	PCVS2358	6/48	2,60
PCCS0700	2/17	2,45	PCKI1250	4/18	4,05	PCVS0256	6/47	0,51	PCVS2404	6/48	2,05
PCCS0900	2/17	3,29	PCNL0050	4/24	-	PCVS0258	6/47	6,61	PCVS2406	6/48	2,45
PCFM0200	2/15	1,80	PCNL0100	4/24	-	PCVS0304	6/47	0,49	PCVS2408	6/48	2,82
PCFM0200	4/9	1,80	PCPA0004	2/18	1,00	PCVS0306	6/47	0,62	PCVS2504	6/48	2,41
PCFM0250	4/9	2,08	PCPT6738	5/32	-	PCVS0308	6/47	0,84	PCVS2506	6/48	2,85
PCFM0300	2/15	2,33	PCRM0188	5/28	0,44	PCVS0354	6/47	0,56	PCVS2508	6/48	3,26
PCFM0300	4/9	2,33	PCRM0188	5/28	0,44	PCVS0356	6/47	0,71	PCVS2604	6/48	2,85
PCFM0400	2/15	3,15	PCRM0238	5/28	0,57	PCVS0358	6/47	0,84	PCVS2606	6/48	3,31
PCFM0500	2/15	3,62	PCRM0288	5/28	0,69	PCVS0404	6/47	0,65	PCVS2608	6/48	3,79
PCFM0500	4/9	3,62	PCRM0338	5/28	0,81	PCVS0406	6/47	0,80	PCVS5060	6/48	3,93
PCFM0500	4/9	3,62	PCRM0388	5/28	0,92	PCVS0408	6/47	0,97	PCVS5080	6/48	-
PCFM0500	4/25	3,62	PCRM0438	5/28	1,04	PCVS0504	6/47	0,80	PDCB1820	2/33	5,00
PCFM0600	2/15	4,29	PCRM0488	5/28	1,17	PCVS0506	6/47	0,99	PDCB1820	6/44	5,00
PCFM0600	4/25	4,29	PCRM0538	5/28	1,30	PCVS0508	6/47	1,19	PDCB1830	2/33	8,00
PCFM0700	2/15	4,95	PCRM0588	5/28	1,40	PCVS0604	6/47	0,95	PDCB1830	6/44	8,00
PCFM0700	4/9	4,95	PCRM0638	5/28	1,55	PCVS0606	6/47	1,12	PDCB1840	2/33	9,00
PCFM0700	4/25	4,95	PCRM0688	5/28	1,63	PCVS0608	6/47	1,43	PDCB1840	6/44	9,00
PCFM0750	4/9	5,11	PCRM0738	5/28	1,75	PCVS1204	6/47	1,12	PDCB1844	2/33	10,50
PCFM0800	2/15	5,58	PCRM0788	5/28	1,88	PCVS1206	6/47	1,20	PDCB1844	6/44	10,50
PCFM0800	4/25	5,58	PCRM0888	5/28	2,14	PCVS1208	6/47	1,46	PDCB2020	2/33	5,64
PCFM0900	2/15	6,34	PCRM0988	5/28	2,35	PCVS1254	6/47	1,06	PDCB2020	6/44	5,64
PCFM0900	4/9	6,34	PCRM1238	5/28	2,99	PCVS1256	6/47	1,42	PDCB2030	2/33	9,00
PCFM0900	4/25	6,34	PCRM2013	5/28	5,00	PCVS1258	6/47	1,68	PDCB2030	6/44	9,00
PCFM1000	2/15	7,07	PCRS0338	5/29	0,97	PCVS1304	6/47	1,32	PDCB2040	2/33	10,00
PCFM1000	4/9	7,07	PCRS0388	5/29	1,14	PCVS1306	6/47	1,57	PDCB2040	6/44	10,00
PCFM1000	4/25	7,07	PCRS0438	5/29	1,28	PCVS1308	6/47	1,94	PDCB2044	2/33	11,50
PCFM1250	2/15	9,50	PCRS0588	5/29	1,70	PCVS1354	6/47	1,51	PDCB2044	6/44	11,50
PCFM1250	4/9	9,50	PCRS0638	5/29	1,85	PCVS1356	6/47	1,78	PDFC0200	4/8	-

Code	Page	Weight KG	Code	Page	Weight KG	Code	Page	Weight KG	Code	Page	Weight KG
PDFC0300	4/8	-	PDLB2066	2/31	25,00	PDLG2062	2/30	30,00	PFBS1020	6/44	-
PDFC0500	4/8	-	PDLB2066	4/32	25,00	PDLG2064	2/30	35,00	PFBS1040	6/44	-
PDFC0700	4/8	-	PDLB2075	4/18	31,00	PDLG2066	2/30	25,00	PFBS8020	6/44	-
PDFC0900	4/8	-	PDLB2076	4/17	31,50	PDLG2066	4/16	25,00	PFBS8040	6/44	-
PDGT4738	5/32	-	PDLB2080	2/31	32,50	PDLG2066	4/31	25,00	PFCB1016	5/34	0,66
PDGT5738	5/32	-	PDLB2080	4/33	32,50	PDLG2070	4/17	28,50	PFCB2025	5/34	0,89
PDGX1738	5/32	-	PDLB2086	2/31	32,50	PDLG2076	4/16	28,50	PFCB4080	5/34	0,34
PDGX2738	5/32	-	PDLB2086	4/32	32,50	PDLG2080	2/30	30,00	PFC00023	5/34	0,84
PDGX3738	5/32	-	PDLB2120	2/32	13,00	PDLG2080	4/32	30,00	PFCF1030	2/25	3,80
PDGX4738	5/32	-	PDLB2500	2/32	38,00	PDLG2082	2/30	35,00	PFCF1030	4/13	3,80
PDLB1810	2/31	34,00	PDLB8120	2/32	11,00	PDLG2086	2/30	30,00	PFCF1050	2/25	6,92
PDLB1810	4/18	34,00	PDLB8500	2/32	34,00	PDLG2086	4/31	30,00	PFCF1050	4/13	6,92
PDLB1810	4/33	34,00	PDLG1810	2/30	32,00	PDLG2420	2/30	25,00	PFCF1050	4/28	6,92
PDLB1816	2/31	34,50	PDLG1810	4/17	32,00	PDLG2440	2/30	30,00	PFCF1070	2/25	9,37
PDLB1816	4/17	34,50	PDLG1810	4/32	32,00	PDLG2500	2/32	35,00	PFCF1070	4/13	9,37
PDLB1816	4/32	34,50	PDLG1816	2/30	32,00	PDLG2620	2/30	30,00	PFCF1070	4/28	9,37
PDLB1825	4/18	12,86	PDLG1816	4/16	32,00	PDLG2640	2/30	36,00	PFCF1090	2/25	12,60
PDLB1826	4/17	13,00	PDLG1816	4/31	32,00	PDLG2820	2/30	35,00	PFCF1090	4/13	12,60
PDLB1830	2/31	14,00	PDLG1840	2/30	18,00	PDLG8420	2/30	23,00	PFCF1090	4/28	12,60
PDLB1836	2/31	14,50	PDLG1842	2/30	23,00	PDLG8440	2/30	27,50	PFCF2520	4/13	0,47
PDLB1840	2/31	16,50	PDLG1844	2/30	27,50	PDLG8500	2/32	32,00	PFCF2530	4/13	0,78
PDLB1846	2/31	17,00	PDLG1846	2/30	18,00	PDLG8620	2/30	27,00	PFCF2550	4/13	1,41
PDLB1850	4/18	22,00	PDLG1850	4/17	20,00	PDLG8640	2/30	31,50	PFCF2570	4/13	2,02
PDLB1856	4/17	21,50	PDLG1856	4/16	20,00	PDLG8820	2/30	32,00	PFCF2590	4/13	2,61
PDLB1860	2/31	24,00	PDLG1860	2/30	23,00	PDPT4631	5/31	-	PFCF3020	2/25	0,56
PDLB1860	4/33	24,00	PDLG1860	4/32	23,00	PDPT4738	5/32	-	PFCF3030	2/25	1,00
PDLB1866	2/31	24,50	PDLG1862	2/30	27,50	PDPT5631	5/31	-	PFCF3050	2/25	1,50
PDLB1866	4/32	24,50	PDLG1864	2/30	32,00	PDPT5738	5/32	-	PFCF3050	4/13	1,50
PDLB1875	4/18	29,00	PDLG1866	2/30	23,00	PDPT6738	5/32	-	PFCF3070	2/25	2,50
PDLB1876	4/17	29,00	PDLG1866	4/31	23,00	PDPX1631	5/31	-	PFCF3090	2/25	3,00
PDLB1880	2/31	29,00	PDLG1870	4/17	26,00	PDPX1738	5/32	-	PFCF4020	2/25	0,80
PDLB1880	4/33	29,00	PDLG1876	4/16	26,50	PDPX2631	5/31	-	PFCF4030	2/25	1,31
PDLB1886	2/31	29,50	PDLG1880	2/30	27,50	PDPX2738	5/32	-	PFCF4050	2/25	2,50
PDLB1886	4/32	29,50	PDLG1880	4/32	27,50	PDPX3631	5/31	-	PFCF4070	2/25	3,50
PDLB2010	2/31	38,00	PDLG1882	2/30	32,00	PDPX3738	5/32	-	PFCF4090	2/25	5,00
PDLB2010	4/18	38,00	PDLG1886	2/30	27,50	PDPX4631	5/31	-	PFCF5020	4/13	1,00
PDLB2010	4/33	38,00	PDLG1886	4/31	27,50	PDPX4738	5/32	-	PFCF5050	4/13	3,13
PDLB2016	2/31	38,50	PDLG2010	2/30	35,00	PDRS0400	3/22	1,13	PFCF5070	4/13	4,72
PDLB2016	4/17	38,50	PDLG2010	4/17	35,00	PDRS0400	3/39	1,13	PFCF5090	4/13	5,93
PDLB2016	4/32	38,50	PDLG2010	4/32	35,00	PDRS0600	3/22	1,40	PFCF6020	2/25	1,28
PDLB2025	4/18	14,00	PDLG2016	2/30	38,50	PDRS0800	3/22	1,45	PFCF6030	2/25	2,00
PDLB2026	4/17	14,00	PDLG2016	4/31	38,50	PDTT4631	5/31	-	PFCF6050	2/25	3,50
PDLB2030	2/31	15,50	PDLG2040	2/30	19,50	PDTT5631	5/31	-	PFCF6050	4/28	3,50
PDLB2036	2/31	15,50	PDLG2042	2/30	25,00	PDTT6631	5/31	-	PFCF6070	2/25	5,50
PDLB2040	2/31	18,00	PDLG2044	2/30	30,00	PDTT7631	5/31	-	PFCF6070	4/28	5,50
PDLB2046	2/31	18,50	PDLG2046	2/30	20,00	PDTX1631	5/31	-	PFCF6090	2/25	7,50
PDLB2050	4/18	24,00	PDLG2050	4/17	22,00	PDTX2631	5/31	-	PFCF6090	4/13	7,50
PDLB2056	4/17	24,00	PDLG2056	4/16	22,50	PDTX3631	5/31	-	PFCF6090	4/28	7,50
PDLB2060	2/31	26,50	PDLG2060	2/30	25,00	PDTX4631	5/31	-	PFCF7520	4/13	1,60
PDLB2060	4/33	26,50	PDLG2060	4/32	25,00	PEBL0004	2/37	0,67	PFCF7530	4/13	1,67

System pro E power

List of codes

Code	Page	Weight KG	Code	Page	Weight KG	Code	Page	Weight KG	Code	Page	Weight KG
PFCF7550	4/13	4,96	PFPF1840	3/20	7,03	PFVS3242	6/31	1,81	PHBX2427	3/23	3,19
PFCF7570	4/13	7,13	PFPF1860	3/20	7,47	PFVS3243	6/31	1,74	PHBX2428	3/23	3,44
PFCF7590	4/13	9,00	PFPF1880	3/20	8,04	PFVS8030	6/44	-	PHBX2431	3/23	5,68
PFCF8020	2/25	1,50	PFPF2010	3/20	9,23	PGPP0040	2/29	0,19	PHBX3301	3/23	2,02
PFCF8030	2/25	3,00	PFPF2012	3/20	9,80	PGPP0040	4/16	0,19	PHBX3305	3/23	2,04
PFCF8050	2/25	5,00	PFPF2040	3/20	7,70	PGPP0040	4/31	0,19	PHBX3401	3/23	3,18
PFCF8050	4/28	5,00	PFPF2060	3/20	7,80	PHBT4301	3/24	1,93	PHBX3404	3/23	3,18
PFCF8070	2/25	7,50	PFPF2080	3/20	8,68	PHBT4402	3/24	5,62	PHBX3405	3/23	3,20
PFCF8070	4/28	7,50	PFPS1840	3/20	15,00	PHBT4404	3/24	3,63	PHBX3407	3/23	3,16
PFCF8090	2/25	10,00	PFPS1860	3/20	17,00	PHBT4406	3/24	3,12	PHBX3409	3/23	3,44
PFCF8090	4/28	10,00	PFPS1880	3/20	18,00	PHBT5304	3/24	3,48	PHBX3422	3/23	5,01
PFCS1050	2/25	4,74	PFPS2040	3/20	16,02	PHBT5306	3/24	3,11	PHBX3423	3/23	3,75
PFCS1050	4/14	4,74	PFPS2060	3/20	18,00	PHBT5309	3/24	6,95	PHBX3424	3/23	6,31
PFCS1050	4/29	4,74	PFPS2080	3/20	20,00	PHBT5312	3/24	5,32	PHBX3427	3/23	3,19
PFCS1070	2/25	6,83	PFPT6738	5/32	-	PHBT5314	3/24	4,01	PHBX4301	3/23	2,82
PFCS1070	4/14	6,83	PFRF1840	3/39	-	PHBT5326	3/24	3,10	PHBX4400	3/24	3,58
PFCS1070	4/29	6,83	PFRF2040	3/39	5,92	PHBT5404	3/24	3,98	PHBX4401	3/23	3,06
PFCS1090	2/25	9,37	PFTT6631	5/31	-	PHBT5406	3/24	3,55	PHBX4402	3/24	4,93
PFCS1090	4/14	9,37	PFTT7631	5/31	-	PHBT5409	3/24	4,74	PHBX4404	3/23	3,12
PFCS1090	4/29	9,37	PFVS1030	6/44	-	PHBT5412	3/24	5,84	PHBX4405	3/23	3,19
PFCS4050	2/25	1,67	PFVS1040	6/44	-	PHBT5414	3/24	4,46	PHBX4407	3/23	3,05
PFCS4070	2/25	2,40	PFVS1040	6/44	-	PHBT5426	3/24	6,64	PHBX4409	3/23	3,47
PFCS4090	2/25	3,14	PFVS2012	6/30	2,71	PHBX1101	3/22	3,19	PHBX4410	3/24	3,49
PFCS5050	4/14	-	PFVS2040	6/28	1,22	PHBX1105	3/22	3,18	PHBX4412	3/24	3,94
PFCS5070	4/14	-	PFVS2042	6/23	1,10	PHBX1323	3/22	3,28	PHBX4423	3/24	3,01
PFCS5090	4/14	-	PFVS2042	6/30	1,10	PHBX1401	3/22	1,92	PHBX4424	3/24	6,28
PFCS6050	2/25	2,71	PFVS2060	6/28	1,68	PHBX1404	3/22	3,23	PHBX4425	3/24	6,38
PFCS6050	4/29	2,71	PFVS2062	6/23	1,54	PHBX1405	3/22	2,01	PHBX4427	3/23	3,11
PFCS6070	2/25	3,85	PFVS2062	6/30	1,54	PHBX1407	3/22	3,30	PHBX4428	3/23	-
PFCS6070	4/29	3,85	PFVS2080	6/28	2,17	PHBX1409	3/22	3,51	PHBX4431	3/24	5,44
PFCS6090	2/25	5,09	PFVS2082	6/23	2,63	PHBX1422	3/22	4,93	PHCE1240	3/29	10,60
PFCS6090	4/14	5,09	PFVS2082	6/30	2,63	PHBX1423	3/22	3,30	PHCE1241	3/29	6,27
PFCS6090	4/29	5,09	PFVS2122	6/30	3,28	PHBX1424	3/22	6,29	PHCT4301	3/26	2,75
PFCS7550	4/14	-	PFVS2130	6/29	1,07	PHBX1427	3/22	3,29	PHCT4402	3/26	8,61
PFCS7570	4/14	-	PFVS2132	6/30	0,97	PHBX2300	3/23	3,17	PHCT4403	3/26	10,26
PFCS7590	4/14	-	PFVS2140	6/29	1,32	PHBX2301	3/22	2,02	PHCT4404	3/26	4,59
PFCS8050	2/25	3,64	PFVS2220	6/29	0,46	PHBX2310	3/22	3,17	PHCT4406	3/26	4,28
PFCS8050	4/29	3,64	PFVS2222	6/31	0,94	PHBX2312	3/22	3,49	PHCT4423	3/26	4,13
PFCS8070	2/25	6,01	PFVS2223	6/31	0,71	PHBX2400	3/23	3,61	PHCT5304	3/26	4,62
PFCS8070	4/29	6,01	PFVS2240	6/29	1,02	PHBX2401	3/23	3,20	PHCT5306	3/26	4,16
PFCS8090	2/25	7,28	PFVS2242	6/31	1,36	PHBX2402	3/23	4,97	PHCT5307	3/32	-
PFCS8090	4/29	7,28	PFVS2243	6/31	1,19	PHBX2404	3/23	4,23	PHCT5309	3/26	5,61
PFNL1810	4/24	-	PFVS3012	6/30	3,78	PHBX2405	3/23	3,09	PHCT5310	3/32	-
PFNL1860	4/24	-	PFVS3042	6/30	1,61	PHBX2407	3/23	3,14	PHCT5312	3/26	7,22
PFNL1880	4/24	7,20	PFVS3062	6/30	2,31	PHBX2409	3/23	3,46	PHCT5314	3/26	5,51
PFNL2010	4/24	8,20	PFVS3082	6/30	3,02	PHBX2410	3/23	3,62	PHCT5314	3/27	5,51
PFNL2060	4/24	-	PFVS3122	6/30	4,68	PHBX2412	3/23	3,95	PHCT5326	3/26	4,21
PFNL2080	4/24	7,40	PFVS3132	6/30	1,26	PHBX2423	3/23	3,18	PHCT5402	3/27	8,79
PFPF1810	3/20	8,00	PFVS3222	6/31	0,70	PHBX2424	3/23	6,35	PHCT5403	3/27	10,37
PFPF1812	3/20	9,24	PFVS3223	6/31	1,00	PHBX2425	3/23	6,29	PHCT5404	3/27	3,31

Code	Page	Weight KG	Code	Page	Weight KG	Code	Page	Weight KG	Code	Page	Weight KG
PHCT5406	3/27	4,69	PHCX2407	3/25	4,23	PHDT5409	3/28	8,15	PKNL1210	4/24	13,60
PHCT5409	3/27	6,33	PHCX2409	3/25	3,89	PHDT5411	3/28	15,60	PKNL1260	4/24	9,00
PHCT5411	3/27	11,46	PHCX2410	3/25	4,98	PHDT5412	3/28	10,08	PKNL1280	4/24	10,40
PHCT5412	3/27	7,90	PHCX2412	3/25	5,33	PHDT5414	3/28	7,91	PKOH1060	3/35	11,85
PHCT5414	3/27	6,10	PHCX2417	3/25	4,80	PHDT5423	3/28	6,21	PKOH1080	3/35	13,62
PHCT5423	3/27	4,90	PHCX2423	3/25	3,74	PHDT5425	3/28	14,76	PKOH1660	3/35	5,00
PHCT5425	3/27	11,50	PHCX2424	3/25	9,06	PHDT5426	3/28	6,08	PKOH1680	3/35	6,31
PHCT5426	3/27	4,79	PHCX2425	3/25	8,95	PHDT6301	3/28	7,64	PKOH3160	3/35	5,64
PHCT5431	3/27	9,37	PHCX2427	3/25	4,30	PHDT6304	3/28	7,55	PKOH3180	3/35	7,17
PHCT5432	3/27	12,42	PHCX2431	3/25	8,34	PHDT6305	3/28	7,52	PKOH6360	3/35	8,38
PHCT6301	3/27	5,46	PHCX3301	3/25	2,86	PHDT6312	3/28	9,77	PKOH6380	3/35	10,71
PHCT6304	3/27	5,89	PHCX3305	3/25	2,84	PHDT6314	3/28	7,64	PKOV1060	3/35	12,01
PHCT6305	3/27	5,40	PHCX3401	3/25	4,24	PHDT6401	3/28	7,70	PKOV1080	3/35	13,89
PHCT6312	3/27	7,58	PHCX3404	3/25	4,19	PHDT6404	3/28	8,31	PKOV1660	3/35	6,31
PHCT6314	3/27	5,81	PHCX3405	3/26	4,22	PHDT6405	3/29	7,53	PKOV1680	3/35	8,24
PHCT6400	3/27	7,88	PHCX3407	3/26	4,30	PHDT6412	3/29	12,58	PKOV3160	3/35	7,68
PHCT6401	3/27	6,07	PHCX3409	3/26	4,58	PHDT6414	3/29	9,46	PKOV3180	3/35	9,94
PHCT6402	3/27	9,24	PHCX3422	3/26	7,61	PHDT7329	3/29	7,04	PKOV6360	3/35	8,32
PHCT6403	3/27	11,23	PHCX3423	3/26	4,90	PHDT7418	3/29	8,87	PKOV6380	3/35	10,76
PHCT6404	3/27	6,44	PHCX3424	3/26	9,04	PHDT7420	3/29	7,51	PKPT1020	2/23	4,50
PHCT6405	3/27	6,07	PHCX3427	3/26	4,25	PHDT7430	3/29	14,40	PKPT1020	4/12	4,50
PHCT6410	3/27	7,96	PHCX4301	3/26	2,79	PHDX1423	3/28	-	PKPT1030	2/23	6,00
PHCT6411	3/27	12,44	PHCX4400	3/26	4,79	PHDX2401	3/28	5,38	PKPT1030	4/12	6,00
PHCT6412	3/27	10,14	PHCX4401	3/26	4,08	PHDX2404	3/28	5,31	PKPT1050	2/23	7,50
PHCT6425	3/27	11,60	PHCX4402	3/26	7,33	PHDX2423	3/28	5,26	PKPT1050	4/12	7,50
PHCT7329	3/27	5,42	PHCX4404	3/26	4,24	PHDX2428	3/28	-	PKPT1050	4/27	7,50
PHCT7418	3/27	6,79	PHCX4405	3/26	4,31	PHDX3423	3/28	-	PKPT1070	2/23	12,00
PHCT7420	3/27	5,99	PHCX4407	3/26	4,14	PHDX4401	3/28	5,29	PKPT1070	4/12	12,00
PHCT7430	3/27	11,19	PHCX4409	3/26	4,62	PHDX4404	3/28	5,29	PKPT1070	4/27	12,00
PHCX1101	3/25	4,32	PHCX4410	3/26	4,87	PHDX4423	3/28	5,19	PKPT1090	2/23	14,00
PHCX1105	3/25	4,30	PHCX4412	3/26	5,40	PHDX4428	3/28	-	PKPT1090	4/12	14,00
PHCX1323	3/25	4,39	PHCX4417	3/26	4,65	PHFP0020	3/41	0,80	PKPT1090	4/27	14,00
PHCX1401	3/25	2,85	PHCX4423	3/26	4,16	PHFR4180	2/37	-	PKPT1220	2/23	-
PHCX1404	3/25	4,31	PHCX4424	3/26	9,12	PHELL0020	2/36	0,25	PKPT1230	4/12	-
PHCX1405	3/25	2,84	PHCX4425	3/26	8,97	PHLS0010	2/36	0,24	PKPT1250	4/12	-
PHCX1407	3/25	4,28	PHCX4427	3/26	4,25	PIDH0010	2/36	0,30	PKPT1259	2/23	17,00
PHCX1409	3/25	4,60	PHCX4431	3/26	7,97	PIEH0008	2/36	0,02	PKPT1259	4/12	17,00
PHCX1422	3/25	7,43	PHDE1240	3/29	12,47	PIFH0020	2/36	0,02	PKPT1270	4/12	-
PHCX1423	3/25	4,28	PHDE1241	3/29	8,47	PIRH0405	2/36	-	PKPT2520	4/12	-
PHCX1424	3/25	9,25	PHDR0004	2/37	0,19	PIRH0455	2/36	-	PKPT2530	4/12	-
PHCX1427	3/25	4,23	PHDT4402	3/28	11,48	PIRH1242	2/36	-	PKPT2550	4/12	3,00
PHCX2300	3/25	4,39	PHDT4403	3/28	11,68	PIRP2040	3/39	0,94	PKPT2570	4/12	3,70
PHCX2301	3/25	2,82	PHDT5304	3/28	5,82	PISH0007	2/36	0,02	PKPT2590	4/12	-
PHCX2310	3/25	4,26	PHDT5306	3/28	5,30	PIE7120	5/32	-	PKPT3020	2/23	2,00
PHCX2312	3/25	4,67	PHDT5309	3/28	6,92	PITH0064	2/36	0,02	PKPT3030	2/23	2,50
PHCX2400	3/25	4,90	PHDT5312	3/28	9,11	PITH1234	5/32	-	PKPT3050	2/23	3,50
PHCX2401	3/25	3,88	PHDT5314	3/28	7,04	PITH5000	5/32	-	PKPT3070	2/23	4,50
PHCX2402	3/25	7,36	PHDT5326	3/28	5,35	PITH6000	5/32	-	PKPT3090	2/23	5,50
PHCX2404	3/25	4,26	PHDT5404	3/28	6,74	PITV6000	5/32	-	PKPT4020	2/23	2,00
PHCX2405	3/25	4,34	PHDT5406	3/28	6,27	PKEK0004	3/21	0,44	PKPT4030	2/23	3,00
									PKPT4050	2/23	4,00

System pro E power

List of codes

Code	Page	Weight KG	Code	Page	Weight KG	Code	Page	Weight KG	Code	Page	Weight KG
PKPT4070	2/23	5,00	PLVS3092	6/35	2,48	PMCS3050	5/42	2,26	PPEA1890	2/29	15,00
PKPT4090	2/23	6,50	PLVS3092	6/41	2,48	PMCS3050	6/49	2,26	PPEA1890	4/16	15,00
PKPT5020	4/12	-	PLVS3552	6/35	1,18	PMCS3070	5/42	3,71	PPEA1890	4/31	15,00
PKPT5030	4/12	-	PLVS3552	6/41	1,18	PMCS3070	6/49	3,71	PPEA2010	2/28	17,50
PKPT5050	4/12	5,00	PLVS3572	6/35	1,95	PMCS3090	5/42	-	PPEA2010	4/30	17,50
PKPT5070	4/12	6,00	PLVS3572	6/41	1,95	PMCS3090	6/49	-	PPEA2030	2/28	7,00
PKPT5090	4/12	-	PLVS3592	6/35	2,78	PMRP2040	3/39	0,86	PPEA2030	2/29	7,00
PKPT6020	2/23	3,00	PLVS3592	6/41	2,78	PPAM0100	2/18	3,70	PPEA2030	4/16	7,00
PKPT6030	2/23	4,00	PLVS4052	6/35	1,35	PPAM0100	4/26	3,70	PPEA2040	2/28	9,00
PKPT6050	2/23	5,50	PLVS4072	6/35	2,25	PPAM0200	2/18	7,35	PPEA2050	2/29	11,00
PKPT6050	4/27	5,50	PLVS4092	6/35	3,33	PPAM0200	4/26	7,35	PPEA2050	4/16	11,00
PKPT6070	2/23	7,50	PLVS5052	6/35	1,75	PPBR2040	3/38	1,11	PPEA2050	4/31	11,00
PKPT6070	4/27	7,50	PLVS5072	6/35	2,84	PPBR2060	3/38	1,61	PPEA2060	2/28	12,00
PKPT6090	2/23	9,00	PLVS5092	6/35	4,13	PPBR2080	3/38	2,14	PPEA2060	4/30	12,00
PKPT6090	4/27	9,00	PLVS6052	6/35	2,10	PPBR4040	3/38	1,95	PPEA2070	2/29	14,00
PKPT7520	4/12	-	PLVS6072	6/35	3,44	PPBR4060	3/38	2,88	PPEA2070	4/16	14,00
PKPT7530	4/12	-	PLVS6092	6/35	4,94	PPBR4080	3/38	3,98	PPEA2070	4/31	14,00
PKPT7550	4/12	7,00	PLVS7052	6/27	2,43	PPBR6040	3/38	2,81	PPEA2075	4/15	14,50
PKPT7570	4/12	9,00	PLVS7052	6/42	2,43	PPBR6060	3/38	4,19	PPEA2080	2/28	15,00
PKPT7590	4/12	-	PLVS7052	6/45	2,43	PPBR6080	3/38	5,25	PPEA2080	4/30	15,00
PKPT8020	2/23	4,00	PLVS7072	6/27	4,12	PPBS0050	6/32	0,09	PPEA2090	2/29	16,50
PKPT8030	2/23	5,00	PLVS7072	6/42	4,12	PPBS0100	6/32	0,19	PPEA2090	4/16	16,50
PKPT8050	2/23	9,50	PLVS7072	6/45	4,12	PPBS0150	6/32	0,28	PPEA2090	4/31	16,50
PKPT8050	4/27	9,50	PLVS7092	6/27	5,78	PPBS0200	6/32	0,37	PPEB1810	4/14	18,00
PKPT8070	2/23	7,00	PLVS7092	6/42	5,78	PPBS0250	6/32	0,49	PPEB1810	4/29	18,00
PKPT8070	4/27	7,00	PLVS7092	6/45	5,78	PPBS0300	6/32	0,55	PPEB1816	2/27	30,00
PKPT8090	2/23	11,00	PMCS1755	5/42	1,36	PPCV1800	2/32	1,88	PPEB1816	4/14	30,00
PKPT8090	4/27	11,00	PMCS1755	6/49	1,36	PPCV1800	4/18	1,88	PPEB1816	4/29	30,00
PLVS1752	6/41	0,58	PMCS1757	5/42	-	PPCV1800	4/33	1,88	PPEB1820	2/29	5,50
PLVS1772	6/41	0,97	PMCS1757	6/49	-	PPCV2000	2/32	1,94	PPEB1820	4/15	5,50
PLVS1792	6/41	1,40	PMCS1759	5/42	3,29	PPCV2000	4/18	1,94	PPEB1825	4/14	9,50
PLVS2052	6/35	0,66	PMCS1759	6/49	3,29	PPCV2000	4/33	1,94	PPEB1826	2/28	8,50
PLVS2052	6/41	0,66	PMCS2050	5/42	1,53	PPDS0200	6/23	0,74	PPEB1826	4/15	8,50
PLVS2072	6/35	1,11	PMCS2050	6/49	1,53	PPEA1810	2/28	15,50	PPEB1827	4/14	6,50
PLVS2072	6/41	1,11	PMCS2070	5/42	2,55	PPEA1810	4/30	15,50	PPEB1830	2/29	7,00
PLVS2092	6/35	1,64	PMCS2070	6/49	2,55	PPEA1830	2/28	6,50	PPEB1830	4/15	7,00
PLVS2092	6/41	1,64	PMCS2090	5/42	3,62	PPEA1830	2/29	6,50	PPEB1836	2/27	11,00
PLVS2252	6/41	0,74	PMCS2090	6/49	3,62	PPEA1830	4/16	6,50	PPEB1836	2/28	11,00
PLVS2272	6/41	1,24	PMCS2255	5/42	-	PPEA1840	2/28	8,00	PPEB1836	4/15	11,00
PLVS2292	6/41	1,76	PMCS2255	6/49	-	PPEA1850	2/29	10,00	PPEB1846	2/27	14,00
PLVS2552	6/35	0,83	PMCS2257	5/42	-	PPEA1850	4/16	10,00	PPEB1850	2/29	10,00
PLVS2552	6/41	0,83	PMCS2257	6/49	-	PPEA1850	4/31	10,00	PPEB1850	4/14	10,00
PLVS2572	6/35	1,40	PMCS2259	5/42	3,95	PPEA1860	2/28	11,00	PPEB1850	4/15	10,00
PLVS2572	6/41	1,40	PMCS2259	6/49	3,95	PPEA1860	4/30	11,00	PPEB1850	4/30	10,00
PLVS2592	6/35	2,11	PMCS2550	5/42	1,89	PPEA1870	2/29	12,50	PPEB1856	2/28	16,00
PLVS2592	6/41	2,11	PMCS2550	6/49	1,89	PPEA1870	4/16	12,50	PPEB1856	4/14	16,00
PLVS3052	6/35	1,00	PMCS2570	5/42	-	PPEA1870	4/31	12,50	PPEB1856	4/15	16,00
PLVS3052	6/41	1,00	PMCS2570	6/49	-	PPEA1875	4/15	13,50	PPEB1856	4/30	16,00
PLVS3072	6/35	1,68	PMCS2590	5/42	4,34	PPEA1880	2/28	13,00	PPEB1860	4/29	12,00
PLVS3072	6/41	1,68	PMCS2590	6/49	4,34	PPEA1880	4/30	13,00	PPEB1866	2/27	19,00

Code	Page	Weight KG	Code	Page	Weight KG	Code	Page	Weight KG	Code	Page	Weight KG
PPEB1866	4/29	19,00	PPEB2076	2/28	23,50	PPFB8040	3/37	3,31	PPFV1800	4/18	4,50
PPEB1870	2/29	13,50	PPEB2076	4/15	23,50	PPFB8060	3/37	4,98	PPFV1800	4/33	4,50
PPEB1870	4/15	13,50	PPEB2076	4/30	23,50	PPFH0250	4/18	-	PPFV2000	2/32	4,42
PPEB1870	4/30	13,50	PPEB2077	4/14	15,50	PPFH0300	2/32	1,37	PPFV2000	4/18	4,42
PPEB1875	4/14	22,50	PPEB2080	4/29	16,50	PPFH0400	2/32	1,58	PPFV2000	4/33	4,42
PPEB1876	2/28	21,50	PPEB2086	2/27	25,40	PPFH0500	4/18	-	PPIM0100	2/18	3,09
PPEB1876	4/15	21,50	PPEB2086	4/29	25,40	PPFH0600	2/32	1,99	PPIM0200	2/18	6,45
PPEB1876	4/30	21,50	PPEB2090	2/29	18,00	PPFH0600	4/33	1,99	PPLA1820	2/28	10,50
PPEB1877	4/14	14,00	PPEB2090	4/15	18,00	PPFH0750	4/18	-	PPLA1820	4/15	10,50
PPEB1880	4/29	15,00	PPEB2090	4/30	18,00	PPFH0800	2/32	2,40	PPLA2020	2/28	12,00
PPEB1886	2/27	24,50	PPEB2096	2/28	28,00	PPFH0800	4/33	2,40	PPLA2020	4/15	12,00
PPEB1886	4/29	24,50	PPEB2096	4/15	28,00	PPFH1000	2/32	2,78	PPLB1820	4/14	11,50
PPEB1890	2/29	16,50	PPEB2096	4/30	28,00	PPFH1000	4/18	2,78	PPLB2020	4/14	13,00
PPEB1890	4/15	16,50	PPFA1010	3/38	1,16	PPFH1000	4/33	2,78	PPMB1540	3/36	0,63
PPEB1890	4/30	16,50	PPFA1040	3/38	0,46	PPFH1250	2/32	3,32	PPMB1560	3/36	1,81
PPEB1896	2/28	26,50	PPFA1060	3/38	0,69	PPFH1250	4/18	3,32	PPMB1580	3/36	2,26
PPEB1896	4/15	26,50	PPFA1080	3/38	0,88	PPFI2726	3/38	1,34	PPMB2010	3/36	4,32
PPEB1896	4/30	26,50	PPFA2010	3/38	2,02	PPFI2728	3/38	1,78	PPMB2012	3/36	-
PPEB2010	4/14	20,00	PPFA2040	3/38	0,87	PPFI2966	3/38	1,26	PPMB2040	3/36	2,56
PPEB2010	4/29	20,00	PPFA2060	3/38	1,22	PPFI2968	3/38	1,70	PPMB2060	3/36	3,06
PPEB2016	2/27	32,00	PPFA2080	3/38	1,61	PPFI4726	3/38	1,23	PPMB2080	3/36	3,83
PPEB2016	4/14	32,00	PPFB1040	3/37	0,50	PPFI4728	3/38	1,67	PPMB2512	3/36	-
PPEB2016	4/29	32,00	PPFB1060	3/37	0,72	PPFI4968	3/38	1,53	PPMB2540	3/36	2,77
PPEB2020	2/29	6,00	PPFB1080	3/37	0,98	PPFM1010	2/19	3,69	PPMB2560	3/36	3,43
PPEB2020	4/15	6,00	PPFB1540	3/37	0,76	PPFM1010	4/9	3,69	PPMB2580	3/36	-
PPEB2025	4/14	10,50	PPFB1560	3/37	1,06	PPFM1010	4/26	3,69	PPMB3010	3/36	5,53
PPEB2026	2/28	9,50	PPFB1580	3/37	1,41	PPFM1020	2/19	0,95	PPMB3012	3/36	-
PPEB2026	4/15	9,50	PPFB1840	3/37	7,00	PPFM1020	4/9	0,95	PPMB3040	3/36	3,09
PPEB2027	4/14	-	PPFB1860	3/37	10,00	PPFM1025	4/9	1,14	PPMB3060	3/36	3,91
PPEB2030	2/29	8,00	PPFB2004	3/37	7,50	PPFM1030	2/19	1,32	PPMB3080	3/36	4,68
PPEB2030	4/15	8,00	PPFB2006	3/37	12,00	PPFM1030	4/9	1,32	PPMB3512	3/36	-
PPEB2036	2/27	11,60	PPFB2040	3/37	0,92	PPFM1040	2/19	1,69	PPMB4010	3/36	6,85
PPEB2036	2/28	11,60	PPFB2060	3/37	1,37	PPFM1050	2/19	1,98	PPMB4040	3/36	3,48
PPEB2036	4/15	11,60	PPFB2080	3/37	1,80	PPFM1050	4/9	1,98	PPMB4060	3/36	4,57
PPEB2046	2/27	15,00	PPFB2540	3/37	1,19	PPFM1050	4/9	1,98	PPMB4080	3/36	5,56
PPEB2050	2/29	11,50	PPFB2560	3/37	1,64	PPFM1050	4/26	1,98	PPMB5001	3/36	5,71
PPEB2050	4/14	11,50	PPFB2580	3/37	2,20	PPFM1060	2/19	2,38	PPMB5004	3/36	4,04
PPEB2050	4/15	11,50	PPFB3040	3/37	1,30	PPFM1060	4/26	2,38	PPMB5006	3/36	5,35
PPEB2050	4/30	11,50	PPFB3060	3/37	1,94	PPFM1070	2/19	2,70	PPMB5008	3/36	6,64
PPEB2056	2/28	18,00	PPFB3080	3/37	2,60	PPFM1070	4/9	2,70	PPMB6010	3/36	9,66
PPEB2056	4/14	18,00	PPFB4040	3/37	1,72	PPFM1070	4/26	2,70	PPMB6040	3/36	4,56
PPEB2056	4/15	18,00	PPFB4060	3/37	2,52	PPFM1075	4/9	2,82	PPMB6060	3/36	5,98
PPEB2056	4/30	18,00	PPFB4080	3/37	3,50	PPFM1080	2/19	3,07	PPMB6080	3/36	7,71
PPEB2060	4/29	13,00	PPFB5004	3/37	2,13	PPFM1080	4/26	3,07	PPMF1540	3/22	0,63
PPEB2066	2/27	20,20	PPFB5006	3/37	3,17	PPFM1090	2/19	3,42	PPMF1560	3/22	0,86
PPEB2066	4/29	20,20	PPFB5040	3/37	0,30	PPFM1090	4/9	3,42	PPMF1580	3/22	1,14
PPEB2070	2/29	15,00	PPFB5060	3/37	0,44	PPFM1090	4/26	3,42	PPMF2040	3/22	0,81
PPEB2070	4/15	15,00	PPFB5080	3/37	0,61	PPFM1250	2/19	2,27	PPMF2060	3/22	1,20
PPEB2070	4/30	15,00	PPFB6040	3/37	2,51	PPFM1250	4/9	2,27	PPMF2080	3/22	1,55
PPEB2075	4/14	25,00	PPFB6060	3/37	3,63	PPFV1800	2/32	4,50	PPMF3040	3/22	1,05

System pro E power

List of codes

Code	Page	Weight KG	Code	Page	Weight KG	Code	Page	Weight KG	Code	Page	Weight KG
PPMF3060	3/22	1,62	PRVS1040	6/43	5,35	PRVS2581	6/38	1,06	PSAF0016	2/37	0,66
PPMF3080	3/22	2,10	PRVS1040	6/45	5,35	PRVS2582	6/39	1,33	PSBS0065	2/37	0,39
PPMU3060	5/36	1,89	PRVS1041	6/42	3,20	PRVS3010	6/40	4,15	PSCP0024	2/37	-
PPMU3080	5/36	2,43	PRVS1060	6/43	8,04	PRVS3041	6/34	0,57	PSCS0579	2/37	0,52
PPNL3010	4/24	-	PRVS1061	6/42	2,05	PRVS3041	6/38	0,57	PSHF1096	6/37	2,56
PPNL3060	4/24	2,14	PRVS1062	6/43	4,21	PRVS3060	6/40	2,40	PSHF1296	6/37	3,14
PPNL3080	4/24	-	PRVS1062	6/45	4,21	PRVS3061	6/34	0,96	PSHF6072	6/37	1,10
PPNL4010	4/24	-	PRVS1080	6/43	10,33	PRVS3061	6/38	0,96	PSHF6092	6/37	1,60
PPNL4060	4/24	-	PRVS1081	6/42	5,25	PRVS3062	6/39	1,18	PSHF8072	6/37	1,51
PPNL4080	4/24	-	PRVS1082	6/43	5,23	PRVS3080	6/40	3,20	PSHF8092	6/37	2,16
PPRA1820	2/28	14,00	PRVS1710	6/40	2,51	PRVS3081	6/34	1,29	PSHS1400	6/48	0,37
PPRA1820	4/15	14,00	PRVS1740	6/40	1,03	PRVS3081	6/38	1,29	PSHS1600	6/48	0,53
PPRA2020	2/28	16,00	PRVS1741	6/38	0,33	PRVS3082	6/39	1,58	PSHS1800	6/48	0,70
PPRA2020	4/15	16,00	PRVS1760	6/40	1,42	PRVS3125	6/40	5,09	PSHS1901	6/22	2,46
PPRB1820	4/14	15,50	PRVS1761	6/38	0,54	PRVS3501	6/40	5,90	PSHS1904	6/22	0,99
PPRB2020	4/14	17,00	PRVS1762	6/39	0,70	PRVS3510	6/40	4,48	PSHS1906	6/22	1,42
PPRS0150	6/23	0,09	PRVS1780	6/40	2,04	PRVS3541	6/34	0,68	PSHS1908	6/22	1,94
PPRS0200	6/23	0,05	PRVS1781	6/38	0,74	PRVS3561	6/34	1,09	PSHS2400	6/48	0,49
PPRS0200	6/28	0,05	PRVS1782	6/39	0,97	PRVS3581	6/34	1,48	PSHS2600	6/48	0,73
PPRS0250	6/23	0,08	PRVS2010	6/40	2,81	PRVS4041	6/34	0,79	PSHS2800	6/48	0,94
PPRS0250	6/28	0,08	PRVS2040	6/40	1,80	PRVS4061	6/34	1,23	PSHS4050	6/36	2,84
PPRS0300	6/23	0,10	PRVS2041	6/34	0,39	PRVS4081	6/34	1,78	PSHS4070	6/36	3,85
PPRS0300	6/28	0,10	PRVS2041	6/38	0,39	PRVS5041	6/34	0,97	PSHS4090	6/36	5,02
PPRS0350	6/23	0,15	PRVS2060	6/40	1,65	PRVS5061	6/34	1,52	PSHS6050	6/36	3,79
PPRS0350	6/28	0,15	PRVS2061	6/34	0,60	PRVS5081	6/34	2,13	PSHS6070	6/36	5,45
PPRS0400	6/23	0,13	PRVS2061	6/38	0,60	PRVS6041	6/34	1,16	PSHS6090	6/36	7,00
PPRS0400	6/28	0,13	PRVS2062	6/39	0,81	PRVS6061	6/34	1,86	PSHS8050	6/36	4,98
PPRS0450	6/23	0,15	PRVS2080	6/40	2,28	PRVS6081	6/34	2,57	PSHS8070	6/36	7,00
PPRS0450	6/28	0,15	PRVS2081	6/34	0,88	PRVS7010	6/43	9,11	PSHS8090	6/36	8,96
PPRS0500	6/23	0,18	PRVS2081	6/38	0,88	PRVS7040	6/43	3,93	PSHW1096	6/37	2,09
PPRS0500	6/28	0,18	PRVS2082	6/39	1,10	PRVS7041	6/34	1,37	PSHW1296	6/37	2,59
PPRS0600	6/23	0,21	PRVS2125	6/40	3,57	PRVS7041	6/42	1,37	PSHW5061	6/24	-
PPRS0600	6/28	0,21	PRVS2210	6/40	3,23	PRVS7060	6/43	5,43	PSHW5081	6/24	4,47
PPVS2200	6/22	0,36	PRVS2240	6/40	1,29	PRVS7061	6/34	2,27	PSHW6051	6/37	0,64
PPVS2250	6/22	0,45	PRVS2241	6/38	1,30	PRVS7061	6/42	2,27	PSHW6071	6/37	1,11
PPVS2300	6/22	1,00	PRVS2251	6/38	0,97	PRVS7062	6/43	2,95	PSHW6072	6/37	0,94
PPVS2350	6/22	0,62	PRVS2260	6/40	1,84	PRVS7080	6/43	7,26	PSHW6074	6/37	0,92
PPVS2400	6/22	1,43	PRVS2261	6/38	0,70	PRVS7081	6/34	3,10	PSHW6091	6/37	1,57
PPVS2450	6/22	1,61	PRVS2262	6/39	0,90	PRVS7081	6/42	3,10	PSHW6092	6/37	1,36
PPVS2500	6/22	0,87	PRVS2280	6/40	2,55	PRVS7082	6/43	3,20	PSHW6094	6/37	1,45
PPVS2600	6/22	2,07	PRVS2282	6/39	1,21	PRVS8010	6/43	10,41	PSHW8051	6/37	0,87
PPVS2700	6/22	2,45	PRVS2510	6/40	3,54	PRVS8040	6/43	4,29	PSHW8071	6/37	1,47
PRBE1243	3/39	5,81	PRVS2512	6/40	4,11	PRVS8040	6/45	4,29	PSHW8072	6/37	1,20
PRBE2232	3/39	5,42	PRVS2541	6/34	0,50	PRVS8041	6/42	1,64	PSHW8074	6/37	1,20
PRBE2233	3/39	5,35	PRVS2560	6/40	2,04	PRVS8060	6/43	6,44	PSHW8091	6/37	-
PRBS1220	6/45	2,62	PRVS2561	6/34	0,77	PRVS8061	6/42	2,56	PSHW8092	6/37	1,76
PRBS1240	6/45	5,09	PRVS2561	6/38	0,77	PRVS8062	6/43	3,69	PSHW8094	6/37	1,77
PRBS8220	6/45	2,10	PRVS2562	6/39	0,98	PRVS8062	6/45	3,69	PSRM1515	3/40	0,13
PRBS8240	6/45	4,00	PRVS2580	6/40	2,78	PRVS8080	6/43	8,40	PSVF6062	6/24	8,11
PRVS1010	6/43	13,25	PRVS2581	6/34	1,06	PRVS8081	6/42	3,47	PSVF6064	6/24	9,80
						PRVS8082	6/43	4,16	PSVF6082	6/24	12,96

Code	Page	Weight KG	Code	Page	Weight KG	Code	Page	Weight KG	Code	Page	Weight KG
PSVF6084	6/24	12,52	PSWV7126	6/24	20,04	PTBB3056	4/10	3,46	PTBB8020	2/22	3,73
PSVF7016	6/24	14,92	PTBB1020	2/22	4,50	PTBB3070	2/22	4,50	PTBB8026	2/20	3,48
PSVF7126	6/24	16,76	PTBB1020	4/11	4,50	PTBB3076	2/20	4,18	PTBB8030	2/22	5,00
PSVS0055	6/33	4,00	PTBB1026	2/20	4,69	PTBB3090	2/22	5,54	PTBB8036	2/20	5,01
PSVS0057	6/33	-	PTBB1026	4/10	4,69	PTBB3096	2/20	5,54	PTBB8050	2/22	7,40
PSVS0105	6/33	0,73	PTBB1030	2/22	6,00	PTBB4020	2/22	2,10	PTBB8050	4/27	7,40
PSVS0107	6/33	1,07	PTBB1030	4/11	6,00	PTBB4026	2/20	2,20	PTBB8056	2/20	7,43
PSVS0109	6/33	1,37	PTBB1036	2/20	6,08	PTBB4030	2/22	2,87	PTBB8056	4/26	7,43
PSVS0155	6/33	1,62	PTBB1036	4/10	6,08	PTBB4036	2/20	2,90	PTBB8070	2/22	9,85
PSVS0157	6/33	1,46	PTBB1050	2/22	9,00	PTBB4050	2/22	4,20	PTBB8070	4/27	9,85
PSVS0159	6/33	1,96	PTBB1050	4/11	9,00	PTBB4056	2/20	3,90	PTBB8076	2/20	9,76
PSVS0205	6/33	1,29	PTBB1050	4/27	9,00	PTBB4070	2/22	5,43	PTBB8076	4/26	9,76
PSVS0207	6/33	1,86	PTBB1056	2/20	9,20	PTBB4076	2/20	5,20	PTBB8090	2/22	12,50
PSVS0209	6/33	2,55	PTBB1056	4/10	9,20	PTBB4090	2/22	6,85	PTBB8090	4/27	12,50
PSVS0255	6/33	1,04	PTBB1056	4/26	9,20	PTBB4096	2/20	7,06	PTBB8096	2/20	12,49
PSVS0257	6/33	2,33	PTBB1070	2/22	12,00	PTBB5020	4/11	-	PTBB8096	4/26	12,49
PSVS0259	6/33	3,09	PTBB1070	4/11	12,00	PTBB5026	4/10	2,50	PTBB9090	2/21	13,50
PSVS0305	6/33	1,90	PTBB1070	4/27	12,00	PTBB5050	2/21	5,05	PTB01030	2/24	4,08
PSVS0307	6/33	2,69	PTBB1076	2/20	11,90	PTBB5050	4/10	5,05	PTB01030	4/12	4,08
PSVS0309	6/33	3,68	PTBB1076	4/10	11,90	PTBB5057	4/11	5,00	PTB01050	2/24	5,06
PSVS0505	6/33	0,46	PTBB1076	4/26	11,90	PTBB5070	4/11	6,50	PTB01050	4/12	5,06
PSVS0507	6/33	0,66	PTBB1090	2/22	14,50	PTBB5076	4/10	6,73	PTB01050	4/28	5,06
PSVS0509	6/33	0,85	PTBB1090	4/11	14,50	PTBB5090	4/11	8,00	PTB01070	2/24	5,77
PSVS2050	6/33	1,22	PTBB1090	4/27	14,50	PTBB5096	4/10	8,00	PTB01070	4/12	5,77
PSVS2070	6/33	1,74	PTBB1096	2/20	14,85	PTBB6020	2/22	2,98	PTB01070	4/28	5,77
PSVS2090	6/33	2,29	PTBB1096	4/10	14,85	PTBB6026	2/20	3,03	PTB01090	2/24	6,86
PSVS2550	6/33	1,51	PTBB1096	4/26	14,85	PTBB6030	2/22	3,93	PTB01090	4/12	6,86
PSVS2570	6/33	2,14	PTBB1220	2/22	5,50	PTBB6036	2/20	3,95	PTB01090	4/28	6,86
PSVS2590	6/33	2,82	PTBB1220	4/11	5,50	PTBB6050	2/22	5,80	PTB01230	4/12	6,00
PSVS3050	6/33	1,81	PTBB1230	4/11	7,50	PTBB6050	4/27	5,80	PTB01250	4/12	7,00
PSVS3070	6/33	2,55	PTBB1250	4/11	11,00	PTBB6056	2/20	5,90	PTB01270	4/12	8,50
PSVS3090	6/33	3,38	PTBB1270	4/11	15,00	PTBB6056	4/26	5,90	PTB01290	2/24	-
PSVS3550	6/33	2,03	PTBB1290	2/22	18,00	PTBB6070	2/22	7,60	PTB01290	4/12	-
PSVS3570	6/33	2,97	PTBB1290	4/11	18,00	PTBB6070	4/27	7,60	PTB02520	4/12	-
PSVS3590	6/33	3,86	PTBB2520	4/11	1,50	PTBB6076	2/20	7,66	PTB02530	4/12	2,00
PSVS4050	6/33	2,33	PTBB2526	4/10	1,50	PTBB6076	4/26	7,66	PTB02550	4/12	2,60
PSVS4070	6/33	3,35	PTBB2530	4/11	2,00	PTBB6090	2/22	9,50	PTB02570	4/12	3,30
PSVS4090	6/33	4,41	PTBB2536	4/10	-	PTBB6090	4/27	9,50	PTB02590	4/12	4,00
PSVS5050	6/33	2,83	PTBB2550	4/11	3,00	PTBB6096	2/20	9,25	PTB03020	2/24	1,29
PSVS5070	6/33	4,13	PTBB2556	4/10	3,07	PTBB6096	4/26	9,25	PTB03030	2/24	2,06
PSVS5090	6/33	5,32	PTBB2570	4/11	4,00	PTBB7070	2/21	9,00	PTB03050	2/24	2,78
PSVS6050	6/33	3,61	PTBB2576	4/10	4,08	PTBB7520	4/11	3,50	PTB03050	4/12	2,78
PSVS6070	6/33	5,13	PTBB2590	4/11	5,00	PTBB7526	4/10	3,50	PTB03070	2/24	3,08
PSVS6090	6/33	6,73	PTBB2596	4/10	5,00	PTBB7530	4/11	4,50	PTB03090	2/24	3,71
PSVW5061	6/24	6,38	PTBB3020	2/22	1,75	PTBB7536	4/10	-	PTB04020	2/24	1,63
PSVW5081	6/24	12,39	PTBB3026	2/20	1,79	PTBB7550	4/11	7,00	PTB04030	2/24	2,46
PSVW6062	6/24	12,26	PTBB3030	2/22	2,33	PTBB7556	4/10	7,17	PTB04050	2/24	2,80
PSVW6064	6/24	11,52	PTBB3036	2/20	2,36	PTBB7570	4/11	9,50	PTB04070	2/24	3,47
PSVW6082	6/24	15,34	PTBB3050	2/22	3,45	PTBB7576	4/10	9,50	PTB04090	2/24	4,25
PSVW6084	6/24	14,80	PTBB3050	4/11	3,45	PTBB7590	4/11	11,50	PTB05020	4/12	2,50
PSVW7016	6/24	16,73	PTBB3056	2/20	3,46	PTBB7596	4/10	11,50	PTB05050	4/12	3,55

System pro E power

List of codes

Code	Page	Weight KG	Code	Page	Weight KG	Code	Page	Weight KG	Code	Page	Weight KG
PTB05070	4/12	4,29	PTHS1092	6/30	8,57	PTRS1601	5/34	1,55	PVBT5404	3/31	4,91
PTB05090	4/12	-	PTHS1292	6/30	10,57	PTRS2001	5/34	1,74	PVBT5406	3/31	4,50
PTB06020	2/24	2,30	PTHS2030	6/29	0,85	PTVB1091	6/27	8,31	PVBT5412	3/31	5,86
PTB06030	2/24	3,01	PTHS2050	6/29	1,32	PTVB1091	6/42	8,31	PVBT5414	3/31	4,47
PTB06050	2/24	3,95	PTHS2052	6/31	0,75	PTVB1091	6/45	8,31	PVBT5423	3/31	5,40
PTB06050	4/28	3,95	PTHS2070	6/29	1,80	PTVS1001	6/27	2,06	PVBT5426	3/31	4,44
PTB06070	2/24	4,25	PTHS2072	6/31	1,25	PTVS1020	6/26	2,51	PVBT5428	3/31	5,25
PTB06070	4/28	4,25	PTHS2090	6/29	2,35	PTVS1030	6/26	3,27	PVBT6312	3/31	6,69
PTB06090	2/24	5,01	PTHS2092	6/31	1,72	PTVS1050	6/26	5,37	PVBT6314	3/31	5,01
PTB06090	4/28	5,01	PTHS3030	6/29	1,46	PTVS1052	6/27	2,95	PVBT6401	3/31	5,21
PTB07520	4/12	3,00	PTHS3050	6/29	2,28	PTVS1070	6/26	7,44	PVBT6404	3/31	4,98
PTB07530	4/12	3,50	PTHS3052	6/30	1,36	PTVS1072	6/27	7,89	PVBT6405	3/31	5,14
PTB07550	4/12	4,47	PTHS3070	6/29	3,34	PTVS1091	6/27	7,26	PVBX1401	3/30	4,13
PTB07570	4/12	5,29	PTHS3072	6/30	2,27	PTVS8001	6/27	1,67	PVBX1404	3/30	4,09
PTB07590	4/12	6,00	PTHS3090	6/29	4,24	PTVS8020	6/26	2,00	PVBX1405	3/30	4,13
PTB08020	2/24	3,00	PTHS3092	6/30	3,28	PTVS8030	6/26	2,83	PVBX1407	3/30	4,18
PTB08030	2/24	3,76	PTHS4030	6/28	1,80	PTVS8050	6/26	4,29	PVBX1409	3/30	4,51
PTB08050	2/24	4,65	PTHS4030	6/29	1,80	PTVS8052	6/27	2,30	PVBX1423	3/30	4,20
PTB08050	4/28	4,65	PTHS4050	6/28	-	PTVS8070	6/26	5,95	PVBX1427	3/30	4,09
PTB08070	2/24	5,03	PTHS4050	6/29	-	PTVS8072	6/27	4,06	PVBX2400	3/30	4,07
PTB08070	4/28	5,03	PTHS4052	6/30	1,46	PTVS8091	6/27	5,71	PVBX2401	3/30	4,04
PTB08090	2/24	5,93	PTHS4070	6/28	4,00	PUCM1800	2/16	3,00	PVBX2404	3/30	4,11
PTB08090	4/28	5,93	PTHS4070	6/29	4,00	PUCM2000	2/16	3,50	PVBX2405	3/30	4,10
PTBS1001	6/27	2,65	PTHS4072	6/30	2,93	PUCS1800	2/16	2,83	PVBX2407	3/30	4,08
PTBS1020	6/26	2,82	PTHS4092	6/30	4,09	PUCS2000	2/16	-	PVBX2409	3/30	4,42
PTBS1030	6/26	3,86	PTHS4152	6/30	1,74	PUKI1800	3/20	2,87	PVBX2410	3/30	4,10
PTBS1050	6/26	6,53	PTHS4172	6/30	2,87	PUKI1800	6/22	2,87	PVBX2412	3/30	4,51
PTBS1052	6/27	3,43	PTHS4190	6/29	5,12	PUKI1800	6/26	2,87	PVBX2417	3/30	4,35
PTBS1052	6/42	3,43	PTHS4192	6/30	4,08	PUKI1800	6/32	2,87	PVBX2423	3/30	4,57
PTBS1052	6/45	3,43	PTHS4230	6/29	1,56	PUKI1800	6/46	2,87	PVBX2427	3/30	4,08
PTBS1070	6/26	8,92	PTHS4250	6/29	2,88	PUKI1800	4/25	2,87	PVBX3401	3/30	4,06
PTBS1072	6/27	5,75	PTHS4252	6/31	1,42	PUKI2000	3/20	3,30	PVBX3404	3/30	3,98
PTBS1072	6/42	5,75	PTHS4270	6/29	3,40	PUKI2000	6/22	3,30	PVBX3405	3/30	4,04
PTBS1072	6/45	5,75	PTHS4272	6/31	2,37	PUKI2000	6/26	3,30	PVBX3407	3/30	4,03
PTBS8001	6/27	2,11	PTHS4290	6/29	4,39	PUKI2000	6/32	3,30	PVBX3409	3/30	-
PTBS8020	6/26	2,24	PTHS4292	6/31	3,35	PUKI2000	6/46	3,30	PVBX3423	3/30	5,03
PTBS8030	6/26	3,10	PTHS6030	6/28	2,42	PUKI2000	4/25	3,30	PVBX3427	3/30	4,11
PTBS8050	6/26	5,05	PTHS6050	6/28	3,99	PUPM1800	2/15	15,38	PVBX4400	3/30	-
PTBS8052	6/27	2,30	PTHS6052	6/30	2,41	PUPM1800	4/8	15,38	PVBX4401	3/30	4,06
PTBS8052	6/42	2,30	PTHS6070	6/28	5,71	PUPM1800	4/25	15,38	PVBX4404	3/30	4,13
PTBS8052	6/45	2,30	PTHS6072	6/30	4,05	PUPM2000	2/15	16,50	PVBX4405	3/30	4,16
PTBS8070	6/26	6,93	PTHS6092	6/30	5,65	PUPM2000	4/8	16,50	PVBX4407	3/30	6,13
PTBS8072	6/27	4,56	PTHS8030	6/28	3,16	PUPM2000	4/25	16,50	PVBX4409	3/30	4,57
PTBS8072	6/42	4,56	PTHS8050	6/28	5,07	PUPS1800	2/15	-	PVBX4410	3/30	4,47
PTBS8072	6/45	4,56	PTHS8052	6/30	3,12	PUPS2000	2/15	16,00	PVBX4412	3/30	-
PTBS8091	6/27	6,64	PTHS8070	6/28	7,08	PVBE1241	3/34	4,79	PVBX4417	3/30	4,80
PTBS8091	6/42	6,64	PTHS8072	6/30	5,11	PVBT4404	3/30	5,01	PVBX4423	3/30	3,87
PTBS8091	6/45	6,64	PTHS8092	6/30	7,15	PVBT4406	3/30	4,55	PVBX4427	3/30	4,41
PTHS1052	6/30	3,84	PTRN1951	5/34	0,35	PVBT4423	3/30	5,40	PVCE1240	3/34	6,82
PTHS1072	6/30	6,24	PTRS1201	5/34	1,35	PVBT5319	3/31	-	PVCE1241	3/34	6,92

Code	Page	Weight KG	Code	Page	Weight KG	Code	Page	Weight KG	Code	Page	Weight KG
PVCE2441	3/34	6,88	PVCX3423	3/32	7,00	PVDX4807	3/33	7,17			
PVCE2442	3/34	7,16	PVCX3427	3/32	5,56	PVFE1263	3/34	10,61			
PVCE2450	3/34	6,88	PVCX3607	3/31	5,65	PVFE6230	3/34	24,06			
PVCE4350	3/34	-	PVCX3707	3/31	5,43	PVFE6231	3/34	25,63			
PVCT4404	3/32	6,77	PVCX4400	3/32	6,27	PVFT5710	3/33	9,10			
PVCT4406	3/32	6,25	PVCX4401	3/32	5,55	PVFT5712	3/33	11,40			
PVCT4423	3/32	7,46	PVCX4404	3/32	5,54	PVFT5810	3/33	8,89			
PVCT5307	3/32	-	PVCX4405	3/32	5,61	PVFT5812	3/33	11,28			
PVCT5404	3/32	6,71	PVCX4407	3/32	6,12	PVFT6610	3/33	11,48			
PVCT5406	3/32	6,24	PVCX4409	3/32	6,67	PVFT6612	3/33	13,92			
PVCT5412	3/32	7,82	PVCX4410	3/32	6,24	PVFT7633	3/33	10,88			
PVCT5414	3/32	6,07	PVCX4412	3/32	6,77	PVGE6230	3/34	26,86			
PVCT5423	3/32	7,45	PVCX4417	3/32	-	PVGE6231	3/34	30,60			
PVCT5426	3/32	6,20	PVCX4423	3/32	6,86	TS4011	5/41	2,00			
PVCT5428	3/32	7,49	PVCX4427	3/32	6,12	TS4012	5/41	2,00			
PVCT5601	3/32	-	PVCX4601	3/32	5,66	TS4013	5/41	2,00			
PVCT5710	3/32	-	PVCX4607	3/32	5,90	VB7012	2/37	0,52			
PVCT6401	3/32	8,86	PVCX4701	3/32	5,53	VB7035	2/37	0,60			
PVCT6404	3/32	7,37	PVCX4707	3/32	5,70	ZN1041	2/19	1,50			
PVCT6405	3/32	6,90	PVDE1240	3/34	9,15						
PVCT6412	3/32	9,38	PVDE1241	3/34	8,97						
PVCT6414	3/32	7,32	PVDE1262	3/34	8,14						
PVCT7413	3/32	6,88	PVDE2440	3/34	9,15						
PVCT7419	3/32	7,44	PVDE2441	3/34	10,81						
PVCX1401	3/31	5,67	PVDT5404	3/33	8,51						
PVCX1404	3/31	5,65	PVDT5406	3/33	8,11						
PVCX1405	3/31	5,70	PVDT5412	3/33	9,98						
PVCX1407	3/31	5,69	PVDT5414	3/33	7,84						
PVCX1409	3/31	6,08	PVDT5423	3/33	9,79						
PVCX1423	3/31	5,78	PVDT5426	3/33	7,98						
PVCX1427	3/31	5,62	PVDT5428	3/33	9,56						
PVCX1707	3/31	5,76	PVDT5610	3/33	7,53						
PVCX2400	3/31	5,56	PVDT5612	3/33	9,58						
PVCX2401	3/31	5,65	PVDT5701	3/33	-						
PVCX2404	3/31	4,89	PVDT5810	3/33	-						
PVCX2405	3/31	5,67	PVDT6401	3/33	8,83						
PVCX2407	3/31	5,56	PVDT6404	3/33	9,32						
PVCX2409	3/31	6,76	PVDT6405	3/33	5,57						
PVCX2410	3/31	5,64	PVDT6412	3/33	11,78						
PVCX2412	3/31	6,09	PVDT6414	3/33	9,64						
PVCX2417	3/31	6,22	PVDT7413	3/33	7,88						
PVCX2423	3/31	6,25	PVDT7419	3/33	8,90						
PVCX2427	3/31	5,63	PVDX1807	3/33	-						
PVCX2701	3/31	5,65	PVDX2801	3/33	6,96						
PVCX2707	3/31	6,21	PVDX2807	3/33	6,52						
PVCX3401	3/31	5,51	PVDX3707	3/33	7,04						
PVCX3404	3/31	5,59	PVDX3807	3/33	-						
PVCX3405	3/31	5,61	PVDX4701	3/33	6,87						
PVCX3407	3/31	5,58	PVDX4707	3/33	7,16						
PVCX3409	3/32	5,95	PVDX4801	3/33	6,85						

Contacts

ABB SACE

A division of ABB S.p.A.

Automation and Distribution Boards

Via Italia, 58

23846 Garbagnate Monastero (LC) - Italy

Tel: +39 031 3570.111

Fax: +39 031 3570.228

www.abb.com/lowvoltage

The data and illustrations are not binding. We reserve the right to change the contents of this document without prior notice, in the course of technical development of the product.

Copyright 2015 ABB. All rights reserved.

1STC803005D0203 - 03 .2015